

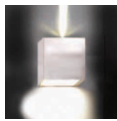









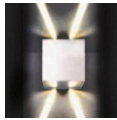

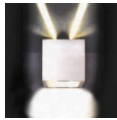









	LED IND 3130	Page		News BEAM 2 ONE WAY IP40 BEAM 100°133	Page		SPOT MINI BEAM137	Page
	LED IND 6130	Page		News BEAM 2 ONE WAY IP40 BEAM 40°133	Page		SPOT MINI BEAM137	Page
	LED MINI SEMI CIRCULAR 12V AC130	Page		News BEAM 1 TWO WAY IP40 BEAM 40°/ 100°.....134	Page		SPOT MINI BEAM137	Page
	LED MINI CLEAR GLASS 12V AC131	Page		News BEAM 1 TWO WAY IP40 BEAM 100°/ 100°.....134	Page			
	LED MINI OPAL GLASS 12V AC131	Page		News BEAM 1 TWO WAY IP40 BEAM 40°/ 40°.....134	Page			
	LED MINI SQUARE OPAL GLASS 12V AC131	Page		News BEAM 2 TWO WAY IP40 BEAM 40°/ 100°.....135	Page			
	LED MINI 2 WINDOWS 12V AC132	Page		News BEAM 2 TWO WAY IP40 BEAM 100°/ 100°.....135	Page			
	LED MINI 8 WINDOWS 12V AC132	Page		News BEAM 2 TWO WAY IP40 BEAM 40°/ 40°.....135	Page			
	News BEAM 1 ONE WAY IP40 BEAM 100°133	Page		SPOT MINI BEAM136	Page			
	News BEAM 1 ONE WAY IP40 BEAM 100°133	Page		SPOT MINI BEAM136	Page			
	News BEAM 1 ONE WAY IP40 BEAM 40°133	Page		SPOT MINI BEAM136	Page			

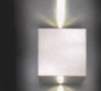

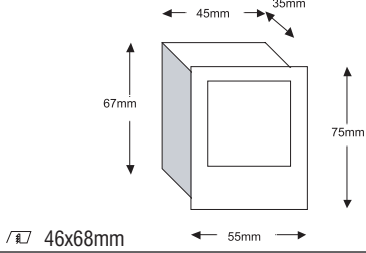

- Steel body
- Clear protective glass.

LED IND 3
(RECESSED LUMINAIRES)



						PRICE LIST	
CODE	DESCRIPTION	COLOUR LED	WATT	LED	COLOUR	Without Transformer	
851315	LED IND 3	White	0,5	3	Inox		+ Transformer Selection 12V
851335	LED IND 3	Blue	0,5	3	Inox		+ Transformer Selection 12V
851355	LED IND 3	Yellow	0,5	3	Inox		+ Transformer Selection 12V
851325	LED IND 3	Red	0,5	3	Inox		+ Transformer Selection 12V
851345	LED IND 3	Green	0,5	3	Inox		+ Transformer Selection 12V

• Galvanized steel outer casing for wall installation Code: 805203 - Price List:

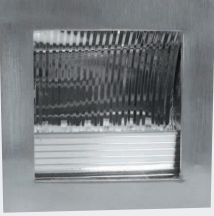

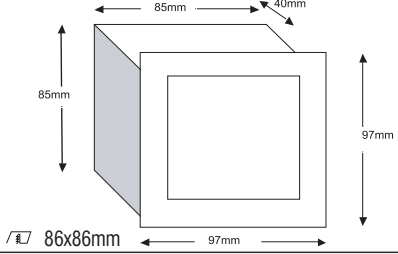

- Steel body
- Clear protective glass.

LED IND 6
(RECESSED LUMINAIRES)



						PRICE LIST	
CODE	DESCRIPTION	COLOUR LED	WATT	LED	COLOUR	Without Transformer	
851365	LED IND 6	White	1,2	6	Inox		+ Transformer Selection 12V
851385	LED IND 6	Blue	1,2	6	Inox		+ Transformer Selection 12V
851405	LED IND 6	Yellow	1,2	6	Inox		+ Transformer Selection 12V
851375	LED IND 6	Red	1,2	6	Inox		+ Transformer Selection 12V
851395	LED IND 6	Green	1,2	6	Inox		+ Transformer Selection 12V

• Galvanized steel outer casing for wall installation Code: 805204 - Price List:

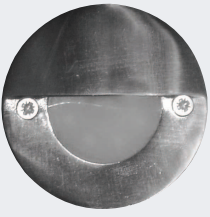

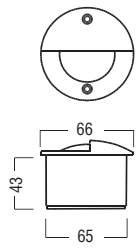

- LED Lighting with the possibility of different directional light and colour
- Die-cast aluminium body in inox colour.
- Plastic outer casing
- Long life with zero maintenance.
- Opal protective glass

LED MINI SEMI CIRCULAR 12V AC
(RECESSED LUMINAIRES)



						PRICE LIST	
CODE	DESCRIPTION	COLOUR LED	WATT	LED	COLOUR	Without Transformer	
851155	770940	Yellow	1,6	5	Inox		+ Transformer Selection 12V
851145	770941	Green	1,6	5	Inox		+ Transformer Selection 12V
851125	770942	Red	1,6	5	Inox		+ Transformer Selection 12V
851135	770943	Blue	1,6	5	Inox		+ Transformer Selection 12V
851115	770944	White	1,6	5	Inox		+ Transformer Selection 12V

• For installation in false ceiling, the LED includes hook support Code: 805201 - Price List:

- LED Lighting with the possibility of different directional light and colour
- Die-cast aluminium body in inox colour.
- Plastic outercasing
- Long life with zero maintenance.
- Opal protective glass

LED MINI CLEAR GLASS 12V AC
(RECESSED LUMINAIRES)

						PRICE LIST	
CODE	DESCRIPTION	COLOUR LED	WATT	LED	COLOUR	Without Transformer	
851305	771095	Yellow	1,6	9	Inox		+ Transformer Selection 12V
851295	771096	Green	1,6	9	Inox		+ Transformer Selection 12V
851275	771097	Red	1,6	9	Inox		+ Transformer Selection 12V
851285	771098	Blue	1,6	9	Inox		+ Transformer Selection 12V
851265	771099	White	1,6	9	Inox		+ Transformer Selection 12V

• For installation in **false ceiling**, the LED includes hook support Code: 805201 - Price List:

- LED Lighting with the possibility of different directional light and colour
- Die-cast aluminium body in inox colour.
- Plastic outercasing
- Long life with zero maintenance.
- Opal protective glass

LED MINI OPAL GLASS 12V AC
(RECESSED LUMINAIRES)

						PRICE LIST	
CODE	DESCRIPTION	COLOUR LED	WATT	LED	COLOUR	Without Transformer	
851255	771090	Yellow	1,6	9	Inox		+ Transformer Selection 12V
851245	771091	Green	1,6	9	Inox		+ Transformer Selection 12V
851225	771092	Red	1,6	9	Inox		+ Transformer Selection 12V
851235	771093	Blue	1,6	9	Inox		+ Transformer Selection 12V
851215	771094	White	1,6	9	Inox		+ Transformer Selection 12V



• For installation in **false ceiling**, the LED includes hook support Code: 805201 - Price List:



- LED Lighting with the possibility of different directional light and colour
- Die-cast aluminium body in inox colour.
- Plastic outercasing
- Long life with zero maintenance.
- Opal protective glass

LED MINI SQUARE OPAL GLASS 12V AC
(RECESSED LUMINAIRES)

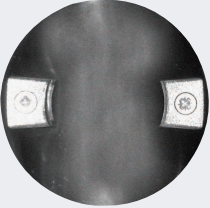
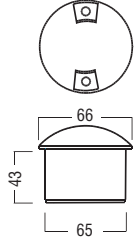
						PRICE LIST	
CODE	DESCRIPTION	COLOUR LED	WATT	LED	COLOUR	Without Transformer	
851055	770930	Yellow	1,6	9	Inox		+ Transformer Selection 12V
851045	770931	Green	1,6	9	Inox		+ Transformer Selection 12V
851025	770932	Red	1,6	9	Inox		+ Transformer Selection 12V
851035	770933	Blue	1,6	9	Inox		+ Transformer Selection 12V
851015	770934	White	1,6	9	Inox		+ Transformer Selection 12V

• For installation in **false ceiling**, the LED includes hook support Code: 805201 - Price List:

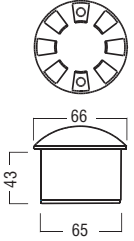
		<ul style="list-style-type: none"> • LED Lighting with the possibility of different directional light and colour • Die-cast aluminium body in inox colour. • Plastic outercasing • Long life with zero maintenance. 	LED MINI 2 WINDOWS 12V AC (RECESSED LUMINAIRES)			
						
PRICE LIST						
CODE	DESCRIPTION	COLOUR LED	WATT	LED	COLOUR	Without Transformer
851105	770945	Yellow	1,6	4	Inox	+ Transformer Selection 12V
851095	770946	Green	1,6	4	Inox	+ Transformer Selection 12V
851075	770947	Red	1,6	4	Inox	+ Transformer Selection 12V
851085	770948	Blue	1,6	4	Inox	+ Transformer Selection 12V
851065	770949	White	1,6	4	Inox	+ Transformer Selection 12V
<ul style="list-style-type: none"> • For installation in false ceiling, the LED includes hook support Code: 805201 - Price List: 						

		<ul style="list-style-type: none"> • LED Lighting with the possibility of different directional light and colour • Die-cast aluminium body in inox colour. • Plastic outercasing • Long life with zero maintenance. 	LED MINI 8 WINDOWS 12V AC (RECESSED LUMINAIRES)			
						
PRICE LIST						
CODE	DESCRIPTION	COLOUR LED	WATT	LED	COLOUR	Without Transformer
851205	770935	Yellow	1,6	8	Inox	+ Transformer Selection 12V
851195	770936	Green	1,6	8	Inox	+ Transformer Selection 12V
851175	770937	Red	1,6	8	Inox	+ Transformer Selection 12V
851185	770938	Blue	1,6	8	Inox	+ Transformer Selection 12V
851165	770939	White	1,6	8	Inox	+ Transformer Selection 12V
<ul style="list-style-type: none"> • For installation in false ceiling, the LED includes hook support Code: 805201 - Price List: 						

Colour Codes:

Beam 100°

QT 14 OSRAM: HALOPIN
G9 PHILIPS: CLICKLINE

MEGAMAN: CFL G9

- Aluminium body
- Transparent protection glass.
- Beam distribution frame from aluminium.

BEAM 1 - ONE WAY IP40
(WALL LIGHTING)

CE F IP 40

850°C

PRICE LIST

CODE	DESCRIPTION	COLOUR
85718	BEAM1 - ONE WAY IP40 beam 100° 1x max.60W QT 14 or 7W CFL / G9	White, Titan, Black
85718	BEAM1 - ONE WAY IP40 beam 100° 1x max.60W QT 14 or 7W CFL / G9	Chrome, matt Alum.
857180	BEAM1 - ONE WAY IP40 beam 100° 1x max.60W QT 14 or 7W CFL / G9	Colours

Beam 40°

QT 14 OSRAM: HALOPIN
G9 PHILIPS: CLICKLINE

MEGAMAN: CFL G9

- Aluminium body
- Transparent protection glass.
- Beam distribution frame from aluminium.

BEAM 1 - ONE WAY IP40
(WALL LIGHTING)

CE F IP 40

850°C

PRICE LIST

CODE	DESCRIPTION	COLOUR
85717	BEAM1 - ONE WAY IP40 beam 40° 1x max.60W QT 14 or 7W CFL / G9	White, Titan, Black
85717	BEAM1 - ONE WAY IP40 beam 40° 1x max.60W QT 14 or 7W CFL / G9	Chrome, matt Alum.
857170	BEAM1 - ONE WAY IP40 beam 40° 1x max.60W QT 14 or 7W CFL / G9	Colours

Beam 100°

QT 14 OSRAM: HALOPIN
G9 PHILIPS: CLICKLINE

MEGAMAN: CFL G9

- Aluminium body
- Transparent protection glass.
- Beam distribution frame from aluminium.

BEAM 2 - ONE WAY IP40
(WALL LIGHTING)

CE F IP 40

850°C

PRICE LIST

CODE	DESCRIPTION	COLOUR
85720	BEAM2 - ONE WAY IP40 beam 100° 1x max.60W QT 14 or 7W CFL / G9	White, Titan, Black
85720	BEAM2 - ONE WAY IP40 beam 100° 1x max.60W QT 14 or 7W CFL / G9	Chrome, matt Alum.
857200	BEAM2 - ONE WAY IP40 beam 100° 1x max.60W QT 14 or 7W CFL / G9	Colours

Beam 40°

QT 14 OSRAM: HALOPIN
G9 PHILIPS: CLICKLINE

MEGAMAN: CFL G9

- Aluminium body
- Transparent protection glass.
- Beam distribution frame from aluminium.

BEAM 2 - ONE WAY IP40
(WALL LIGHTING)

CE F IP 40

850°C

PRICE LIST

CODE	DESCRIPTION	COLOUR
85719	BEAM2 - ONE WAY IP40 beam 40° 1x max.60W QT 14 or 7W CFL / G9	White, Titan, Black
85719	BEAM2 - ONE WAY IP40 beam 40° 1x max.60W QT 14 or 7W CFL / G9	Chrome, matt Alum.
857190	BEAM2 - ONE WAY IP40 beam 40° 1x max.60W QT 14 or 7W CFL / G9	Colours

Colour Codes:

0 Colours 1 White 2 Titan 3 Black 4 Chrome 5 matt Alum.



Beam 40° / 100°

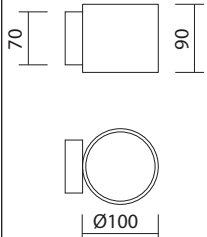

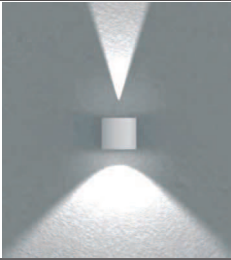

QT 14 OSRAM: HALOPIN
PHILIPS: CLICKLINE

G9 MEGAMAN: CFL G9

- Aluminium body
- Transparent protection glass.
- Beam distribution frame from aluminium.

BEAM 1 - TWO WAY IP40
(WALL LIGHTING)

CE

F

IP 40

850°C

CODE	DESCRIPTION	COLOUR
85711	BEAM1 - TWO WAY IP40 beam 40° / 100°	1x max.60W QT 14 or 7W CFL / G9
85711	BEAM1 - TWO WAY IP40 beam 40° / 100°	1x max.60W QT 14 or 7W CFL / G9
857110	BEAM1 - TWO WAY IP40 beam 40° / 100°	1x max.60W QT 14 or 7W CFL / G9



Beam 100° / 100°

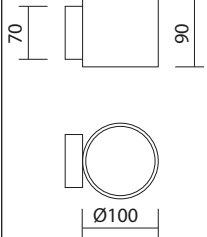

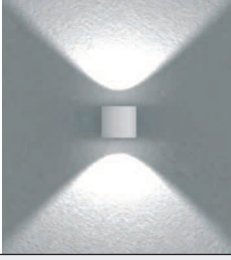

QT 14 OSRAM: HALOPIN
PHILIPS: CLICKLINE

G9 MEGAMAN: CFL G9

- Aluminium body
- Transparent protection glass.
- Beam distribution frame from aluminium.

BEAM 1 - TWO WAY IP40
(WALL LIGHTING)

CE

F

IP 40

850°C

CODE	DESCRIPTION	COLOUR
85712	BEAM1 - TWO WAY IP40 beam 100° / 100°	1x max.60W QT 14 or 7W CFL / G9
85712	BEAM1 - TWO WAY IP40 beam 100° / 100°	1x max.60W QT 14 or 7W CFL / G9
857120	BEAM1 - TWO WAY IP40 beam 100° / 100°	1x max.60W QT 14 or 7W CFL / G9



Beam 40° / 40°

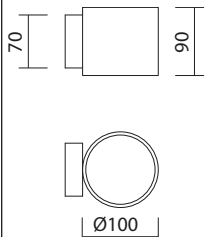

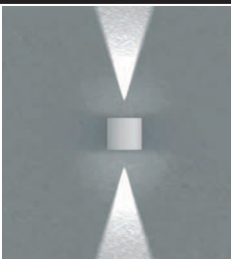

QT 14 OSRAM: HALOPIN
PHILIPS: CLICKLINE

G9 MEGAMAN: CFL G9

- Aluminium body
- Transparent protection glass.
- Beam distribution frame from aluminium.

BEAM 1 - TWO WAY IP40
(WALL LIGHTING)

CE

F

IP 40

850°C

CODE	DESCRIPTION	COLOUR
85713	BEAM1 - TWO WAY IP40 beam 40° / 40°	1x max.60W QT 14 or 7W CFL / G9
85713	BEAM1 - TWO WAY IP40 beam 40° / 40°	1x max.60W QT 14 or 7W CFL / G9
857130	BEAM1 - TWO WAY IP40 beam 40° / 40°	1x max.60W QT 14 or 7W CFL / G9



Beam 40° / 100°

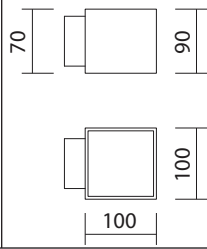

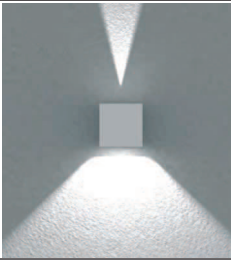



QT 14 OSRAM: HALOPIN
PHILIPS: CLICKLINE

G9 MEGAMAN: CFL G9

- Aluminium body
- Transparent protection glass.
- Beam distribution frame from aluminium.

BEAM 2 - TWO WAY IP40
(WALL LIGHTING)





850°C

CODE	DESCRIPTION	COLOUR
85714	BEAM2 - TWO WAY IP40 beam 40° / 100°	1x max.60W QT 14 or 7W CFL / G9
85714	BEAM2 - TWO WAY IP40 beam 40° / 100°	White, Titan, Black
85714	BEAM2 - TWO WAY IP40 beam 40° / 100°	1x max.60W QT 14 or 7W CFL / G9
85714	BEAM2 - TWO WAY IP40 beam 40° / 100°	Chrome, matt Alum.
857140	BEAM2 - TWO WAY IP40 beam 40° / 100°	1x max.60W QT 14 or 7W CFL / G9
857140	BEAM2 - TWO WAY IP40 beam 40° / 100°	Colours

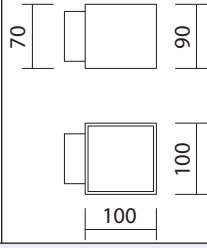

Beam 100° / 100°



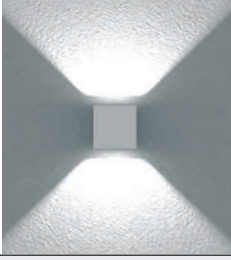



QT 14 OSRAM: HALOPIN
PHILIPS: CLICKLINE

G9 MEGAMAN: CFL G9

- Aluminium body
- Transparent protection glass.
- Beam distribution frame from aluminium.

BEAM 2 - TWO WAY IP40
(WALL LIGHTING)





850°C

CODE	DESCRIPTION	COLOUR
85715	BEAM2 - TWO WAY IP40 beam 100° / 100°	1x max.60W QT 14 or 7W CFL / G9
85715	BEAM2 - TWO WAY IP40 beam 100° / 100°	White, Titan, Black
85715	BEAM2 - TWO WAY IP40 beam 100° / 100°	1x max.60W QT 14 or 7W CFL / G9
85715	BEAM2 - TWO WAY IP40 beam 100° / 100°	Chrome, matt Alum.
857150	BEAM2 - TWO WAY IP40 beam 100° / 100°	1x max.60W QT 14 or 7W CFL / G9
857150	BEAM2 - TWO WAY IP40 beam 100° / 100°	Colours

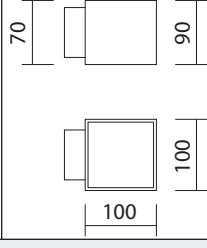

Beam 40° / 40°



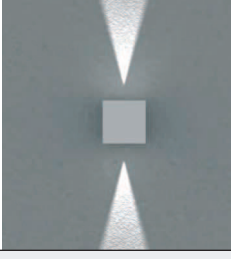



QT 14 OSRAM: HALOPIN
PHILIPS: CLICKLINE

G9 MEGAMAN: CFL G9

- Aluminium body
- Transparent protection glass.
- Beam distribution frame from aluminium.

BEAM 2 - TWO WAY IP40
(WALL LIGHTING)

850°C

CODE	DESCRIPTION	COLOUR
85716	BEAM2 - TWO WAY IP40 beam 40° / 40°	1x max.60W QT 14 or 7W CFL / G9
85716	BEAM2 - TWO WAY IP40 beam 40° / 40°	White, Titan, Black
85716	BEAM2 - TWO WAY IP40 beam 40° / 40°	1x max.60W QT 14 or 7W CFL / G9
85716	BEAM2 - TWO WAY IP40 beam 40° / 40°	Chrome, matt Alum.
857160	BEAM2 - TWO WAY IP40 beam 40° / 40°	1x max.60W QT 14 or 7W CFL / G9
857160	BEAM2 - TWO WAY IP40 beam 40° / 40°	Colours

Colour Codes:

0 Colours 1 White 2 Titan 3 Black 4 Chrome 5 matt Alum.



		OSRAM: HALOPIN PHILIPS: CLICKLINE	SPOT MINI BEAM Two way - narrow beam (WALL LIGHTING)
PRICE LIST			
CODE	DESCRIPTION	COLOUR	
85703	G903 1x40W QT 14 / G9	White, Titan	
85703	G903 1x40W QT 14 / G9	Chrome, matt Alum., Gold	



		OSRAM: HALOPIN PHILIPS: CLICKLINE	SPOT MINI BEAM Three way - narrow beam (WALL LIGHTING)
PRICE LIST			
CODE	DESCRIPTION	COLOUR	
85704	G904 1x40W QT 14 / G9	White, Titan	
85704	G904 1x40W QT 14 / G9	Chrome, matt Alum., Gold	

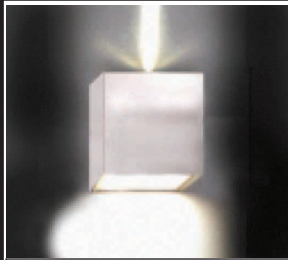
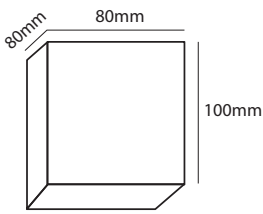

		OSRAM: HALOPIN PHILIPS: CLICKLINE	SPOT MINI BEAM Four way cross - narrow beam (WALL LIGHTING)
PRICE LIST			
CODE	DESCRIPTION	COLOUR	
85705	G905 1x40W QT 14 / G9	White, Titan	
85705	G905 1x40W QT 14 / G9	Chrome, matt Alum., Gold	

Colour Codes:

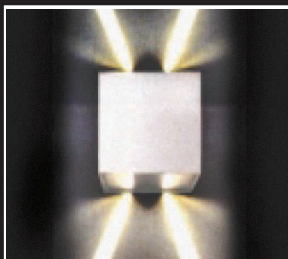
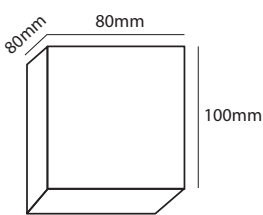
- 1 White
 2 Titan
 3 Black
 4 Chrome
 5 matt Alum.
 6 Gold
 7 matt Gold
 8 Bronze
 9 Anodized

		 OSRAM: HALOPIN PHILIPS: CLICKLINE	SPOT MINI BEAM Two way - narrow / wide beam (WALL LIGHTING)
PRICE LIST			
CODE	DESCRIPTION	COLOUR	
85706	G908 1x40W QT 14 / G9	White, Titan	
85706	G908 1x40W QT 14 / G9	Chrome, matt Alum., Gold	

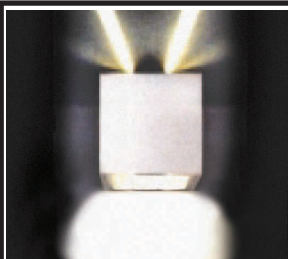
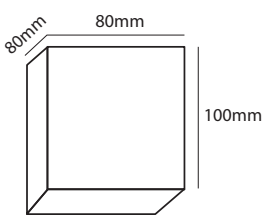
		 OSRAM: HALOPIN PHILIPS: CLICKLINE	SPOT MINI BEAM Four way - narrow beam (WALL LIGHTING)
PRICE LIST			
CODE	DESCRIPTION	COLOUR	
85707	G911 1x40W QT 14 / G9	White, Titan	
85707	G911 1x40W QT 14 / G9	Chrome, matt Alum., Gold	

		 OSRAM: HALOPIN PHILIPS: CLICKLINE	SPOT MINI BEAM Three way - 2 narrow / 1 wide beam (WALL LIGHTING)
PRICE LIST			
CODE	DESCRIPTION	COLOUR	
85708	G912 1x40W QT 14 / G9	White, Titan	
85708	G912 1x40W QT 14 / G9	Chrome, matt Alum., Gold	

Colour Codes:

- 1 White
 2 Titan
 3 Black
 4 Chrome
 5 matt Alum.
 6 Gold
 7 matt Gold
 8 Bronze
 9 Anodized



DESCRIPTION		PRICE LIST	
		CODE	PRICE
230V/12V 50W - Conventional	TRANSFORMER 12V	800001	
230V/12V 70W - Electronic	TRANSFORMER 12V	800006	
230V/12V 105W - Conventional	TRANSFORMER 12V	800002	
230V/12V 105W - Electronic	TRANSFORMER 12V	800007	