

OSRAM: T5
PHILIPS: TL5

OSRAM: HALOSPOT 111
PHILIPS: ALULINE 111

- Housing in aluminium painted electrostatically in titan or black colour.
- Parabolic reflector from high purity specular aluminium.

VOLARIS Louvre with spots
(PENDANT LUMINAIRES)

IP 20 CE F

				PRICE LIST	
CODE	DESCRIPTION	DIMENSIONS	COLOUR	Electronic ballast	
82540	VOLARIS LOUVRE 2x39W T16+2x 50W QR111	233x1300x50	Titan, Black		
82542	VOLARIS LOUVRE 2x54W T16+2x 50W QR111	233x1600x50	Titan, Black		
82545	VOLARIS LOUVRE 2X80W T16+2x 50W QR111	233x1900x50	Titan, Black		

OSRAM: T5
PHILIPS: TL5

OSRAM: T8
PHILIPS: TL-D

Parabolic **louvre 2MG** from anodized non iridescent **specular** aluminium.

3F CANDA 2MG
(SURFACE MOUNTED AND PENDANT LUMINAIRES)

CE F IP 20

				PRICE LIST			
DESCRIPTION		COLOUR		Conventional ballast and capacitor		Electronic ballast	
				CODE	PRICE	CODE	PRICE
3F CANDA 1x28W T16 2MG	166021	White				821113	
3F CANDA 1x35W T16 2MG	166023	White				821114	
3F CANDA 2x28W T16 2MG	166027	White				821109	
3F CANDA 2x35W T16 2MG	166029	White				821112	
3F CANDA 1x36W T26 2MG	160786	White		821115			
3F CANDA 1x58W T26 2MG	160787	White		821116			
3F CANDA 2x36W T26 2MG	160789	White		821101			
3F CANDA 2x58W T26 2MG	160790	White		821102			

OSRAM: T5
PHILIPS: TL5

OSRAM: T8
PHILIPS: TL-D

Parabolic **louvre 2S** from anodized non iridescent **semi-glossy** aluminium

3F CANDA 2S
(SURFACE MOUNTED AND PENDANT LUMINAIRES)

CE F IP 20

				PRICE LIST			
DESCRIPTION		COLOUR		Conventional ballast and capacitor		Electronic ballast	
				CODE	PRICE	CODE	PRICE
3F CANDA 1x28W T16 2S	165661	White				821210	
3F CANDA 1x35W T16 2S	165663	White				821211	
3F CANDA 2x28W T16 2S	165667	White				821212	
3F CANDA 2x35W T16 2S	165669	White				821213	
3F CANDA 1x36W T26 2S	160426	White		821214			
3F CANDA 1x58W T26 2S	160427	White		821215			
3F CANDA 2x36W T26 2S	160429	White		821201			
3F CANDA 2x58W T26 2S	160430	White		821216			

Colour Codes:

- 1 White 2 Titan 3 Black 4 Chrome 5 matt Alum. 6 Gold 7 matt Gold 8 Bronze 9 Anodized



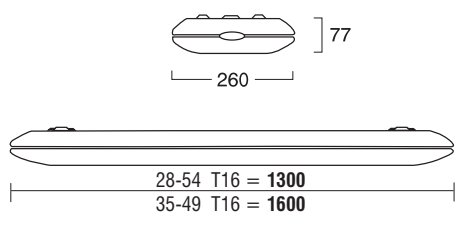





OSRAM: T5
PHILIPS: TL5

3F CANDA SP
(SURFACE MOUNTED AND PENDANT LUMINAIRES)



Sp diffuser in transparent prismatic anti-glare methacrylate.
Specular flow recuperator.

CODE			DESCRIPTION			COLOUR			PRICE LIST			
									Electronic ballast			
821308	3F CANDA 1x28W T16 SP	166141				White						
821309	3F CANDA 1x35W T16 SP	166143				White						
821310	3F CANDA 2x28W T16 SP	166147				White						
821307	3F CANDA 2x35W T16 SP	166149				White						



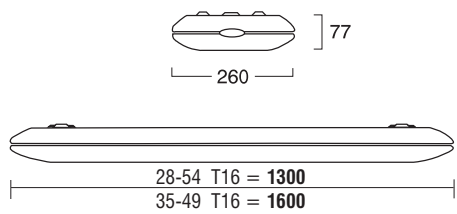





OSRAM: T5
PHILIPS: TL5

3F CANDA WW
(SURFACE MOUNTED AND PENDANT LUMINAIRES)



Wall washer parabolic flow recuperator in semi-glossy aluminium

CODE			DESCRIPTION			COLOUR			PRICE LIST			
									Electronic ballast			
821401	3F CANDA WW 1x54W T16	168052	Wall Washer			White						
821402	3F CANDA WW 1x49W T16	168054	Wall Washer			White						



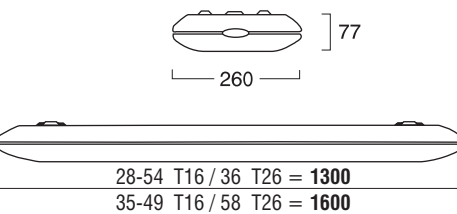



OSRAM: T5
PHILIPS: TL5



OSRAM: T8
PHILIPS: TL-D

3F CANDA DI 2MG
(PENDANT LUMINAIRES)



Parabolic **louvre 2MG** from anodized non iridescent **specular** aluminium.

DESCRIPTION			COLOUR			Conventional ballast and capacitor		Electronic ballast	
						CODE	PRICE	CODE	PRICE
3F CANDA DI 1x28W T16 2MG	167321	Direct - Indirect	White					821701	
3F CANDA DI 1x35W T16 2MG	167323	Direct - Indirect	White					821702	
3F CANDA DI 2x28W T16 2MG	167327	Direct - Indirect	White					821703	
3F CANDA DI 2x35W T16 2MG	167329	Direct - Indirect	White					821704	
3F CANDA DI 1x36W T26 2MG	162086	Direct - Indirect	White			821705			
3F CANDA DI 1x58W T26 2MG	162087	Direct - Indirect	White			821706			
3F CANDA DI 2x36W T26 2MG	162089	Direct - Indirect	White			821707			
3F CANDA DI 2x58W T26 2MG	162090	Direct - Indirect	White			821708			

OSRAM: T5
PHILIPS: TL5

 OSRAM: T8
PHILIPS: TL-D

 Parabolic **louvre 2S** from anodized non iridescent **semi-glossy** aluminium

3F CANDA DI 2S
(PENDANT LUMINAIRES)

DESCRIPTION				COLOUR	Conventional ballast and capacitor		Electronic ballast	
					CODE	PRICE	CODE	PRICE
3F CANDA DI 1x28W T16 2S	166961	Direct - Indirect	White			821801		
3F CANDA DI 1x35W T16 2S	166963	Direct - Indirect	White			821802		
3F CANDA DI 2x28W T16 2S	166967	Direct - Indirect	White			821803		
3F CANDA DI 2x35W T16 2S	166969	Direct - Indirect	White			821804		
3F CANDA DI 1x36W T26 2S	161726	Direct - Indirect	White	821805				
3F CANDA DI 1x58W T26 2S	161727	Direct - Indirect	White	821806				
3F CANDA DI 2x36W T26 2S	161729	Direct - Indirect	White	821807				
3F CANDA DI 2x58W T26 2S	161730	Direct - Indirect	White	821808				

OSRAM: T5
PHILIPS: TL5

 Asymmetric **louvre 2MG wall washer** from anodized non iridescent specular aluminium

3F CANDA DI 2MG AS WW
(PENDANT LUMINAIRES)



CODE	DESCRIPTION	COLOUR	Electronic ballast
821601	3F CANDA DI 1x28W T16 2MG AS WW 169011	White	
821602	3F CANDA DI 1x35W T16 2MG AS WW 169013	White	



OSRAM: T5
PHILIPS: TL5

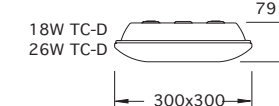
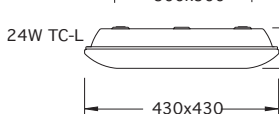

Sp diffuser, lower in transparent prismatic anti-glare methacrylate. Upper diffuser in transparent methacrylate. Specular flow **recuperator**.

3F CANDA DI SP
(PENDANT LUMINAIRES)

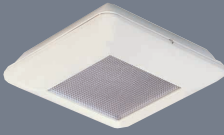
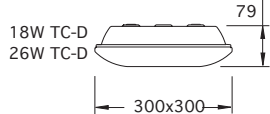
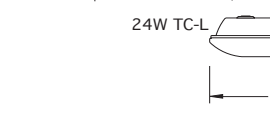
CODE	DESCRIPTION	COLOUR	Electronic ballast
821901	3F CANDA DI 1x28W T16 SP 167441 Direct - Indirect	White	
821902	3F CANDA DI 1x35W T16 SP 167443 Direct - Indirect	White	
821903	3F CANDA DI 2x28W T16 SP 167447 Direct - Indirect	White	
821904	3F CANDA DI 2x35W T16 SP 167449 Direct - Indirect	White	

		 	<p>TC-D OSRAM: DULUX D PHILIPS: PL-C</p> <p>TC-L OSRAM: DULUX L PHILIPS: PL-L</p> <p>Parabolic louvre 2MG from anodized non iridescent specular aluminium.</p>	<p>3F CANDA Quadrato 2MG (SURFACE MOUNTED LUMINAIRES)</p> 	
CODE			DESCRIPTION	COLOUR	PRICE LIST
					Conventional ballast and capacitor
821121	3F CANDA 1x18W 2MG TC-D / G24d-2	164251		White	
821105	3F CANDA 1x26W 2MG TC-D / G24d-3	164252		White	
821106	3F CANDA 2x18W 2MG TC-D / G24d-2	164254		White	
821107	3F CANDA 2x26W 2MG TC-D / G24d-3	164255		White	
821108	3F CANDA 2x24W 2MG TC-L / 2G11	164256		White	

		 	<p>TC-D OSRAM: DULUX D PHILIPS: PL-C</p> <p>TC-L OSRAM: DULUX L PHILIPS: PL-L</p> <p>Sp diffuser in transparent prismatic anti-glare methacrylate. Specular flow recuperator.</p>	<p>3F CANDA Quadrato SP (SURFACE MOUNTED LUMINAIRES)</p> 	
CODE			DESCRIPTION	COLOUR	PRICE LIST
					Conventional ballast and capacitor
821301	3F CANDA 1x18W SP TC-D / G24d-2	164291		White	
821302	3F CANDA 1x26W SP TC-D / G24d-3	164292		White	
821315	3F CANDA 2x18W SP TC-D / G24d-2	164294		White	
821316	3F CANDA 2x26W SP TC-D / G24d-3	164295		White	
821317	3F CANDA 2x24W SP TC-L / 2G11	164296		White	

			<p>Bracket, for semi-recessed installation of 3F Canda Quadrato for false ceilings with panels 600x600, 600x1200 with exposed structure or plaster board, in hot galvanized steel. Required 1 piece per luminaire.</p>	<p>3F CANDA Quadrato ACCESSORY</p>	
CODE			DESCRIPTION	COLOUR	PRICE LIST
802113	Bracket	0645			

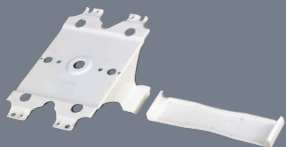
<p>A</p> 		<p>Connecting element to form channels and branches, in white painted steel with upper holes for suspensions point E or wall bracket points I. It allows the passage of the power supply line. Polycarbonate cover. It spaces the luminaires of 40mm.</p>	<p>3F CANDA ACCESSORIES</p>		
CODE			DESCRIPTION	COLOUR	PRICE LIST
802101	Connecting element	0601		white	

<p>B</p> 		<p>Linear connecting element between luminaires or between luminaires and wall, to form channels and suspended or ceiling-mounted branches, in steel with accessorizable cover, white. It allows the passage of the power supply line. Elements of desired length on request.</p>	<p>3F CANDA ACCESSORIES</p>		
CODE			DESCRIPTION	COLOUR	PRICE LIST
Linear connecting element between luminaires					
802102	Length	200mm	0602		
802114		500mm	0603		
802115		1100mm	0604		
Linear connecting element between luminaires and wall					
802116	Length	600mm	0605		
802117		1100mm	0606		

C



Connecting element
for variable interdistances between luminaires or between luminaire and wall, composed of a pair of adapter cylinders and aluminium tube 1.5m long Ø20mm, which can be sectioned to any desired length, it allows the passage of the power supply line.

3F CANDA ACCESSORIES

			PRICE LIST
CODE	DESCRIPTION	COLOUR	
802120	Pair of cylinders for luminaire 0607		
802121	Tube, white colour 0608		
802122	Boss for wall 0609		

D



Fixed suspension
with polycarbonate case, white colour, internal bracket in galvanized steel, stainless steel cables Ø1,25 mm leaded at the end for coupling on the luminaire (not on connecting element).

3F CANDA ACCESSORIES

			PRICE LIST
CODE	DESCRIPTION	COLOUR	
Unwired			
802103	Length 300mm 0610		
802104	500mm 0611		
802119	800mm 0612		
802105	1000mm 0613		
Wired with type H05VV-F 4x1,5mm²			
802106	Length 300mm 0614		
802107	500mm 0615		
802118	800mm 0616		
802108	1000mm 0617		

E



Adjustable suspension
with polycarbonate case in white colour, internal bracket in galvanized steel cables Ø1,25 mm, 1m long leaded at one end and adjusters for coupling on the luminaire and on connecting element point A. For suspensions longer than 1m, it is necessary not only to order codes 0618-0619 but also stainless steel cables Ø1,25 mm.

3F CANDA ACCESSORIES

			PRICE LIST
CODE	DESCRIPTION	COLOUR	
802109	Unwired 0618		
802110	Wired with type H05VV-F 4x1,5mm ² 0619		
802123	Reel of cable 100m length 0620		
802124	Clamps n° 100 pcs 0622		

F

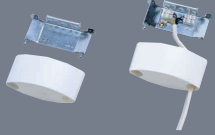

Spacers
for reflected light luminaires, space 3F Canda linear luminaires of 60 mm from the ceiling. Realized in polycarbonate, white colour, with bracket in galvanized steel, white power-supply cable type H05VV-F 4x1.5 mm². To be fixed directly on the luminaire at 600 mm centre distance. Installation also possible on false ceilings with exposed profile. Two spacers each luminaire are always necessary, even for channel installations.

3F CANDA ACCESSORIES

			PRICE LIST
CODE	DESCRIPTION	COLOUR	
802111	Pair of Spacers 0623		

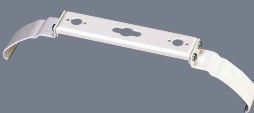
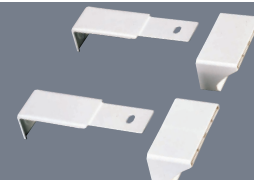
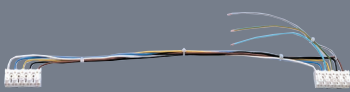
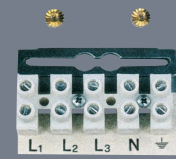
			3F CANDA ACCESSORIES
Boss with Rose 86mm for power-supply connection, in white polycarbonate, white linear power-supply cable type H05VV-F 4x1.5 mm ² , length 2 m.			
			PRICE LIST
CODE	DESCRIPTION	COLOUR	
603410	Boss with Rose 0130		
			3F CANDA ACCESSORIES
Bracket sliding on the housing, in white painted steel, for free positioning of mounting at the ceiling or suspended. Necessary suspensions D or E.			
			PRICE LIST
CODE	DESCRIPTION	COLOUR	
802112	Bracket sliding on the housing 0629		
			3F CANDA ACCESSORIES
Pair of wall-mounting elements, in white painted steel and white polycarbonate cover, spaces the luminaires of 28 mm from the wall. Mounting on the housing side and on the connecting element A in channel solutions.			
			PRICE LIST
CODE	DESCRIPTION	COLOUR	
802128	Pair of elements 0631		
			3F CANDA ACCESSORIES
5-pole cascade connection line, stiff cable H07V2-U, HT 90 °C, 1.5 mm ² , terminal blocks with connection capacity 2x2.5 mm ² .			
			PRICE LIST
CODE	DESCRIPTION	COLOUR	
	for luminaire length		
802125	1300mm 0634		
802126	1600mm 0635		
			3F CANDA ACCESSORIES
5-pole terminal block, connection capacity from 2.5 to 6 mm ² , on galvanized steel bracket for cascade connection lines.			
			PRICE LIST
CODE	DESCRIPTION	COLOUR	
802127	5-pole terminal block 0636		