

**T8400**

T800 is a recessed compact spot with rotation. It can satisfy multiple lighting requirements thanks to its wide variety of modules, and it highlights impressively premises, such as shopping malls, stores, hotels, exhibition halls, museums etc.

A LED version is also available and it is guaranteed by the use of last generation light sources, which ensure excellent performance with maximum energy efficiency. This, in combination with an efficient thermal management, makes T800 a warranty for premium lighting with LED technology.

**Technical Features**

- Aluminium recessing frame, painted electrostatically in selected colour.
- Outer adjustable ring from die-cast aluminium.
- Inner ring for easy lamp replacement.
- High pure aluminium reflectors in Spot, Medium, Wide versions.
- Tempered protection glass.
- Easy mounting with clips.

**Upon request:**

Available with highest colour rendering index (CRI)

**For LED Version**

- Pure light without IR/UV radiation.
- Die cast aluminum heatsink anodized.
- Efficient thermal management.
- 1800 lumen in 22W neutral edition or 2830 lumen in 30W.
- Operation life: 50,000 hours with efficiency > 70% of the initial luminous flux.
- Connection for operation with Constant Current.

T8400

T8400 1x... Fitting

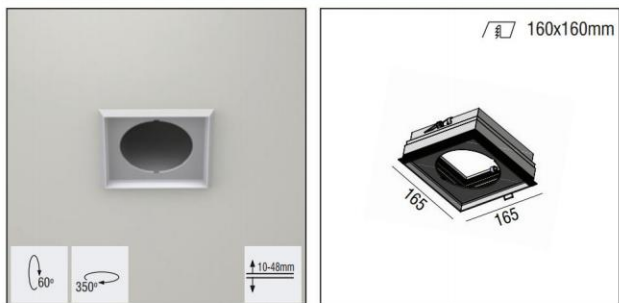

Code	Description	Kg
86268	T8400 1x...	0,500

T8410 2x... Fitting



Code	Description	Kg
86269	T8410 2x...	0,770

T8420 3x... Fitting

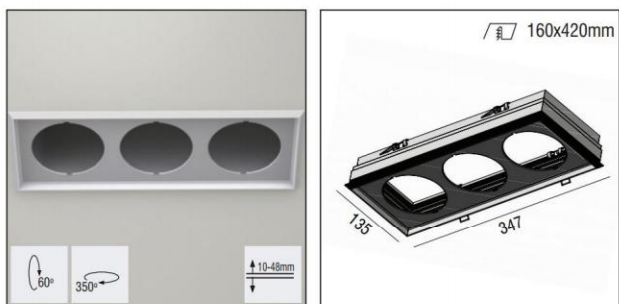

Code	Description	Kg
86270	T8420 3x...	1,020

EXAMPLE

 T8410 2x...		 MODULE 40 THETIS HIT-TC-CE/GU6,5		 BALLAST 20W ELECTRONIC	
<b>CODE</b>	<b>PIECE</b>	<b>CODE</b>	<b>PIECE</b>	<b>CODE</b>	<b>PIECE</b>
86269	1	80601	2	498113	2

T8400+ Module 40 THETIS HIT-TC-CE

Module 40 THETIS HIT-TC-CE















- Version for HIT-TC-CE/GU6,5.
- Reflector: Spot, Medium, Wide.
- Tempered protection glass.

Code	Description	Kg
80601	MODULE 40 THETIS HIT-TC-CE/GU6,5 SPOT	0,250
80646	MODULE 40 THETIS HIT-TC-CE/GU6,5 MEDIUM	0,250
80647	MODULE 40 THETIS HIT-TC-CE/GU6,5 WIDE	0,250



T8400

T8410+ Module 40 HERCULES LED REFLECTOR

Module 40 HERCULES LED REFLECTOR



CE F 850°C IP 20

60° 350°

LED

ta 25°C

350/500mA

- Reflectors: Spot, Medium, Wide.
- 7W power consumption driven at 350mA.
- 10,5W power consumption driven at 500mA.
- Efficiency:
- 7W: 4000 K: 810 Lumen, CRI: min. 80, 116 Lm/W
- 7W: 3000 K: 720 Lumen, CRI: min. 80, 103 Lm/W
- 10,5W: 4000 K: 1140 Lumen, CRI: min. 80, 109 Lm/W
- 10,5W: 3000 K: 1000 Lumen, CRI: min. 80, 95 Lm/W

Code	Description	Kg
80603	MODULE 40 HERCULES LED REFLECTOR 7/10,5W	0,350



T8420+ Module 40 IASON LED REFLECTOR HO

Module 40 IASON LED REFLECTOR HO

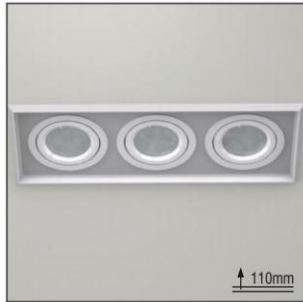

CE F 850°C IP 20

60° 350°

LED

ta 25°C

350/500mA

- Reflectors: Spot, Medium, Wide.
- 7W power consumption driven at 350mA.
- 10,5W power consumption driven at 500mA.
- Efficiency:
- 7W: 4000 K: 810 Lumen, CRI: min. 80, 116 Lm/W
- 7W: 3000 K: 720 Lumen, CRI: min. 80, 103 Lm/W
- 10,5W: 4000 K: 1140 Lumen, CRI: min. 80, 109 Lm/W
- 10,5W: 3000 K: 1000 Lumen, CRI: min. 80, 95 Lm/W

Code	Description	Kg
80604	MODULE 40 IASON LED REFLECTOR HO 7/10,5W	0,350



LED COLOUR CODES:

2 Warm 3 Neutral

BEAM CODES:

01 spot 02 medium 03 wide

Colour Codes:

0 Colours 1 White 2 Titan 3 Black 4 Chrome 5 matt Alum.

DRIVERS

LED LUMINAIRES DESCRIPTION	N° Modules		DIMENSIONS mm	CODE
	min.	max.		
MODULE 40 THETIS GU6,5	20W	1 1	20W Electronic	498113
MODULE 40 THETIS GU6,5	35W	1 1	35W Electronic	498223
MODULE 40 HERCULES/IASON LED	1x 7W	1 1	350mA 8W IP20 70 x 35 x 21	800020
MODULE 40 HERCULES/IASON LED	2x 7W	1 2	350mA 15W IP20 160 x 22 x 19	800021
MODULE 40 HERCULES/IASON LED	3x 7W	1 3	350mA 25W IP20 123 x 80 x 22	800041
MODULE 40 HERCULES/IASON LED	1x 10,5W	1 1	500mA 12W IP20 120 x 35 x 19	800023
MODULE 40 HERCULES/IASON LED	2x 10,5W	1 2	500mA 30W IP20 160 x 50 x 22	800030
MODULE 40 HERCULES/IASON LED	3x 10,5W	1 3	500mA 32W IP20 123 x 80 x 22	800041

DIMMER DRIVERS

LED LUMINAIRES DESCRIPTION	N° Modules		DIMMER TYPE	DIMENSIONS mm	CODE
	min.	max.			
MODULE 40 HERCULES/IASON	1x, 2x 7W	1 2	350mA 15W IP20 1-10Vdc/Push Button	145 x 40 x 28	800040
MODULE 40 HERCULES/IASON	3x 7W	1 3	350mA 25W IP20 1-10Vdc/Push Button*	123 x 80 x 22	800043
MODULE 40 HERCULES/IASON	3x 7W	1 3	350mA 25W IP20 1-10Vdc/Push Button/Dali*	123 x 80 x 22	800042
MODULE 40 HERCULES/IASON	1x, 2x 10,5W	1 2	500mA 22W IP20 1-10Vdc/Push Button	145 x 40 x 28	800040
MODULE 40 HERCULES/IASON	3x 10,5W	1 3	500mA 32W IP20 1-10Vdc/Push Button*	123 x 80 x 22	800043
MODULE 40 HERCULES/IASON	3x 10,5W	1 3	500mA 32W IP20 1-10Vdc/Push Button/Dali*	123 x 80 x 22	800042

\* Please order synchronization cable for each dimmer driver separately - Code: 800044 (4m)

T8400

