

■ TRITON	PAGE	20
■ CLUB		24
■ ERMIS		38
■ IRIS		40
■ CREA 1		42
■ CREA 2		46



TRITON



TRITON is a compact luminaire with minimal design. It's cutting-edge LED technology ensures excellent colour quality and high efficiency and makes TRITON suitable for highlighting several types of premises.

Technical Features

- Aluminium body, painted electrostatically in selected colour.
- High efficiency reflectors in Spot, Medium, Wide versions.
- With Universal adapter for mounting on 3-phase track.
- With point outlet for surface-mounted installation.
- Connection for operation on 230V-50/60Hz with electronic ballast.
- Pure light without IR/UV radiation.
- Efficient thermal management.
- 10W up to 43W wattage range and 1100 up to 4643 luminous flux range.
- Operation life: 50,000 hours with efficiency > 70% of the initial luminous flux.
- Connection for operation on 230V/50Hz.

Upon request:

Available with highest colour rendering index (CRI)

TRITON

TRITON



- Version for LED CHIP.
- Aluminium body.
- Reflector in Medium & Wide version.
- With Universal adapter for mounting on 3-phase track.
- With point outlet for surface-mounted installation.
- 10W power consumption driven at 350mA.
- 14W power consumption driven at 500mA.
- Efficiency:
 - 10W: 4000 K: 1195 Lumen, CRI: min. 80
 - 10W: 3000 K: 1100 Lumen, CRI: min. 80
 - 14W: 4000 K: 1615 Lumen, CRI: min. 80
 - 14W: 3000 K: 1490 Lumen, CRI: min. 80
 - Maximum: 129 Lm/W

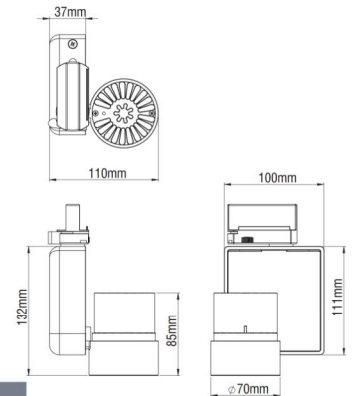

Code	Description	Kg
89180	TRITON 10W Track	1,000
89181	TRITON 10W Ceiling	1,000
89182	TRITON 14W Track	1,000
89183	TRITON 14W Ceiling	1,000

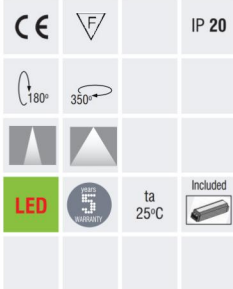

TRITON 2



- Version for LED CHIP.
- Aluminium body.
- Reflector in Spot, Medium & Wide version.
- With Universal adapter for mounting on 3-phase track.
- With point outlet for surface-mounted installation.
- 30W power consumption driven at 700mA.
- 43W power consumption driven at 1050mA.
- Efficiency:
 - 30W: 4000 K: 3290 Lumen, CRI: min. 80
 - 30W: 3000 K: 3143 Lumen, CRI: min. 80
 - 43W: 4000 K: 4643 Lumen, CRI: min. 80
 - 43W: 3000 K: 4435 Lumen, CRI: min. 80
 - Maximum: 110Lm/W

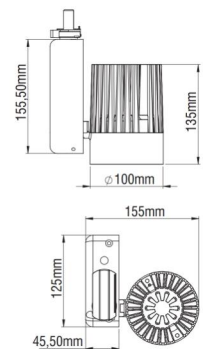

Code	Description	Kg
89184	TRITON 30W Track	2,100
89185	TRITON 30W Ceiling	2,100
89186	TRITON 43W Track	2,100
89187	TRITON 43W Ceiling	2,100



LED COLOUR CODES:

2 Warm 3 Neutral

BEAM CODES:

01 spot 02 medium 03 wide

Colour Codes:

0 Colours 1 White 2 Titan 3 Black





SPOTLIGHT

TRACK or CEILING

CLUB

The CLUB luminaires highlight impressively premises, such as shopping malls, stores, hotels, exhibition halls, museums etc. They are compact and efficient and they have excellent colour quality and high-precision light distribution.

MINI CLUB LED - CLUB 1 LED - CLUB 2 LED - Complete lighting range

The LED chip is available in two colour temperatures, warm and neutral. The luminaire is ON/OFF or dimmable and it can be mounted on track or on ceiling.

Technical Features

- Aluminium body, painted electrostatically in selected colour.
- High pure aluminium reflectors in Spot, Medium, Wide versions.
- With Universal adapter for mounting on 3-phase track.
- With point outlet for surface-mounted installation.
- Connection for operation on 230V-50/60Hz with electronic ballast.

Upon request

- Connection for operation with electronic dimmable ballast.

For LED Version

- Pure light without IR/UV radiation.
- Efficient thermal management.
- 7W up to 43W wattage range and 485 up to 4643 luminous flux range.
- Operation life: 50,000 hours with efficiency > 70% of the initial luminous flux.
- Connection for operation on 230V/50Hz.

Upon request:

Available with highest colour rendering index (CRI)

CLUB

CLUB 60 - GU10



- Version for PAR16/GU10.
- Aluminium body.
- With Universal adapter for mounting on 3-phase track.
- With point outlet for surface-mounted installation.

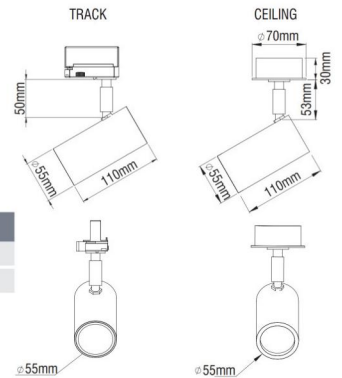

Code	Description	Kg
89240	CLUB 60 Track 1x max. 50W / GU10	0,300
89250	CLUB 60 Ceiling 1x max. 50W / GU10	0,350

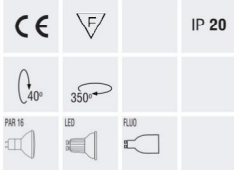

CLUB 60 S - GU10

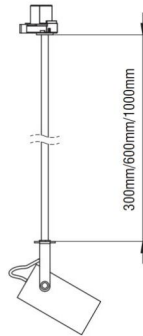
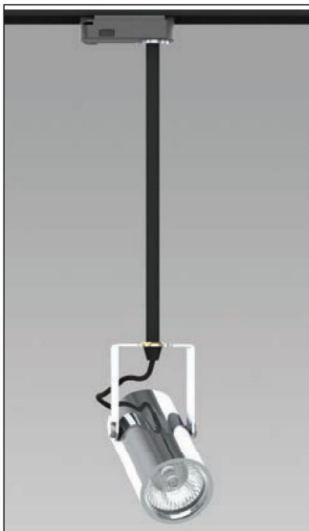

- Version for PAR16/GU10.
- Aluminium body.
- With Universal adapter for mounting on 3-phase track.
- With point outlet for surface-mounted installation.

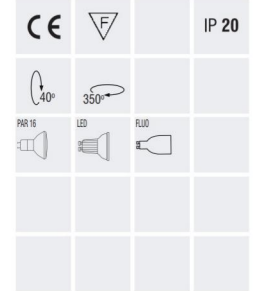

Code	Description	Kg
89241	CLUB 60 S Track 1x max. 50W / GU10 30cm	0,400
89251	CLUB 60 S Ceiling 1x max. 50W / GU10 30cm	0,450
89242	CLUB 60 S Track 1x max. 50W / GU10 60cm	0,430
89252	CLUB 60 S Ceiling 1x max. 50W / GU10 60cm	0,480
89243	CLUB 60 S Track 1x max. 50W / GU10 100cm	0,460
89253	CLUB 60 S Ceiling 1x max. 50W / GU10 100cm	0,510

CLUB MINI - LED CHIP



- Version for LED CHIP.
- Aluminium body.
- Lens in Spot, Medium, Wide versions.
- Reflector in Medium version.
- With Universal adapter for mounting on 3-phase track.
- With point outlet for surface-mounted installation.
- 7W power consumption driven at 500mA.
- Efficiency:
7W: 4000 K: 510 Lumen, CRI: min. 80
7W: 3000 K: 485 Lumen, CRI: min. 80
Maximum: 102 Lm/W

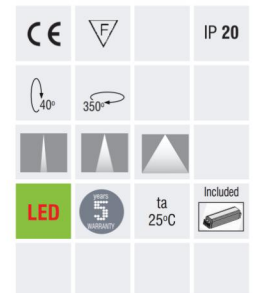

Code	Description	Kg
89210	CLUB MINI 7W Track	0,500
89220	CLUB MINI 7W Ceiling	0,550
89211	CLUB MINI 7W Reflector Track	0,500
89221	CLUB MINI 7W Reflector Ceiling	0,550

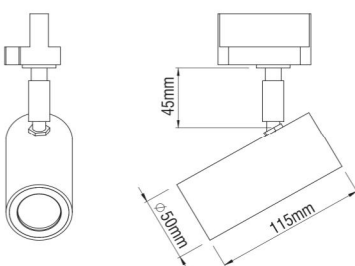

CLUB

CLUB 1 - LED



- Version for LED CHIP.
- Aluminium body.
- High pure aluminium reflectors in Spot, Medium, Wide versions.
- With Universal adapter for mounting on 3-phase track.
- With point outlet for surface-mounted installation.
- Efficiency:
 - 22W: 4000 K: 2440 Lumen, CRI: min. 80
 - 22W: 3000 K: 2331 Lumen, CRI: min. 80
 - 30W: 4000 K: 3290 Lumen, CRI: min. 80
 - 30W: 3000 K: 3143 Lumen, CRI: min. 80
- Maximum: 111 Lm/W

Code	Description	Kg
89330	CLUB1 22W Track	1,250
89340	CLUB1 22W Ceiling	1,300
89331	CLUB1 30W Track	1,250
89341	CLUB1 30W Ceiling	1,300

CE	F	IP 20
170°	350°	
LED	ta 25°C	Included

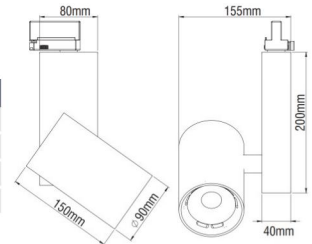

CLUB 1 LEVEL - LED



- Version for LED CHIP.
- Aluminium body.
- High pure aluminium reflectors in Spot, Medium, Wide versions.
- With Universal adapter for mounting on 3-phase track.
- With point outlet for surface-mounted installation.
- Efficiency:
 - 22W: 4000 K: 2440 Lumen, CRI: min. 80
 - 22W: 3000 K: 2331 Lumen, CRI: min. 80
 - 30W: 4000 K: 3290 Lumen, CRI: min. 80
 - 30W: 3000 K: 3143 Lumen, CRI: min. 80
- Maximum: 111 Lm/W

Code	Description	Kg
89680	CLUB1 LEVEL 22W Track	1,250
89690	CLUB1 LEVEL 22W Ceiling	1,300
89681	CLUB1 LEVEL 30W Track	1,250
89691	CLUB1 LEVEL 30W Ceiling	1,300

CE	F	IP 20
170°	350°	
LED	ta 25°C	Included

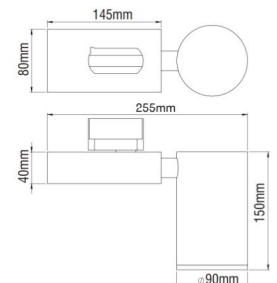

CLUB 1 - LED SUN



- Version for LED CHIP.
- Aluminium body.
- High efficiency LED lens.
- With Universal adapter for mounting on 3-phase track.
- With point outlet for surface-mounted installation.
- Efficiency:
 - 22W: 4000 K: 2440 Lumen, CRI: min. 80
 - 22W: 3000 K: 2331 Lumen, CRI: min. 80
 - 30W: 4000 K: 3290 Lumen, CRI: min. 80
 - 30W: 3000 K: 3143 Lumen, CRI: min. 80
- Maximum: 111 Lm/W

Code	Description	Kg
89332	CLUB1 Sun 22W Track	1,250
89342	CLUB1 Sun 22W Ceiling	1,300
89333	CLUB1 Sun 30W Track	1,250
89343	CLUB1 Sun 30W Ceiling	1,300

CE	F	IP 20
170°	350°	
LED	ta 25°C	Included

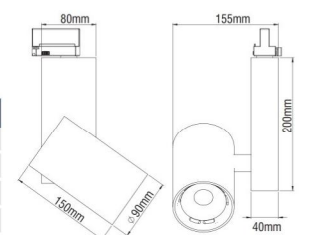

SPOTLIGHT

CLUB

CLUB 1 LEVEL - LED SUN



- Version for LED CHIP.
- Aluminium body.
- High efficiency LED lens.
- With Universal adapter for mounting on 3-phase track.
- With point outlet for surface-mounted installation.
- Efficiency: 22W: 4000 K: 2440 Lumen, CRI: min. 80
22W: 3000 K: 2331 Lumen, CRI: min. 80
30W: 4000 K: 3290 Lumen, CRI: min. 80
30W: 3000 K: 3143 Lumen, CRI: min. 80
- Maximum: 111 Lm/W

Code	Description	Kg
89700	CLUB1 LEVEL Sun 22W Track	1,250
89760	CLUB1 LEVEL Sun 22W Ceiling	1,300
89701	CLUB1 LEVEL Sun 30W Track	1,250
89761	CLUB1 LEVEL Sun 30W Ceiling	1,300

CLUB 1 SHORT - LED



- Version for LED CHIP.
- Aluminium body.
- High pure aluminium reflectors in Spot, Medium, Wide versions.
- With Universal adapter for mounting on 3-phase track.
- With point outlet for surface-mounted installation.
- Efficiency: 10W: 4000 K: 950 Lumen, CRI: min. 80
10W: 3000 K: 900 Lumen, CRI: min. 80
15W: 4000 K: 1425 Lumen, CRI: min. 80
15W: 3000 K: 1350 Lumen, CRI: min. 80
20W: 4000 K: 1900 Lumen, CRI: min. 80
20W: 3000 K: 1800 Lumen, CRI: min. 80
- Maximum: 95 Lm/W

Code	Description	Kg
89960	CLUB1 SHORT 10W/230V Track	1,000
89961	CLUB1 SHORT 10W/230V Ceiling	1,000
89970	CLUB1 SHORT 15W/230V Track	1,000
89971	CLUB1 SHORT 15W/230V Ceiling	1,000
89980	CLUB1 SHORT 20W/230V Track	1,000
89981	CLUB1 SHORT 20W/230V Ceiling	1,000



CLUB 1 - ACCESSORIES

HONEYCOMB LOUVRE Ø90

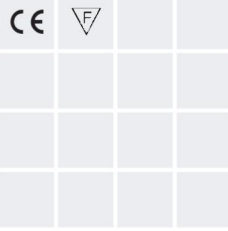

- Aluminium external ring.
- Honeycomb louvre.

Code	Description
80913	Honeycomb Louvre Ø90

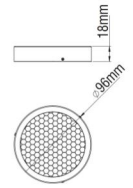

OVAL OUTLINE LENS Ø90

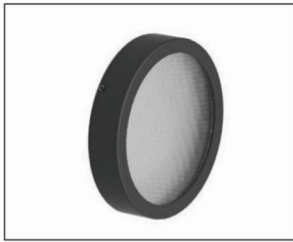

- Aluminium external ring.
- Glass oval outline lens.

Code	Description
80912	Oval Outline lens Ø90

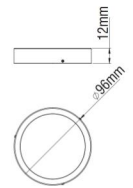

SOFT OUTLINE LENS Ø90

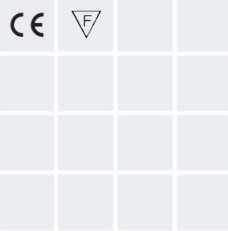

- Aluminium external ring.
- Glass soft outline lens.

Code	Description
80911	Soft Outline Lens Ø90

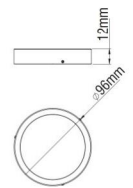

ANTI-GLARE BLADES Ø90

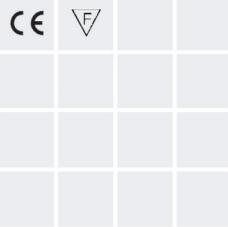

- Aluminium external ring.
- Anti-glare blades.

Code	Description
80914	Anti-glare Blades Ø90

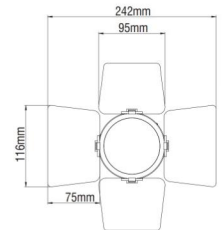

SPOTLIGHT

TRACK or CEILING

CLUB

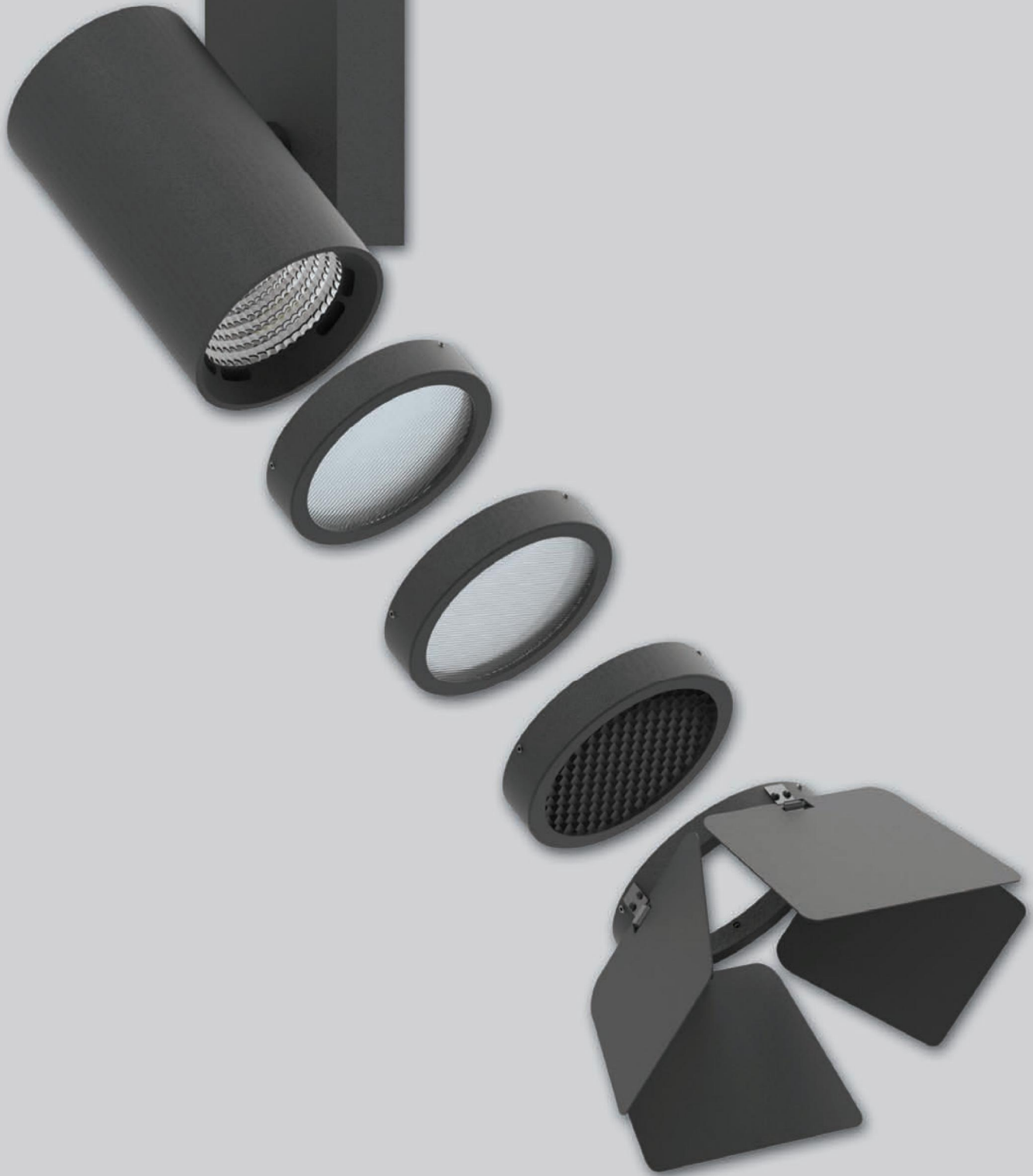





CLUB

CLUB 2 - HIT-CE / HIT-TC-CE



- Version for QR111/G53, HI-PAR111/GX8,5, LED R111/GU10.
- Aluminium body.
- With Universal adapter for mounting on 3-phase track.

Code	Description	Kg
89367	CLUB2 35W HI-PAR 111 / GX8,5	1,500
89368	CLUB2 70W HI-PAR 111 / GX8,5	1,500
89360	CLUB2 LED R111 / GU10	1,500
89369	CLUB2 QR111/G53 max. 60W	1,500

CE	F	IP 20
170°	350°	
		Included
LED		

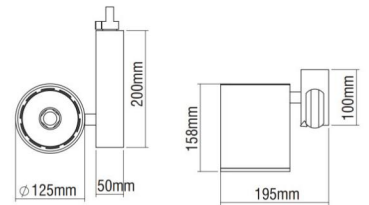

CLUB 2 LEVEL - HIT-CE / HIT-TC-CE



- Version for QR111/G53, HI-PAR111/GX8,5, LED R111/GU10.
- Aluminium body.
- With Universal adapter for mounting on 3-phase track.

Code	Description	Kg
89817	CLUB2 LEVEL 35W HI-PAR 111 / GX8,5	1,500
89818	CLUB2 LEVEL 70W HI-PAR 111 / GX8,5	1,500
89810	CLUB2 LEVEL LED R111 / GU10	1,500
89819	CLUB2 LEVEL QR111/G53 max. 60W	1,500

CE	F	IP 20
90°	350°	
		Included
LED		

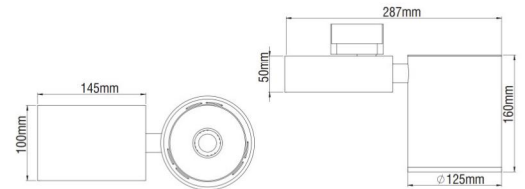

CLUB 2 SHORT - QR111



- Version for QR111/G53, LED R111/GU10.
- Aluminium body.
- With Universal adapter for mounting on 3-phase track.

Code	Description	Kg
89840	CLUB2 SHORT LED R111 / GU10	1,200
89849	CLUB2 SHORT QR111/G53 max. 60W	1,200

CE	F	IP 20
180°	350°	
		Included
LED		

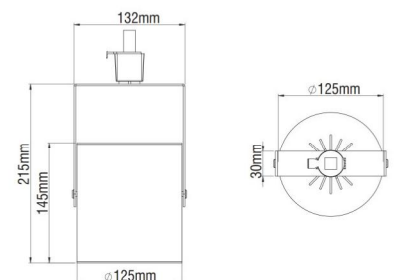

CLUB

CLUB 2 - LED



- Version for LED CHIP.
- Aluminium body.
- High pure aluminium reflectors in Spot, Medium, Wide versions.
- Passive cooling.
- With Universal adapter for mounting on 3-phase track.
- 43W power consumption driven at 1050mA.
- Efficiency:
 - 43W: 4000 K: 4643 Lumen, CRI: min. 80
 - 43W: 3000 K: 4435 Lumen, CRI: min. 80
 - Maximum: 108Lm/W



Code	Description	Kg
89350	CLUB2 43W Track	1,300

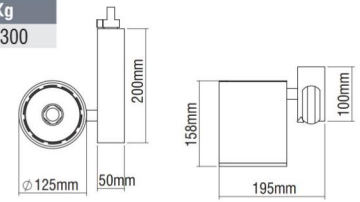

CLUB 2 LEVEL - LED



- Version for LED CHIP.
- Aluminium body.
- High pure aluminium reflectors in Spot, Medium, Wide versions.
- Passive cooling.
- With Universal adapter for mounting on 3-phase track.
- 43W power consumption driven at 1100mA.
- Efficiency:
 - 43W: 4000 K: 4643 Lumen, CRI: min. 80
 - 43W: 3000 K: 4435 Lumen, CRI: min. 80
 - Maximum: 108Lm/W

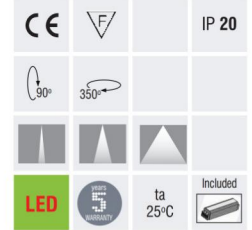

Code	Description	Kg
89890	CLUB2 LEVEL 43W Track	1,300

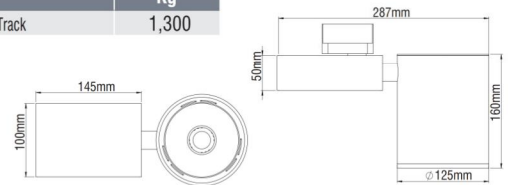

CLUB 2 SHORT - LED



- Version for LED CHIP.
- Aluminium body.
- High pure aluminium reflectors in Spot, Medium, Wide versions.
- Passive cooling.
- With Universal adapter for mounting on 3-phase track.
- Efficiency:
 - 25W: 4000 K: 2000 Lumen, CRI: min. 80
 - 25W: 3000 K: 2000 Lumen, CRI: min. 80
 - Maximum: 80Lm/W

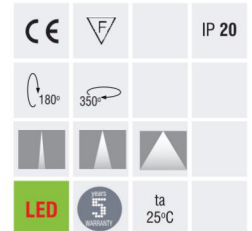

Code	Description	Kg
89856	CLUB2 SHORT 25W/230V Track	1,300

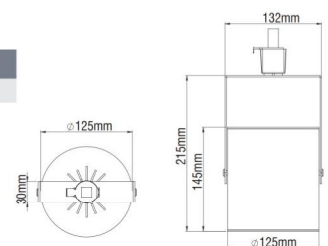

LED COLOUR CODES:

2 Warm 3 Neutral

BEAM CODES:

01 spot 02 medium 03 wide

Colour Codes:

0 Colours 1 White 2 Titan 3 Black 4 Chrome 5 matt Alum.

CLUB 2 - ACCESSORIES

HONEYCOMB LOUVRE Ø125



CE	▽		

- Aluminium external ring.
- Honeycomb louvre.

Code	Description
80923	Honeycomb Louvre Ø125

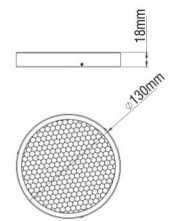

OVAL OUTLINE LENS Ø125



CE	▽		

- Aluminium external ring.
- Glass oval outline lens.

Code	Description
80922	Oval Outline lens Ø125

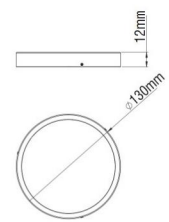

SOFT OUTLINE LENS Ø125



CE	▽		

- Aluminium external ring.
- Glass soft outline lens.

Code	Description
80921	Soft Outline Lens Ø125

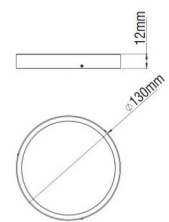

ANTI-GLARE BLADES Ø125



CE	▽		

- Aluminium external ring.
- Anti-glare blades.

Code	Description
80924	Anti-glare Blades Ø125

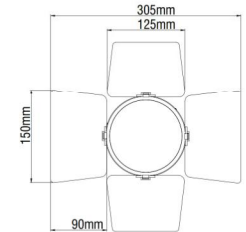

SPOTLIGHT

TRACK or CEILING

CLUB

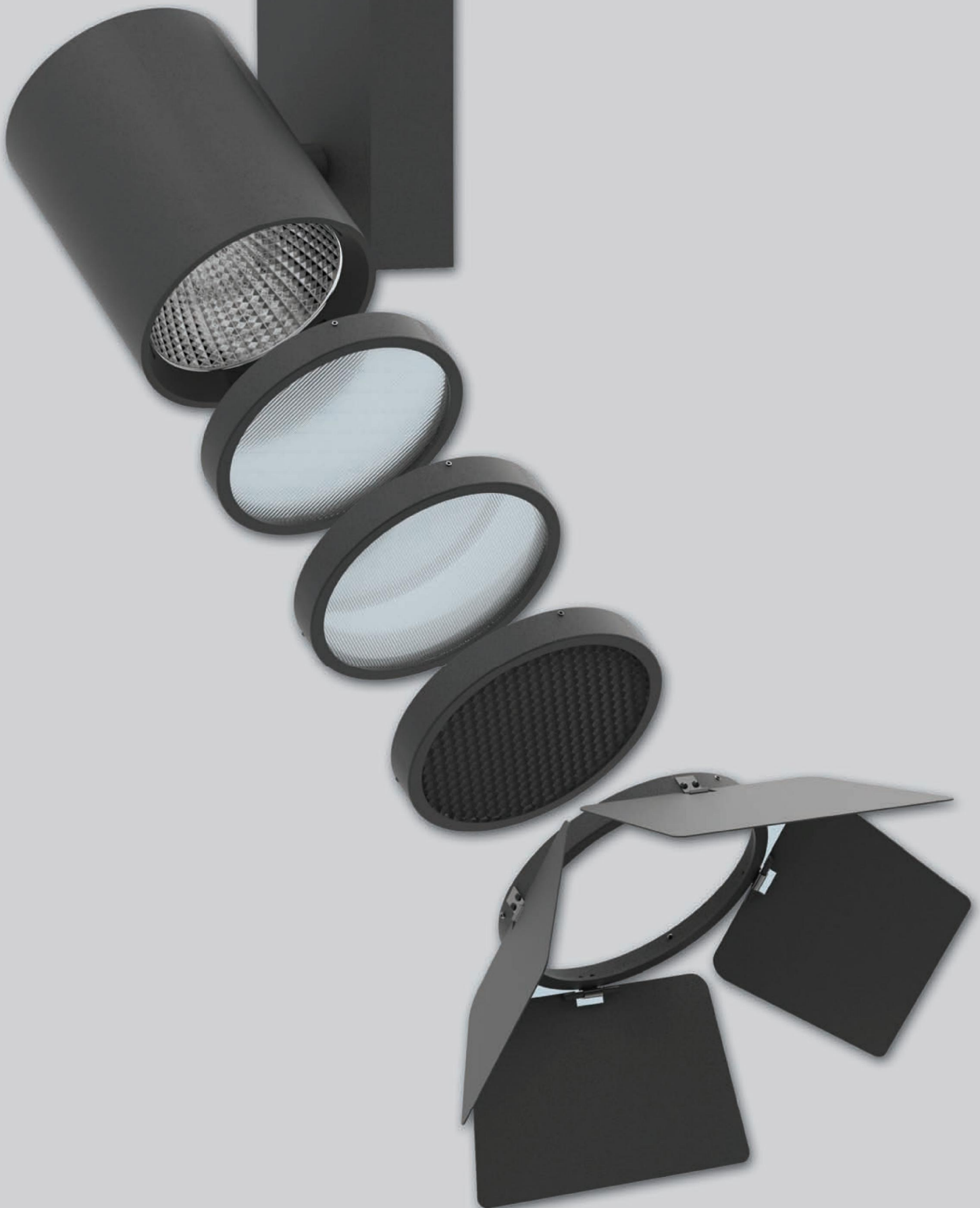





SPOTLIGHT

TRACK or CEILING

ERMIS



*Ermis is a delicate luminaire with QR111 lamp.
It is ideal for premises, such as shopping malls, hotels,
exhibition halls, museums, cafe, restaurants etc.
It can be mounted on track or on ceiling.*

Technical Features

- Aluminium body, painted electrostatically in selected colour.
- With Universal adapter for mounting on 3-phase track or with point outlet for surface-mounted installation.
- Connection for operation on 230V-50/60Hz with electronic transformer.

ERMIS

ERMIS - QR111

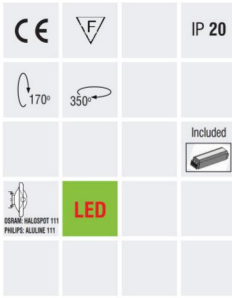

- Version for QR111/G53 and LED R111/G53.
- Aluminium body.
- With Universal adapter for mounting on 3-phase track.
- With point outlet for surface-mounted installation.

Code	Description	Kg
89399	ERMIS QR111/G53 max. 60W Track	0,650
89409	ERMIS LED R111/G53 12W Track	0,650
89479	ERMIS QR111/G53 max. 60W Ceiling	0,650
89489	ERMIS LED R111/G53 12W Ceiling	0,650

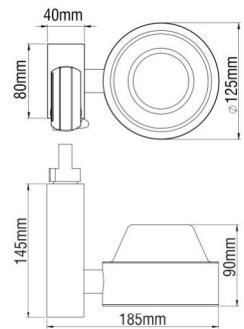

Colour Codes:

0 Colours 1 White 2 Titan 3 Black 4 Chrome*

* Only for lamp body

IRIS



A track mounted luminaire with four different light sources. It highlights impressively premises, such as shopping malls, stores, hotels, exhibition halls, museums etc. It is compact and efficient and it has high-precision light distribution.

Technical Features

- Aluminium body, painted electrostatically in selected colour.
- High pure aluminium reflectors in Spot, Medium, Wide versions.
- Tempered protection glass.
- With Universal adapter for mounting on 3-phase track.
- Connection for operation on 230V-50/60Hz with electronic ballast.

Upon request

- Connection for operation with electronic dimmable ballast.

IRIS

IRIS - HIT-CE / HIT-TC-CE / QR111 / HI-PAR111 / LED R111



- Version for HIT-CE/G12, HIT-TC-CE/G8,5, QR111/G53, HI-PAR111/GX8,5, LED R111/GU10.
- Aluminium body.
- High pure aluminium reflectors in Spot, Medium, Wide versions and tempered protection glass for HIT-CE and HIT-TC-CE versions.
- With Universal adapter for mounting on 3-phase track.

Code	Description	Kg
89431	IRIS 35W HIT-CE / G12 SPOT	1,050
89441	IRIS 35W HIT-CE / G12 MEDIUM	1,050
89451	IRIS 35W HIT-CE / G12 WIDE	1,050
89432	IRIS 70W HIT-CE / G12 SPOT	1,050
89442	IRIS 70W HIT-CE / G12 MEDIUM	1,050
89452	IRIS 70W HIT-CE / G12 WIDE	1,050
89435	IRIS 35W HIT-TC-CE / G8,5 SPOT	1,050
89445	IRIS 35W HIT-TC-CE / G8,5 MEDIUM	1,050
89455	IRIS 35W HIT-TC-CE / G8,5 WIDE	1,050
89436	IRIS 70W HIT-TC-CE / G8,5 SPOT	1,050
89446	IRIS 70W HIT-TC-CE / G8,5 MEDIUM	1,050
89456	IRIS 70W HIT-TC-CE / G8,5 WIDE	1,050
89467	IRIS 35W HI-PAR 111 / GX8,5	1,000
89468	IRIS 70W HI-PAR 111 / GX8,5	1,000
89469	IRIS QR111/G53 max. 60W	1,000
89460	IRIS LED R111 / GU10	1,100

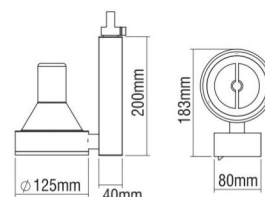

IRIS - LEVEL HIT-CE / HIT-TC-CE / QR111 / HI-PAR111 / LED R111



- Version for HIT-CE/G12, HIT-TC-CE/G8,5, QR111/G53, HI-PAR111/GX8,5, LED R111/GU10.
- Aluminium body.
- High pure aluminium reflectors in Spot, Medium, Wide versions and tempered protection glass for HIT-CE and HIT-TC-CE versions.
- With Universal adapter for mounting on 3-phase track.

Code	Description	Kg
89861	IRIS LEVEL 35W HIT-CE / G12 SPOT	1,050
89871	IRIS LEVEL 35W HIT-CE / G12 MEDIUM	1,050
89881	IRIS LEVEL 35W HIT-CE / G12 WIDE	1,050
89862	IRIS LEVEL 70W HIT-CE / G12 SPOT	1,050
89872	IRIS LEVEL 70W HIT-CE / G12 MEDIUM	1,050
89882	IRIS LEVEL 70W HIT-CE / G12 WIDE	1,050
89865	IRIS LEVEL 35W HIT-TC-CE / G8,5 SPOT	1,050
89875	IRIS LEVEL 35W HIT-TC-CE / G8,5 MEDIUM	1,050
89885	IRIS LEVEL 35W HIT-TC-CE / G8,5 WIDE	1,050
89866	IRIS LEVEL 70W HIT-TC-CE / G8,5 SPOT	1,050
89876	IRIS LEVEL 70W HIT-TC-CE / G8,5 MEDIUM	1,050
89886	IRIS LEVEL 70W HIT-TC-CE / G8,5 WIDE	1,050
89867	IRIS LEVEL 35W HI-PAR 111 / GX8,5	1,000
89868	IRIS LEVEL 70W HI-PAR 111 / GX8,5	1,000
89869	IRIS LEVEL QR111/G53 max. 60W	1,000
89860	IRIS LEVEL LED R111 / GU10	1,100

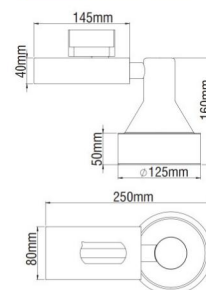

Colour Codes:

0 Colours 1 White 2 Titan 3 Black 4 Chrome

SPOTLIGHT

TRACK or CEILING

CREA 1



A track or ceiling mounted luminaire with different light sources. It highlights impressively premises, such as shopping malls, stores, hotels, exhibition halls, museums etc. It is compact and economical architectural version.

Technical Features

- Aluminium body, painted electrostatically in selected colour.
- With Universal adapter for mounting on 3-phase track.
- Connection for operation on 230V-50/60Hz with electronic ballast.

Upon request

- Connection for operation with electronic dimmable ballast.

CREA 1

CREA 1 - QR111



CE	V	IP 20
170°	350°	Included
SONNE HALOGEN 111 PHILIPS HALOGEN 111	LED	

- Version for QR111/G53 or LED R111/G53.
- Aluminium body.
- With Universal adapter for mounting on 3-phase track.

Code	Description	Kg
89509	CREA 1 TRACK 1x max.70W QR111/G53	0,700
89519	CREA 1 CEILING 1x max.70W QR111/G53	0,800
89549	CREA 1 TRACK 1x LED R111/G53	0,700
89559	CREA 1 CEILING 1x LED R111/G53	0,800

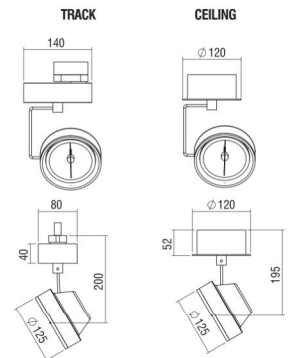

Colour Codes:

0 Colours 1 White 2 Titan 3 Black 4 Chrome*

* Only for lamp body





CREA 2

A track or ceiling mounted luminaire with specific led light 230V source. It highlights impressively premises, such as shopping malls, stores, hotels, exhibition halls, museums etc. It is compact and economical architectural version.

**Technical Features**

- Aluminium body, painted electrostatically in selected colour.
- With Universal adapter for mounting on 3-phase track.
- Connection for operation on 230V-50/60Hz.

CREA 2

CREA 2 - LED R111



CE	V	IP 20
170°	350°	
LED		

- Version for LED R111/GU10.
- Aluminium body.
- With Universal adapter for mounting on 3-phase track.

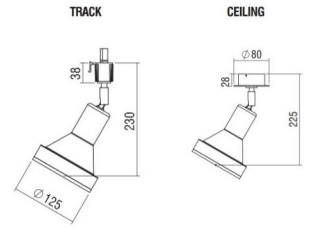

Code	Description	Kg
89560	CREA 2 TRACK 1x LED R111/GU10	0,700
89570	CREA 2 CEILING 1x LED R111/GU10	0,800

Colour Codes:

0 Colours 1 White 2 Titan 3 Black 4 Chrome*

* Only for lamp body

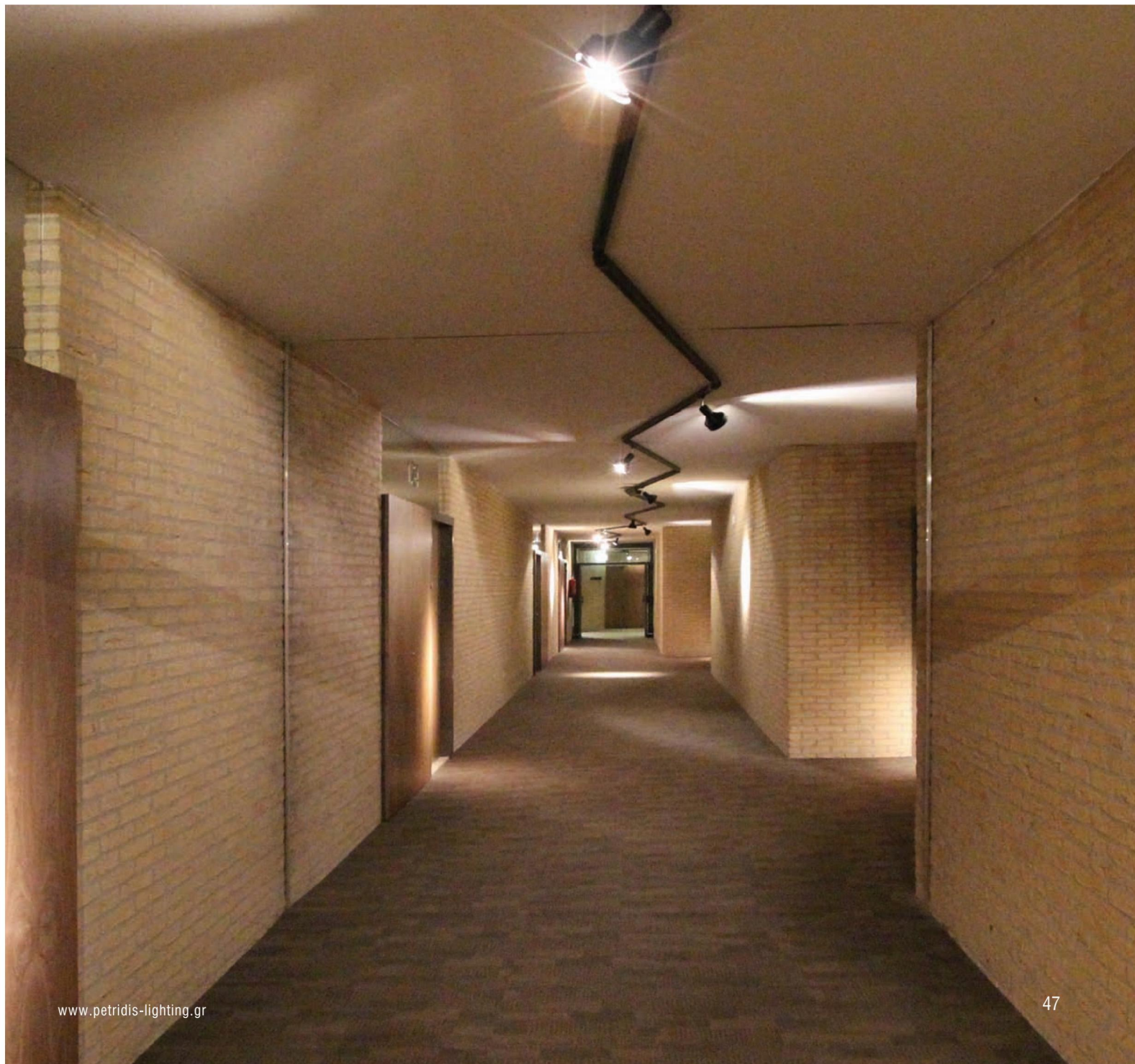

TRACKS & ACCESSORIES

3 Circuit Track (L₁ / L₂ / L₃ / neutral / earth) 16A / 400V

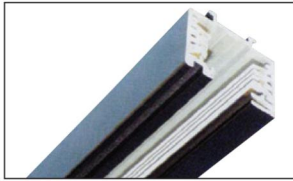

Code	Description	Colour
803011	GLOBAL XTS 4100-3	White
803013	GLOBAL XTS 4100-2	Black
803012	GLOBAL XTS 4100-1	Titan

3 Circuit Track (L₁ / L₂ / L₃ / neutral / earth) 16A / 400V recessed

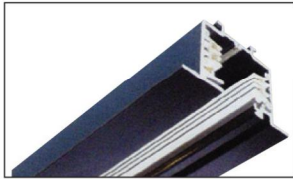

Code	Description	Colour
803021	GLOBAL XTSF 4100-3	White
803023	GLOBAL XTSF 4100-2	Black
803022	GLOBAL XTSF 4100-1	Titan

END FEED

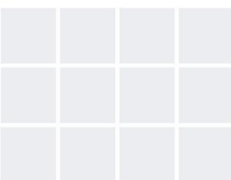
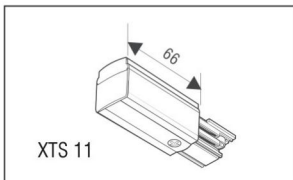

Code	Description	Colour
803041	GLOBAL XTS 11-3	White
803043	GLOBAL XTS 11-2	Black
803042	GLOBAL XTS 11-1	Titan
803191	GLOBAL XTS 12-3	White
803193	GLOBAL XTS 12-2	Black
803192	GLOBAL XTS 12-1	Titan

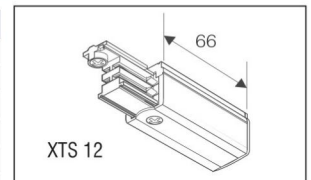

CONNECTOR

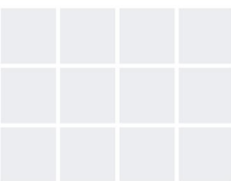
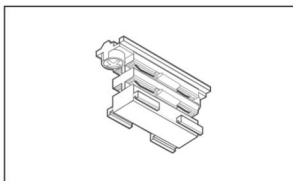

Code	Description	Colour
803051	GLOBAL XTS 21-3	White
803053	GLOBAL XTS 21-2	Black
803052	GLOBAL XTS 21-1	Titan

MIDDLE FEED

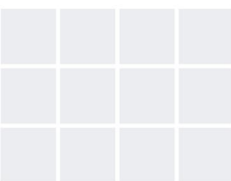
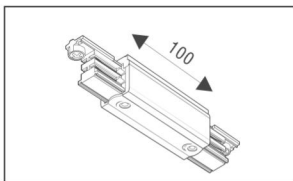

Code	Description	Colour
803061	GLOBAL XTS 14-3	White
803063	GLOBAL XTS 14-2	Black
803062	GLOBAL XTS 14-1	Titan

ANGLE CONNECTOR

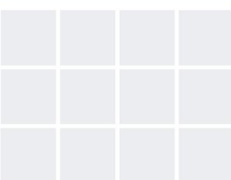
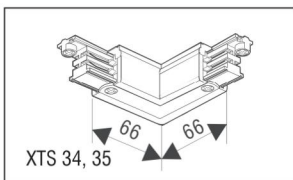

Code	Description	Colour
803071	GLOBAL XTS 34-3	White
803073	GLOBAL XTS 34-2	Black
803072	GLOBAL XTS 34-1	Titan
803201	GLOBAL XTS 35-3	White
803203	GLOBAL XTS 35-2	Black
803202	GLOBAL XTS 35-1	Titan

FLEX CONNECTOR

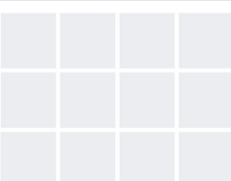
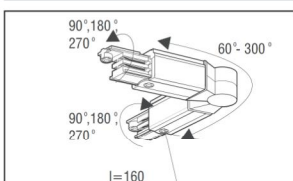

Code	Description	Colour
803081	GLOBAL XTS 24-3	White
803083	GLOBAL XTS 24-2	Black
803082	GLOBAL XTS 24-1	Titan

TRACKS & ACCESSORIES

FLEX CONNECTOR

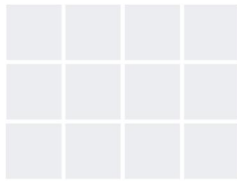
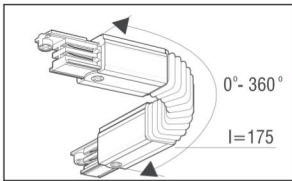

Code	Description	Colour
803091	GLOBAL XTS 23-3	White
803093	GLOBAL XTS 23-2	Black
803092	GLOBAL XTS 23-1	Titan

T - CONNECTOR

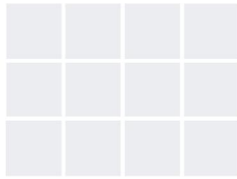
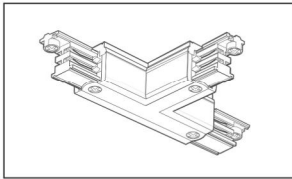

Code	Description	Colour
803211	GLOBAL XTS 36-3	White
803213	GLOBAL XTS 36-2	Black
803212	GLOBAL XTS 36-1	Titan
803101	GLOBAL XTS 37-3	White
803103	GLOBAL XTS 37-2	Black
803102	GLOBAL XTS 37-1	Titan
803221	GLOBAL XTS 39-3	White
803223	GLOBAL XTS 39-2	Black
803222	GLOBAL XTS 39-1	Titan
803111	GLOBAL XTS 40-3	White
803113	GLOBAL XTS 40-2	Black
803112	GLOBAL XTS 40-1	Titan

X - CONNECTOR

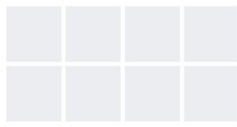
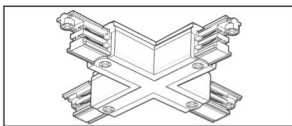

Code	Description	Colour
803121	GLOBAL XTS 38-3	White
803123	GLOBAL XTS 38-2	Black
803122	GLOBAL XTS 38-1	Titan

END PLATE

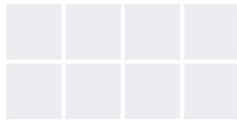
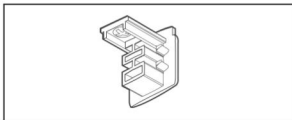

Code	Description	Colour
803031	GLOBAL XTS 41-3	White
803033	GLOBAL XTS 41-2	Black
803032	GLOBAL XTS 41-1	Titan

FIXING COMPONENTS

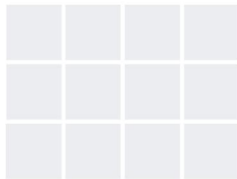
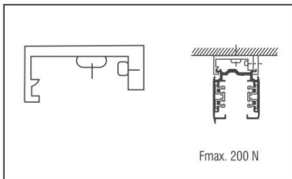

Code	Description	Colour
803131	GLOBAL SKB 12-3	White
803133	GLOBAL SKB 12-2	Black
803132	GLOBAL SKB 12-1	Titan

CORD SUSPENSION

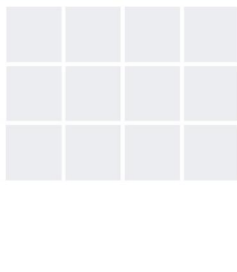
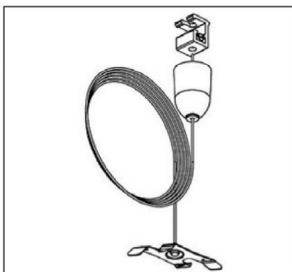

Code	Description	Length	Colour
803292	GLOBAL SPW 11SK-1/1,5	1,5m	Titan
803293	GLOBAL SPW 11SK-2/1,5	1,5m	Black
803291	GLOBAL SPW 11SK-3/1,5	1,5m	White
803302	GLOBAL SPW 11SK-1/3,0	3,0m	Titan
803303	GLOBAL SPW 11SK-2/3,0	3,0m	Black
803301	GLOBAL SPW 11SK-3/3,0	3,0m	White
803312	GLOBAL SPW 11SK-1/5,0	5,0m	Titan
803313	GLOBAL SPW 11SK-2/5,0	5,0m	Black
803311	GLOBAL SPW 11SK-3/5,0	5,0m	White

POWER SUPPLY ADAPTER

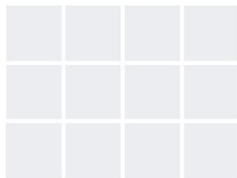
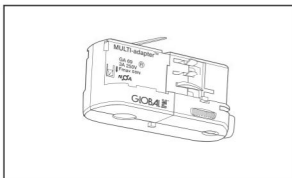

Code	Description	Colour
803181	GLOBAL GA 69-3	White
803183	GLOBAL GA 69-2	Black
803182	GLOBAL GA 69-1	Titan

TRACKS & ACCESSORIES

1 Circuit Track (L₁ / neutral / earth) 16A / 230V

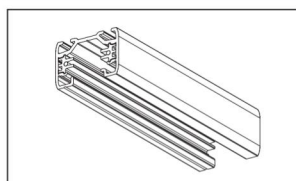

CE			IP 20

Code	Description	Colour
803231	GB 2100-3	White
803233	GB 2100-2	Black
803232	GB 2100-1	Titan

1 Circuit Track (L₁ / neutral / earth) 16A / 230V recessed

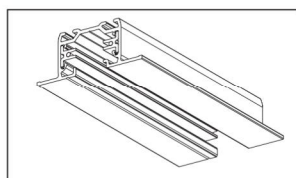

CE			IP 20

Code	Description	Colour
803351	GBF 2100-3	White
803353	GBF 2100-2	Black
803352	GBF 2100-1	Titan

END FEED

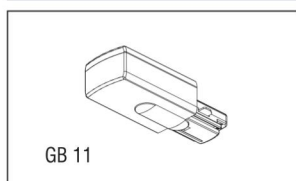

CE			

Code	Description	Colour
803261	GB 11-3	White
803263	GB 11-2	Black
803262	GB 11-1	Titan
803361	GB 12-3	White
803363	GB 12-2	Black
803362	GB 12-1	Titan

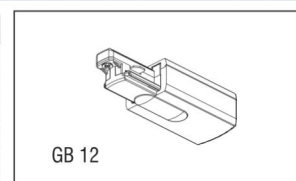

MIDDLE FEED

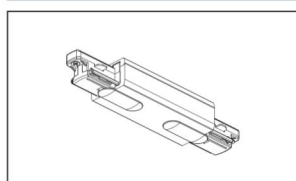

Code	Description	Colour
803371	GB 14-3	White
803373	GB 14-2	Black
803372	GB 14-1	Titan

CONNECTOR

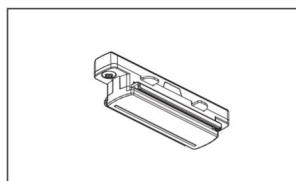

Code	Description	Colour
803241	GB 21-3	White
803243	GB 21-2	Black
803242	GB 21-1	Titan

ANGLE CONNECTOR

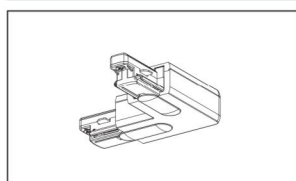

Code	Description	Colour
803381	GB 34-3	White
803383	GB 34-2	Black
803382	GB 34-1	Titan
803391	GB 35-3	White
803393	GB 35-2	Black
803392	GB 35-1	Titan

TRACKS & ACCESSORIES

T - CONNECTOR

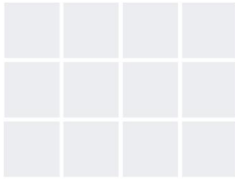
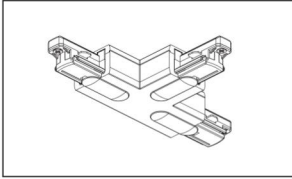

Code	Description	Colour
803401	GB 36-3	White
803403	GB 36-2	Black
803402	GB 36-1	Titan
803411	GB 37-3	White
803413	GB 37-2	Black
803412	GB 37-1	Titan
803421	GB 39-3	White
803423	GB 39-2	Black
803422	GB 39-1	Titan
803431	GB 40-3	White
803433	GB 40-2	Black
803432	GB 40-1	Titan

X - CONNECTOR

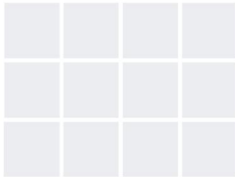
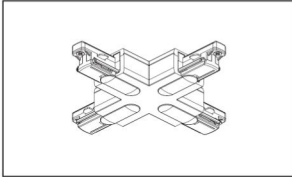

Code	Description	Colour
803441	GB 38-3	White
803443	GB 38-2	Black
803442	GB 38-1	Titan

END CAP

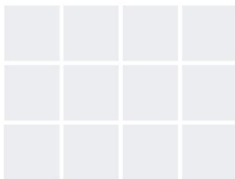
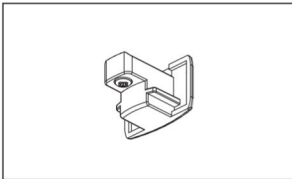

Code	Description	Colour
803251	GB 41-3	White
803253	GB 41-2	Black
803252	GB 41-1	Titan

SPOTLIGHT

TRACKS & ACCESSORIES

Track (L₁ / L₂ / L₃ / neutral / ground) 16A / 400V + DA / DA 2x1A / 50V FELV AC (DALI)

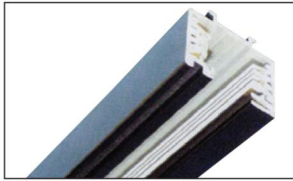

CE			IP 20

Code	Description	Colour
803321	XTSC 6100-3	White
803323	XTSC 6100-2	Black
803322	XTSC 6100-1	Titan

Track (L₁ / L₂ / L₃ / neutral / ground) 16A / 400V + DA / DA 2x1A / 50V FELV AC (DALI) recessed

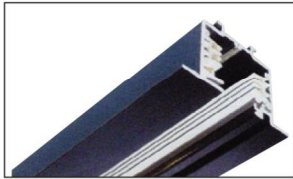

CE			IP 20

Code	Description	Colour
803451	XTSCF 6100-3	White
803453	XTSCF 6100-2	Black
803452	XTSCF 6100-1	Titan

END FEED

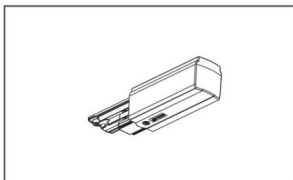

CE			IP 20

Code	Description	Colour
803331	XTSC 611-3	White
803333	XTSC 611-2	Black
803332	XTSC 611-1	Titan
803461	XTSC 612-3	White
803463	XTSC 612-2	Black
803462	XTSC 612-1	Titan

MIDDLE FEED

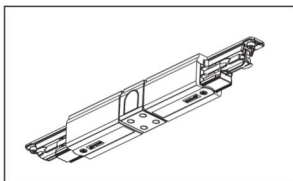

Code	Description	Colour
803471	XTSC 614-3	White
803473	XTSC 614-2	Black
803472	XTSC 614-1	Titan

CONNECTOR

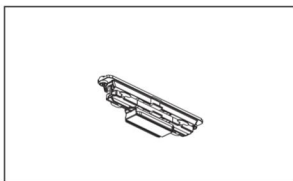

Code	Description	Colour
803341	XTS 621-3	White
803343	XTS 621-2	Black
803342	XTS 621-1	Titan

FLEX CONNECTOR

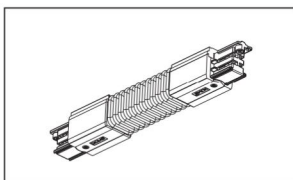

Code	Description	Colour
803481	XTSC 623-3	White
803483	XTSC 623-2	Black
803482	XTSC 623-1	Titan

ANGLE - CONNECTOR

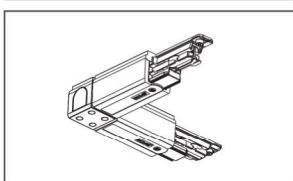

Code	Description	Colour
803491	XTSC 634-3	White
803493	XTSC 634-2	Black
803492	XTSC 634-1	Titan
803501	XTSC 635-3	White
803502	XTSC 635-2	Black
803503	XTSC 635-1	Titan

SPOTLIGHT

TRACKS & ACCESSORIES

T - CONNECTOR

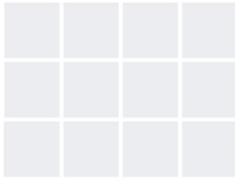
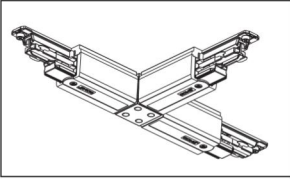

Code	Description	Colour
803511	XTSC 636-3	White
803513	XTSC 636-2	Black
803512	XTSC 636-1	Titan
803521	XTSC 637-3	White
803523	XTSC 637-2	Black
803522	XTSC 637-1	Titan
803531	XTSC 639-3	White
803533	XTSC 639-2	Black
803532	XTSC 639-1	Titan
803541	XTSC 640-3	White
803543	XTSC 640-2	Black
803542	XTSC 640-1	Titan

X - CONNECTOR

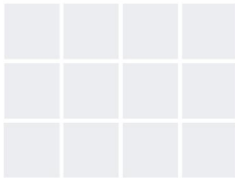
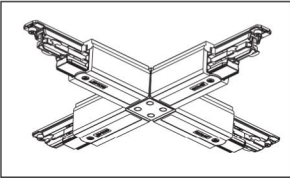

Code	Description	Colour
803551	XTSC 638-3	White
803553	XTSC 638-2	Black
803552	XTSC 638-1	Titan

END CAP

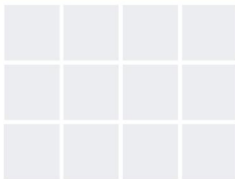
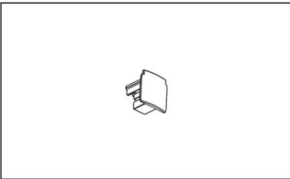

Code	Description	Colour
803031	XTS 41-3	White
803033	XTS 41-2	Black
803032	XTS 41-1	Titan

Use of L- and T-accessories
Red line indicates polarity ridge



Floor view

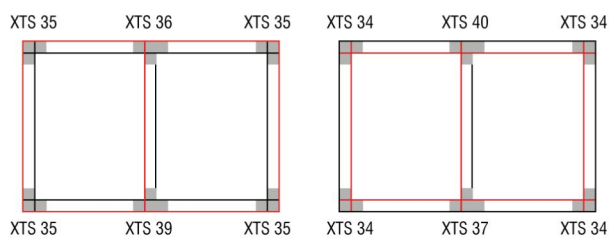



QUAP
AQUAPANE
AQUAPANE

UNMATCHED