

	PAGE
■ IKAROS (SURFACE MOUNTED and PENDANT) .....	398
■ HIGH SYSTEM / LOW SYSTEM (SURFACE MOUNTED and PENDANT) .....	404
■ SLOTLIGHT (SURFACE MOUNTED and PENDANT) .....	420
■ STREAMLIGHT (SURFACE MOUNTED and PENDANT) .....	442
■ OMICRON (PENDANT) .....	450
■ HIGH SYSTEM / LOW SYSTEM (RECESSED) .....	454
■ SLOTLIGHT (RECESSED) .....	462
■ STREAMLIGHT (RECESSED) .....	476
■ HIGH SYSTEM FRAME (RECESSED) .....	488
■ SLOTLIGHT FRAME (RECESSED) .....	492
■ STREAMLIGHT FRAME (RECESSED) .....	498
■ HIGH SYSTEM TRIMLESS (RECESSED) .....	508
■ HIGH SYSTEM SURFACE - TRIMLESS (RECESSED) .....	511
■ SLOTLIGHT TRIMLESS (RECESSED) .....	512
■ STREAMLIGHT TRIMLESS (RECESSED) .....	518

## IKAROS

---

*Ikaros is a cutting-edge continuous-row LED system that combines efficiency with a compact uninterrupted design. The three available optics (Wide, Wallwasher and Double-asymmetric) make it versatile and suitable for premises where diffuse lighting or vertical-surfaces illumination is requested (super markets, retail shops, storage corridors etc).*



### Technical Features

---

- Continuous led line system.
- Trunking from aluminium profile, painted electrostatically in selected colour.
- Gear tray from aluminium profile.
- Driver included.
- Led modules in high efficient or high output operation.
- High efficient PMMA optics in three different versions.
- Pre-wired gear trays for easy and fast installation.
- Pure light without IR/UV radiation.
- Efficient thermal management.
- Up to 63W/m and 8190 Lm luminous flux range.
- Operation life: 50,000 hours with efficiency > 70% of the initial luminous flux.
- Connection for operation on 230V/50Hz.

### Upon request

- Connection for operation with electronic dimmable ballast and emergency function.

IKAROS

TRUNKING

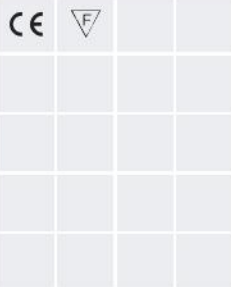
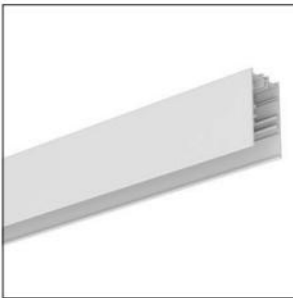

- Aluminium profile.
- Suspension and power supply not included.

Code	Description	L	Kg
968200	Ikaros Trunking Special / m	1000	1,250
968201	Ikaros Trunking White / m	1000	1,250
968202	Ikaros Trunking Titan / m	1000	1,250
968203	Ikaros Trunking Black / m	1000	1,250

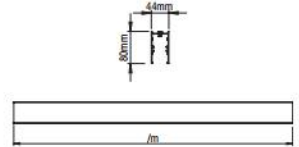

GEAR TRAY



- Version for LED CHIP.
- Aluminium body.
- High efficient optics in PMMA.
- 3 Types of available optics: Standard / 90°, double asymmetric / 2AS, asymmetric / WW.
- Efficiency: 151 Lumen / Watt max.

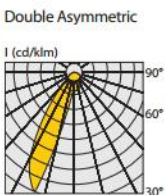
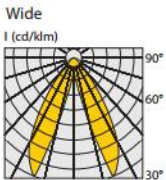
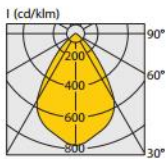
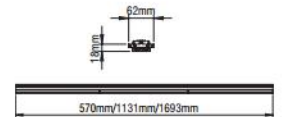

Asymmetric

High Efficiency Gear Tray			
Code	Description	L	Kg
968101	Ikaros Gear Tray 10W Neutral Wide	570	1200
968102	Ikaros Gear Tray 10W Neutral 2AS	570	1200
968103	Ikaros Gear Tray 10W Neutral WW	570	1200
968104	Ikaros Gear Tray 10W Warm Wide	570	1200
968105	Ikaros Gear Tray 10W Warm 2AS	570	1200
968106	Ikaros Gear Tray 10W Warm WW	570	1200
968107	Ikaros Gear Tray 20W Neutral Wide	1131	2200
968108	Ikaros Gear Tray 20W Neutral 2AS	1131	2200
968109	Ikaros Gear Tray 20W Neutral WW	1131	2200
968110	Ikaros Gear Tray 20W Warm Wide	1131	2200
968111	Ikaros Gear Tray 20W Warm 2AS	1131	2200
968112	Ikaros Gear Tray 20W Warm WW	1131	2200
968113	Ikaros Gear Tray 30W Neutral Wide	1693	3,200
968114	Ikaros Gear Tray 30W Neutral 2AS	1693	3,200
968115	Ikaros Gear Tray 30W Neutral WW	1693	3,200
968116	Ikaros Gear Tray 30W Warm Wide	1693	3,200
968117	Ikaros Gear Tray 30W Warm 2AS	1693	3,200
968118	Ikaros Gear Tray 30W Warm WW	1693	3,200

High Output Gear Tray			
Code	Description	L	Kg
968119	Ikaros Gear Tray 21W Neutral Wide	570	1200
968120	Ikaros Gear Tray 21W Neutral 2AS	570	1200
968121	Ikaros Gear Tray 21W Neutral WW	570	1200
968122	Ikaros Gear Tray 21W Warm Wide	570	1200
968123	Ikaros Gear Tray 21W Warm 2AS	570	1200
968124	Ikaros Gear Tray 21W Warm WW	570	1200
968125	Ikaros Gear Tray 42W Neutral Wide	1131	2200
968126	Ikaros Gear Tray 42W Neutral 2AS	1131	2200
968127	Ikaros Gear Tray 42W Neutral WW	1131	2200
968128	Ikaros Gear Tray 42W Warm Wide	1131	2200
968129	Ikaros Gear Tray 42W Warm 2AS	1131	2200
968130	Ikaros Gear Tray 42W Warm WW	1131	2200
968131	Ikaros Gear Tray 63W Neutral Wide	1693	3,200
968132	Ikaros Gear Tray 63W Neutral 2AS	1693	3,200
968133	Ikaros Gear Tray 63W Neutral WW	1693	3,200
968134	Ikaros Gear Tray 63W Warm Wide	1693	3,200
968135	Ikaros Gear Tray 63W Warm 2AS	1693	3,200
968136	Ikaros Gear Tray 63W Warm WW	1693	3,200



IKAROS ACCESSORIES

TRUNKING METAL COVER



- Aluminium profile.
- Blind metal cover.

Code	Description	L	Kg
968205	Ikaros Trunking Metal Cover Special/m	1000	0,350
968206	Ikaros Trunking Metal Cover White/m	1000	0,350
968207	Ikaros Trunking Metal Cover Titan/m	1000	0,350
968208	Ikaros Trunking Metal Cover Black/m	1000	0,350

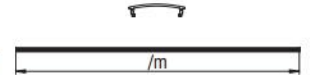

TRUNKING ANGLE 90°

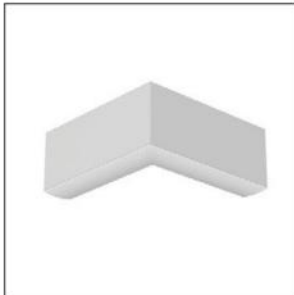

- Aluminium profile.
- Blind metal cover included.

Code	Description	L	Kg
968210	Ikaros Trunking Angle Special/m	1000	0,650
968211	Ikaros Trunking Angle White/m	1000	0,650
968212	Ikaros Trunking Angle Titan/m	1000	0,650
968213	Ikaros Trunking Angle Black/m	1000	0,650

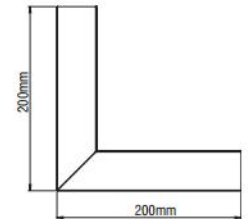

TRUNKING +3Phase Track

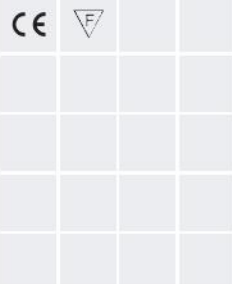
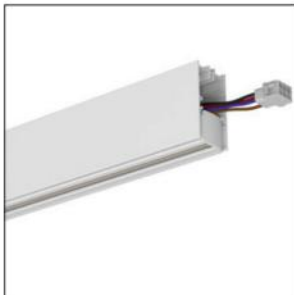

- Aluminium profile.
- 3phase track included.

Code	Description	L	Kg
968230	Ikaros Trunking+3P Track Special/m	500	0,800
968231	Ikaros Trunking+3P Track White/m	500	0,800
968232	Ikaros Trunking+3P Track Titan/m	500	0,800
968233	Ikaros Trunking+3P Track Black/m	500	0,800
968234	Ikaros Trunking+3P Track Special/m	1000	1,600
968235	Ikaros Trunking+3P Track White/m	1000	1,600
968236	Ikaros Trunking+3P Track Titan/m	1000	1,600
968237	Ikaros Trunking+3P Track Black/m	1000	1,600
968238	Ikaros Trunking+3P Track Special/m	1500	2,300
968239	Ikaros Trunking+3P Track White/m	1500	2,300
968240	Ikaros Trunking+3P Track Titan/m	1500	2,300
968241	Ikaros Trunking+3P Track Black/m	1500	2,300
968242	Ikaros Trunking+3P Track Special/m	2000	3,100
968243	Ikaros Trunking+3P Track White/m	2000	3,100
968244	Ikaros Trunking+3P Track Titan/m	2000	3,100
968245	Ikaros Trunking+3P Track Black/m	2000	3,100

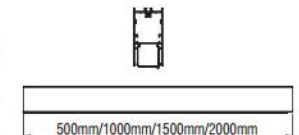

CABLE CONNECTIONS

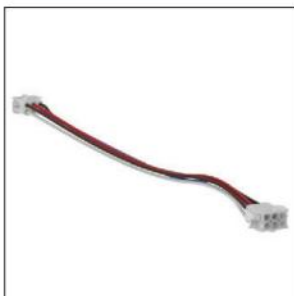

- PTFE cable connenctions.
- 5pole for standard version and 7pole for dali or emergency versions.

Code	Description	L	Kg
968250	Cable connections 5x1,5mm <sup>2</sup>	1000	0,200
968251	Cable connections 5x1,5mm <sup>2</sup>	1500	0,280
968252	Cable connections 5x1,5mm <sup>2</sup>	2000	0,380
968256	Cable connections 7x1,5mm <sup>2</sup>	1000	0,230
968257	Cable connections 7x1,5mm <sup>2</sup>	1500	0,300
968258	Cable connections 7x1,5mm <sup>2</sup>	2000	0,440

IKAROS ACCESSORIES

SINGLE ADJUSTABLE SUSPENSION

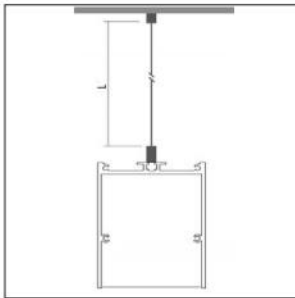

CE

- Stainless steel cable and regulators.
- **Required:**  
2 pieces for up to 3m profile.

Code	Description	L	Kg
900111	Single Suspension	500	0,050
900112	Single Suspension	1000	0,100
900113	Single Suspension	1500	0,150
900114	Single Suspension	2000	0,200
900116	Single Suspension	3000	0,300

POWER SUPPLY



CE

- For pendant use.
- Plastic body.
- With transparent cable 3x0,75mm<sup>2</sup>.
- Round version.

Code	Description	L	Kg
900121	Power Supply with Rosette Ø75	500	0,060
900122	Power Supply with Rosette Ø75	1000	0,120
900123	Power Supply with Rosette Ø75	1500	0,180
900124	Power Supply with Rosette Ø75	2000	0,240
900126	Power Supply with Rosette Ø75	3000	0,360

POWER SUPPLY



CE

- For pendant use.
- Body from aluminium profile.
- With 2m transparent cable 3x0,75mm<sup>2</sup>.
- Square or round version.

Code	Description	Kg
90042	Power Supply L 2m with Rosette Ø80	0,130
90043	Power Supply L 2m with Rosette Ø70	0,130
90044	Power Supply L 2m with Rosette 80x80	0,210
90045	Power Supply L 2m with Rosette 70x70	0,200

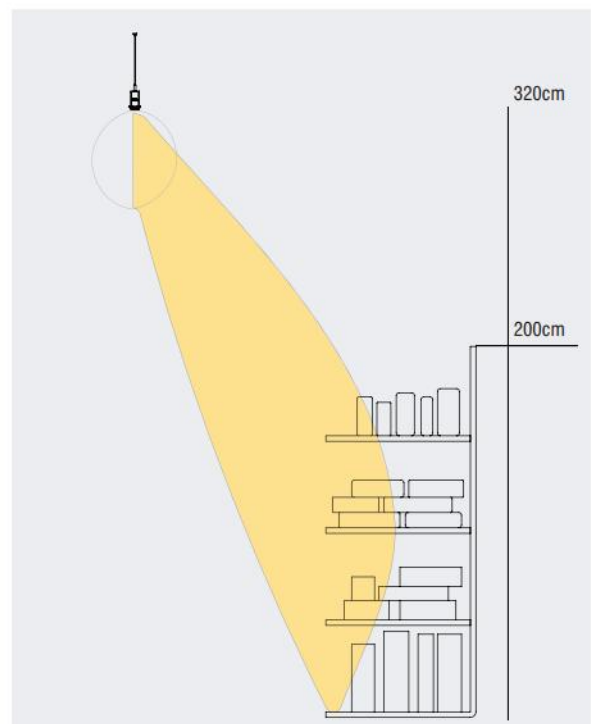
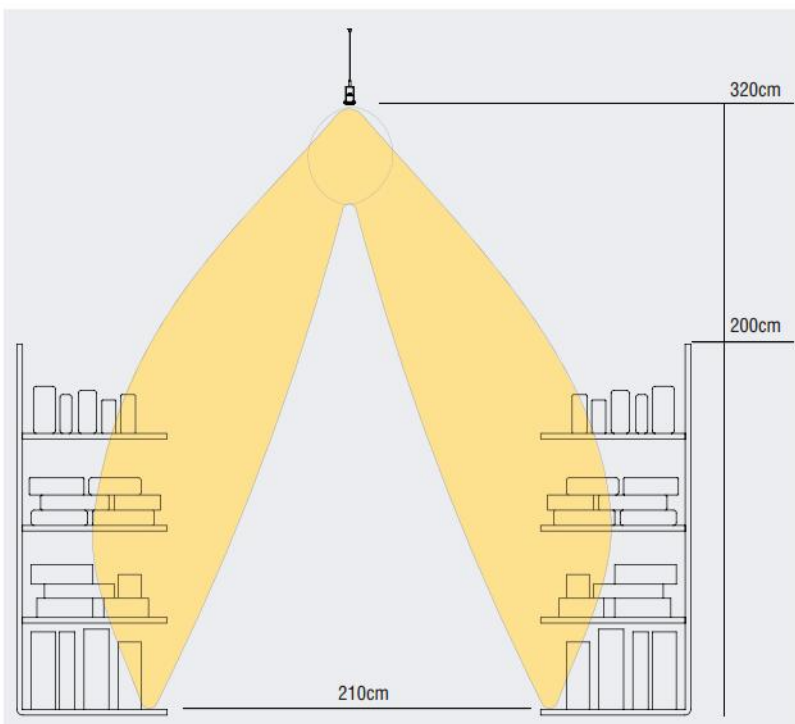

IKAROS ACCESSORIES

END CAP

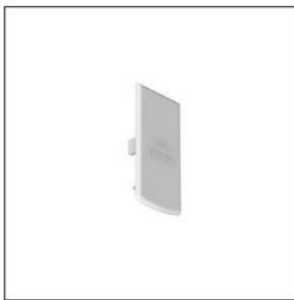

- Plastic end cap.

Code	Description	Kg
968254	Plastic End Cap pair	0,050

TRUNKING CONNECTORS

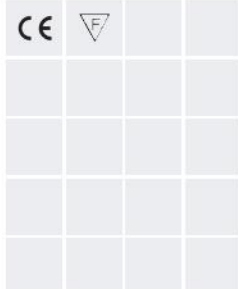

- Aluminium trunking connectors.

Code	Description	Kg
968255	Trunking Metal Connectors pair	0,050

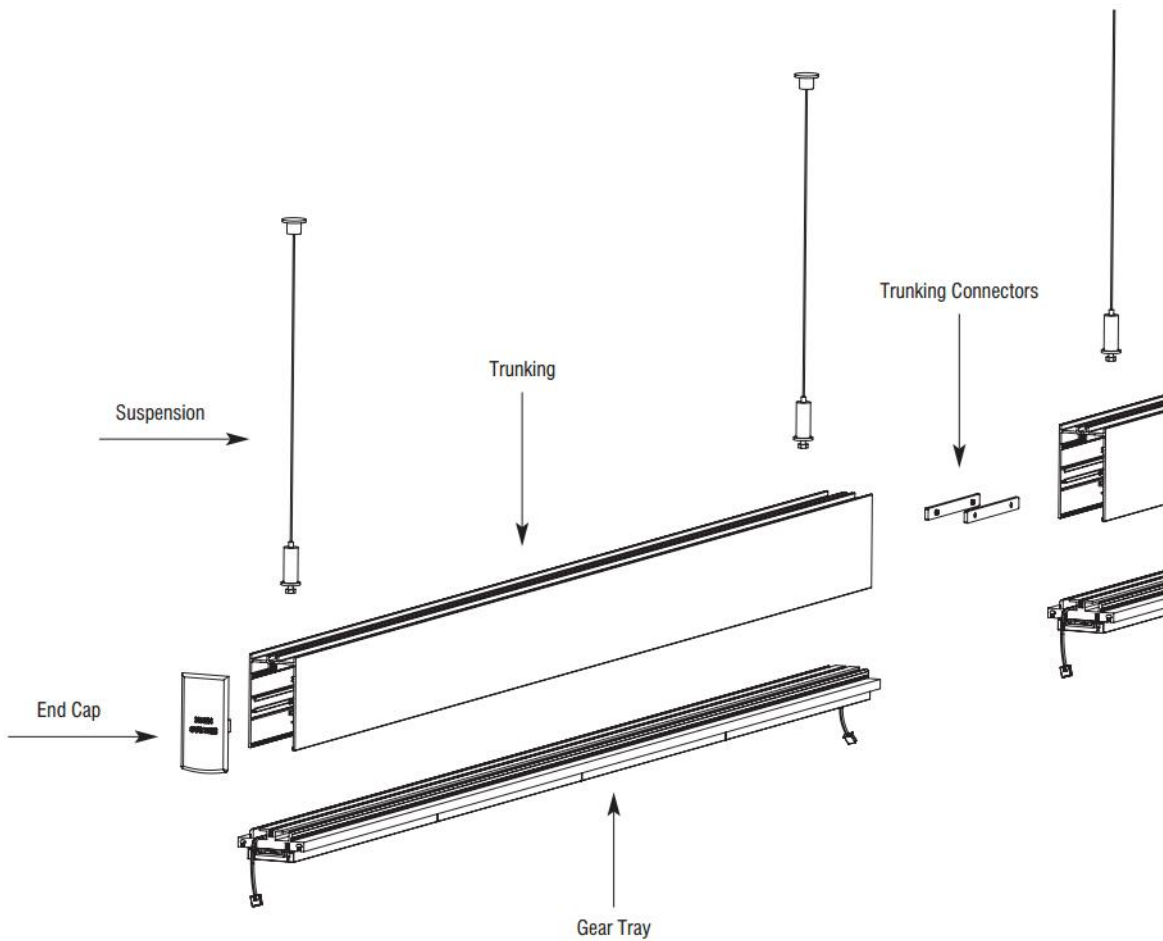

IKAROS

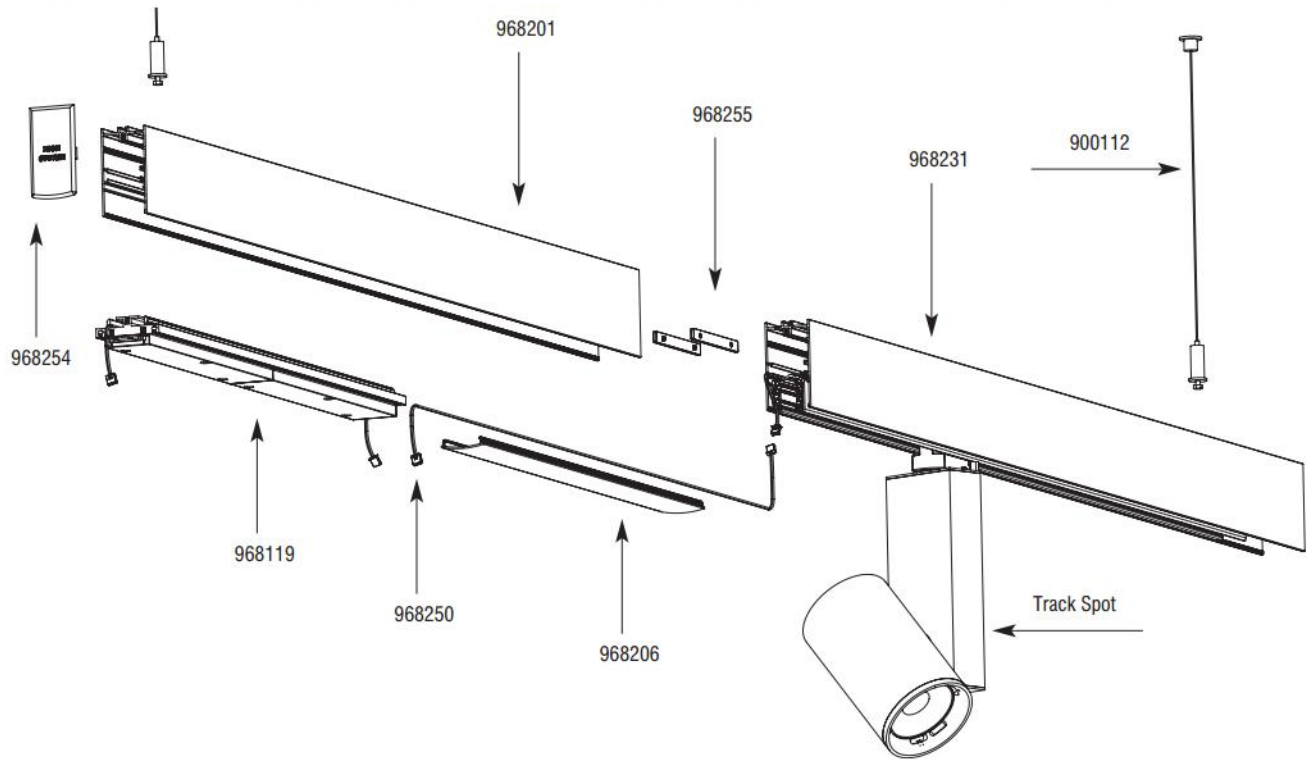

ORDER EXAMPLE

Suspension	Power Supply	Trunking	End Caps	Trunking Connectors	Gear Tray	Trunking Metal Cover	Cable Connections	Trunking+3ph. Track
<b>CODE</b>	<b>CODE</b>	<b>CODE</b>	<b>CODE</b>	<b>CODE</b>	<b>CODE</b>	<b>CODE</b>	<b>CODE</b>	<b>CODE</b>
900112	900123	968201	968254	968255	968119	968206	968250	968231

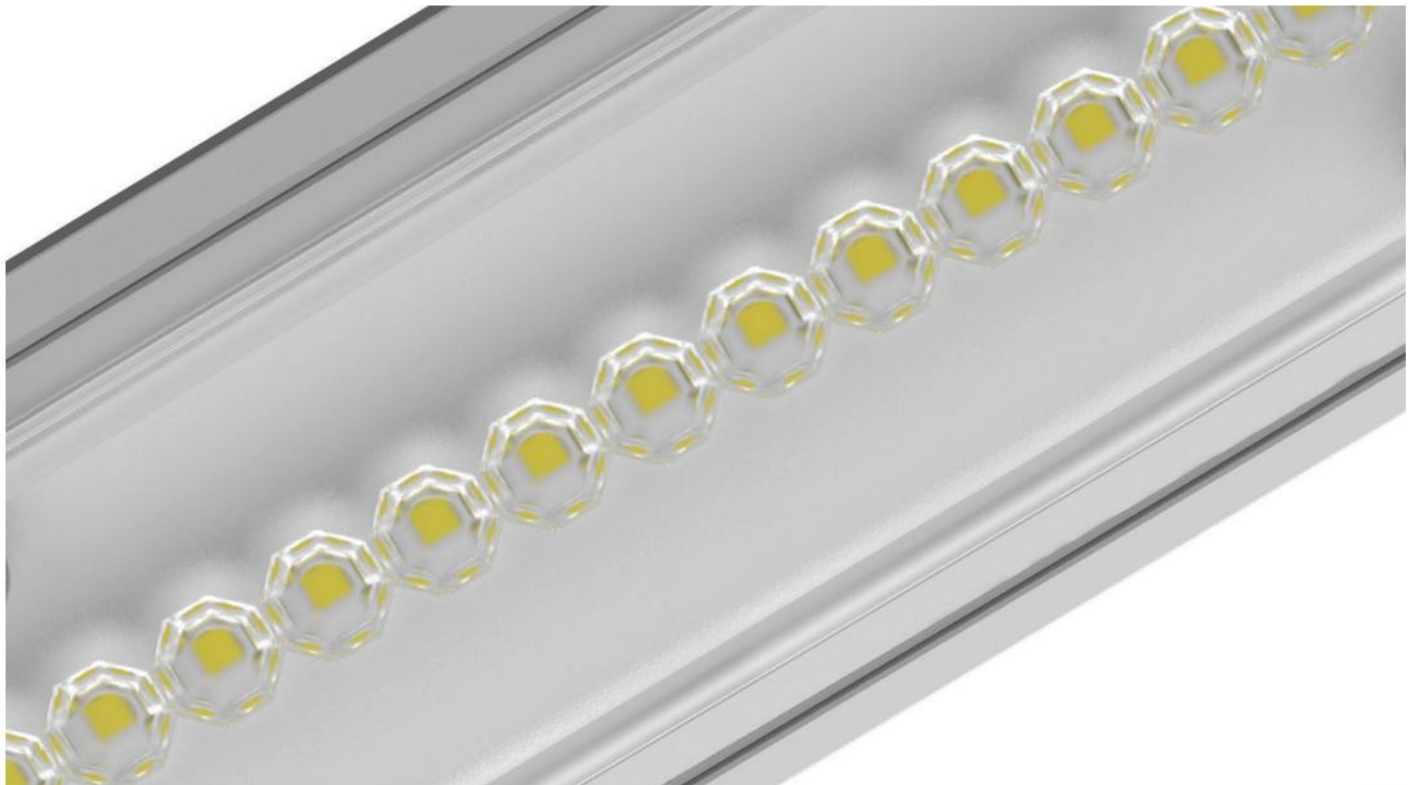

## HIGH SYSTEM / LOW SYSTEM

*This luminaire combines the architectural style with the efficiency. It produces perfect lighting conditions without annoying reflections and that is why it can be used from entrance areas to offices.*

*Uniformly illuminated lines with no dark shadows can be created thanks to the Seamless version of T16 lamps. The LED version escapes the restrictions of the T16 lamp by using LED lighting points that can have any spacing pitch and this gives the light line enormous flexibility.*

*The visual benefit: The continuous-row system is illuminated absolutely uniformly from beginning to end, is economically efficient, is maintenance-free and it has long service life.*

### Technical Features

- Housing from aluminium profile, painted electrostatically in selected colour.
- Removable plastic heads.
- High efficient diffuser in opal PMMA.
- Flow recuperator in white colour.

#### Upon request

- Connection for operation with electronic dimmable ballast.
- Available in IP54 protection version.

#### For LED Version

- Pure light without IR/UV radiation.
- Efficient thermal management.
- Up to 27W/m and 3620 Lm luminous flux range.
- Operation life: 50,000 hours with efficiency > 70% of the initial luminous flux.
- Connection for operation on 230V/50Hz.

#### Upon request:

- Available with highest colour rendering index (CRI).
- Available in IP54 protection version.



HIGH SYSTEM / LOW SYSTEM

HIGH SYSTEM

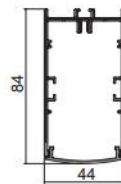
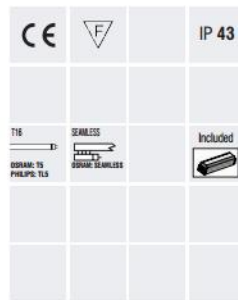

- Version for T16 and T16 SEAMLESS.
- Aluminium body.
- Removable plastic heads.
- High efficient diffuser in opal PMMA.
- Flow recuperator in white colour.
- Suspension and power supply not included.

Code	Description	L	Kg
96101	High System 1x13/14W T16	595	1,250
96103	High System 1x20/24W T16	595	1,250
96105	High System 1x19/21W T16	895	1,820
96107	High System 1x34/39W T16	895	1,820
96109	High System 1x25/28W T16	1195	2,200
96111	High System 1x50/54W T16	1195	2,200
96113	High System 1x32/35W T16	1495	2,950
96115	High System 1x45/49W T16	1495	2,950
96137	High System 1x14W T16 Seamless	595	1,150
96139	High System 1x24W T16 Seamless	595	1,150
96141	High System 1x21W T16 Seamless	895	1,680
96143	High System 1x39W T16 Seamless	895	1,680
96145	High System 1x28W T16 Seamless	1195	2,200
96147	High System 1x54W T16 Seamless	1195	2,200
96153	High System 1+ 1x21W T16 Seamless	1785	3,700
96155	High System 1+ 1x39W T16 Seamless	1785	3,700
96157	High System 1+ 1x28W T16 Seamless	2385	4,400
96159	High System 1+ 1x54W T16 Seamless	2385	4,400

HIGH SYSTEM LED

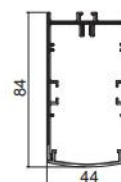

- Version for LED CHIP.
- Aluminium body.
- Removable plastic heads.
- High efficient diffuser in opal PMMA.
- Flow recuperator in white colour.
- Suspension and power supply not included.
- Efficiency: 145 Lumen / Watt.

Code	Description	L	Kg
96173	High System Led 15W 2170 lm Neutral	595	1,500
96174	High System Led 23W 3260 lm Neutral	875	2,100
96175	High System Led 30W 4340 lm Neutral	1155	2,500
96176	High System Led 38W 5430 lm Neutral	1435	3,200
96177	High System Led 15W 1990 lm Warm	595	1,500
96178	High System Led 23W 2990 lm Warm	875	2,100
96179	High System Led 30W 3980 lm Warm	1155	2,500
96180	High System Led 38W 4980 lm Warm	1435	3,200

Colour Codes:

- 0 Colours 1 White 2 Titan 3 Black 5 matt Alum.





HIGH SYSTEM / LOW SYSTEM

LOW SYSTEM

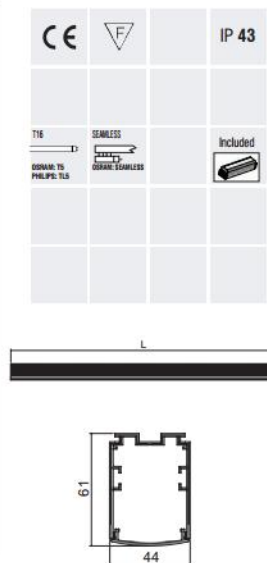

- Version for T16 and T16 SEAMLESS.
- Aluminium body.
- Removable plastic heads.
- High efficient diffuser in opal PMMA.
- Flow recuperator in white colour.
- Suspension and power supply not included.

Code	Description	L	Kg
97501	Low System 1x13/14W T16	595	1,100
97503	Low System 1x20/24W T16	595	1,100
97505	Low System 1x19/21W T16	895	1,300
97507	Low System 1x34/39W T16	895	1,300
97509	Low System 1x25/28W T16	1195	1,980
97511	Low System 1x50/54W T16	1195	1,980
97513	Low System 1x32/35W T16	1495	2,400
97515	Low System 1x45/49W T16	1495	2,400
97537	Low System 1x14W T16 Seamless	595	1,000
97539	Low System 1x24W T16 Seamless	595	1,000
97541	Low System 1x21W T16 Seamless	895	1,550
97543	Low System 1x39W T16 Seamless	895	1,550
97545	Low System 1x28W T16 Seamless	1195	2,000
97547	Low System 1x54W T16 Seamless	1195	2,000
97553	Low System 1 + 1x21W T16 Seamless	1785	2,970
97555	Low System 1 + 1x39W T16 Seamless	1785	2,970
97557	Low System 1 + 1x28W T16 Seamless	2385	3,500
97559	Low System 1 + 1x54W T16 Seamless	2385	3,500

LOW SYSTEM LED

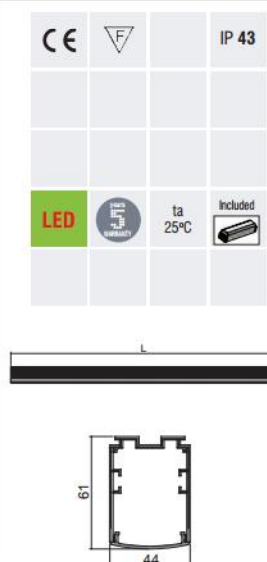

- Version for LED CHIP.
- Aluminium body.
- Removable plastic heads.
- High efficient diffuser in opal PMMA.
- Flow recuperator in white colour.
- Suspension and power supply not included.
- Efficiency: 145 Lumen / Watt.

Code	Description	L	Kg
97573	Low System Led 15W 2170 lm Neutral	595	1,300
97574	Low System Led 23W 3260 lm Neutral	875	1,600
97575	Low System Led 30W 4340 lm Neutral	1155	2,200
97576	Low System Led 38W 5430 lm Neutral	1435	2,600
97577	Low System Led 15W 1990 lm Warm	595	1,300
97578	Low System Led 23W 2990 lm Warm	875	1,600
97579	Low System Led 30W 3980 lm Warm	1155	2,200
97580	Low System Led 38W 4980 lm Warm	1435	2,600

Colour Codes:

- 0 Colours   1 White   2 Titan   3 Black   5 matt Alum.

HIGH SYSTEM DOUBLE

HIGH SYSTEM DOUBLE

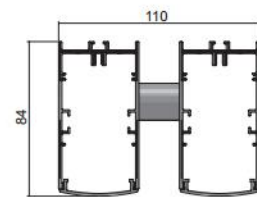
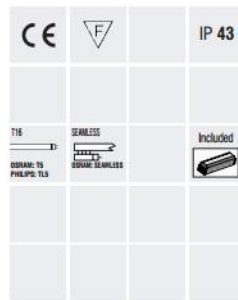

- Version for T16 and T16 SEAMLESS.
- Aluminium body.
- Removable plastic heads.
- High efficient diffuser in opal PMMA.
- Flow recuperator in white colour.
- Suspension and power supply not included.

Code	Description	L	Kg
96405	High System Double 2x19/21W T16	895	4,000
96407	High System Double 2x34/39W T16	895	4,000
96409	High System Double 2x25/28W T16	1195	4,750
96411	High System Double 2x50/54W T16	1195	4,750
96413	High System Double 2x32/35W T16	1495	5,750
96415	High System Double 2x45/49W T16	1495	5,750
96423	High System Double 2x21W T16 Seamless	895	4,000
96425	High System Double 2x39W T16 Seamless	895	4,000
96427	High System Double 2x28W T16 Seamless	1195	4,750
96429	High System Double 2x54W T16 Seamless	1195	4,750

HIGH SYSTEM DOUBLE LED

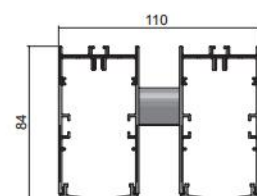

- Version for LED CHIP.
- Aluminium body.
- Removable plastic heads.
- High efficient diffuser in opal PMMA.
- Flow recuperator in white colour.
- Suspension and power supply not included.
- Efficiency: 145 Lumen / Watt.

Code	Description	L	Kg
96474	High System Double Led 2x23W 2x3260 lm Neutral	875	4,200
96475	High System Double Led 2x30W 2x4340 lm Neutral	1155	5,000
96476	High System Double Led 2x38W 2x5430 lm Neutral	1435	6,000
96478	High System Double Led 2x23W 2x2990 lm Warm	875	4,200
96479	High System Double Led 2x30W 2x3980 lm Warm	1155	5,000
96480	High System Double Led 2x38W 2x4980 lm Warm	1435	6,000

Colour Codes:

- 0 Colours 1 White 2 Titan 3 Black 5 matt Alum.





HIGH SYSTEM / LOW SYSTEM

HIGH SYSTEM SQUARE

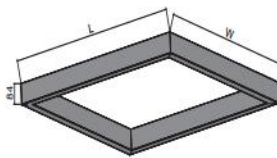
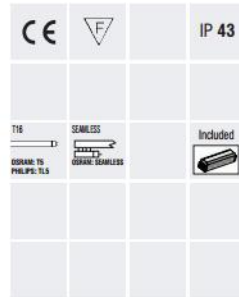

- Version for T16 and T16 SEAMLESS.
- Aluminium body.
- High efficient diffuser in opal PMMA.
- Flow recuperator in white colour.
- Suspension and power supply not included.

Code	Description	W	L	Kg
96501	High System Square 4x14W T16 SLS	640	640	4,500
96503	High System Square 4x24W T16 SLS	640	640	4,500
96505	High System Square 4x21W T16 SLS	940	940	6,200
96507	High System Square 4x39W T16 SLS	940	940	6,200
96509	High System Square 4x28W T16 SLS	1240	1240	7,900
96511	High System Square 4x54W T16 SLS	1240	1240	7,900
96513	High System Square 2x14W+2x21W T16 SLS	640	940	6,200
96515	High System Square 2x14W+2x28W T16 SLS	640	1240	7,900
96517	High System Square 2x21W+2x28W T16 SLS	940	1240	7,900
96519	High System Square 2x24W+2x39W T16 SLS	640	940	6,200
96521	High System Square 2x24W+2x54W T16 SLS	640	1240	7,900
96523	High System Square 2x39W+2x54W T16 SLS	940	1240	7,900

HIGH SYSTEM SQUARE LED

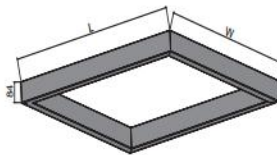

- Version for LED CHIP.
- Aluminium body.
- Removable plastic heads.
- High efficient diffuser in opal PMMA.
- Flow recuperator in white colour.
- Suspension and power supply not included.
- Efficiency: 145 Lumen / Watt.

Code	Description	W	L	Kg
96573	High System Square Led 4x23W 13040 lm Neutral	900	900	5,800
96574	High System Square Led 4x30W 17360 lm Neutral	1180	1180	7,650
96575	High System Square Led 4x38W 21720 lm Neutral	1460	1460	8,400
96576	High System Square Led 4x23W 11960 lm Warm	900	900	5,800
96577	High System Square Led 4x30W 15920 lm Warm	1180	1180	7,650
96578	High System Square Led 4x38W 19920 lm Warm	1460	1460	8,400

Colour Codes:

- 0 Colours 1 White 2 Titan 3 Black 5 matt Alum.



HIGH - LOW SYSTEM

HIGH - LOW SYSTEM UP / DOWN

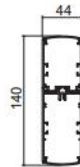

- Version for T16 and T16 SEAMLESS.
- Aluminium body.
- High efficient diffuser in opal PMMA.
- Flow recuperator in white colour.
- Suspension and power supply included.

Code	Description	L	Kg
98601	High-Low System 1x25/28W T16+1x19/21W T16	1195	4,100
98602	High-Low System 1x50/54W T16+1x34/39W T16	1195	4,100
98605	High-Low System 1x32/35W T16+1x25/28W T16	1495	4,500
98603	High-Low System 1x28W T16 SLS+1x21W T16	1195	4,100
98604	High-Low System 1x54W T16 SLS+1x39W T16	1195	4,100
98607	High-Low System 2x28W T16 SLS+2x21W T16	2385	7,400
98608	High-Low System 2x54W T16 SLS+2x39W T16	2385	7,400
98615	High-Low System Track 3-phase+1x25/28W T16	1495	4,500
98616	High-Low System Track 3-phase+1x50/54W T16	1495	4,500
98617	High-Low System Track 3-phase+1x32/35W T16	1795	5,200
98619	High-Low System Track 3-phase+2x19/21W T16	2080	6,500
98620	High-Low System Track 3-phase+2x34/39W T16	2080	6,500
98621	High-Low System Track 3-phase+2x25/28W T16	2680	7,650
98622	High-Low System Track 3-phase+2x50/54W T16	2680	7,650

HIGH - LOW SYSTEM UP / DOWN LED

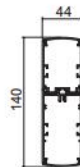
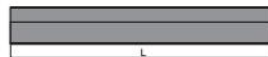
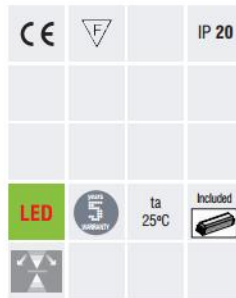

- Version for LED CHIP.
- Aluminium body.
- Removable plastic heads.
- High efficient diffuser in opal PMMA.
- Flow recuperator in white colour.
- Suspension and power supply included.
- Efficiency: 145 Lumen / Watt.

Code	Description	L	Kg
98673	High-Low System Led 23W+15W Neutral	875	3,700
98674	High-Low System Led 30W+23W Neutral	1155	4,700
98675	High-Low System Led 38W+30W Neutral	1435	5,500
98676	High-Low System Led 23W+15W Warm	875	3,700
98677	High-Low System Led 30W+23W Warm	1155	4,700
98678	High-Low System Led 38W+30W Warm	1435	5,500
98679	High-Low System Track 3-phase+15W Neutral	875	3,700
98680	High-Low System Track 3-phase+23W Neutral	1155	4,050
98681	High-Low System Track 3-phase+30W Neutral	1435	4,200
98682	High-Low System Track 3-phase+15W Warm	875	3,700
98683	High-Low System Track 3-phase+23W Warm	1155	4,050
98684	High-Low System Track 3-phase+30W Warm	1435	4,200

Colour Codes:

- 0 Colours 1 White 2 Titan 3 Black 5 matt Alum.





HIGH SYSTEM / LOW SYSTEM

HIGH SYSTEM ASTRA LED



CE	F	IP 20
LED	5 YEAR WARRANTY	ta 25°C
		Included

- Version for LED CHIP.
- Aluminium body.
- Removable plastic heads.
- Suspension and power supply not included.
- Efficiency: 107 Lumen / Watt.

Code	Description	L	Kg
96201	High System Astra Led 6x1W Neutral	560	1,500
96202	High System Astra Led 12x1W Neutral	1060	2,000
96203	High System Astra Led 18x1W Neutral	1560	2,500
96205	High System Astra Led 6x1W Warm	560	1,500
96206	High System Astra Led 12x1W Warm	1060	2,000
96207	High System Astra Led 18x1W Warm	1560	2,500
96209	High System Astra Led 6x2W Neutral	560	1,500
96210	High System Astra Led 12x2W Neutral	1060	2,000
96211	High System Astra Led 18x2W Neutral	1560	2,500
96213	High System Astra Led 6x2W Warm	560	1,500
96214	High System Astra Led 12x2W Warm	1060	2,000
96215	High System Astra Led 18x2W Warm	1560	2,500

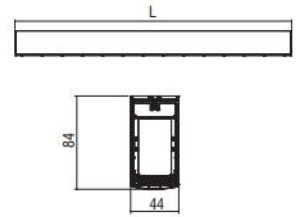

Colour Codes:

- 0 Colours 1 White 2 Titan 3 Black 5 matt Alum.

HIGH SYSTEM UP/DOWN SIDE

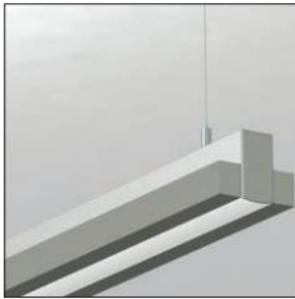

CE	F	IP 20
T16	OSRAM T5 PHILIPS T16	Included

- Version for T16.
- Aluminium body.
- High efficient diffuser in opal PMMA.
- Flow recuperator in white colour.
- Suspension and power supply included.

Code	Description	L	Kg
96221	High System Up/Down Side 1x50/54W+2x25/28W T16	1195	5,400
96222	High System Up/Down Side 1x73/80W+2x32/35W T16	1495	6,100

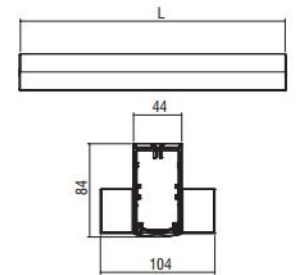

HIGH SYSTEM UP/DOWN SIDE LED

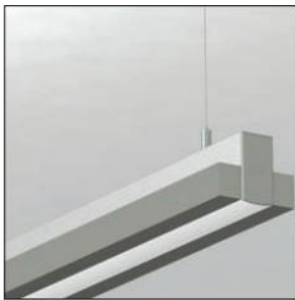

CE	F	IP 20
T16	OSRAM T5 PHILIPS T16	Included
LED	5 YEAR WARRANTY	ta 25°C

- Version for LED and T16.
- Aluminium body.
- High efficient diffuser in opal PMMA.
- Flow recuperator in white colour.
- Suspension and power supply included.
- Efficiency: 145 Lumen / Watt.

Code	Description	L	Kg
96226	High System Up/Down Led 30W Led+2x25/28W T16 Neutral	1195	5,400
96227	High System Up/Down Led 38W Led+2x32/35W T16 Neutral	1495	6,100
96228	High System Up/Down Led 30W Led+2x25/28W T16 Warm	1195	5,400
96229	High System Up/Down Led 38W Led+2x32/35W T16 Warm	1495	6,100

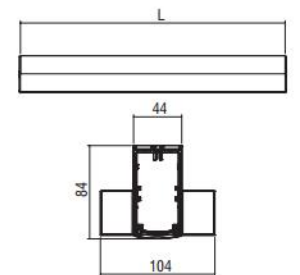

HIGH SYSTEM UP/DOWN SIDE LED SPOT

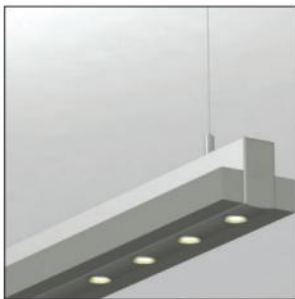

CE	F	IP 20
LED	5 YEAR WARRANTY	ta 25°C
		Included

- Version for LED and T16.
- Aluminium body.
- Suspension and power supply included.
- Efficiency: 107 Lumen / Watt.

Code	Description	L	Kg
96235	High System Up/Down Led Spot 6x2W Led+2x25/28W T16 Neutral	1195	5,400
96236	High System Up/Down Led Spot 8x2W Led+2x32/35W T16 Neutral	1495	6,100
96237	High System Up/Down Led Spot 6x2W Led+2x25/28W T16 Warm	1195	5,400
96238	High System Up/Down Led Spot 8x2W Led+2x32/35W T16 Warm	1495	6,100

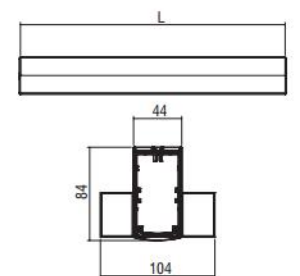

Colour Codes:

- 0 Colours 1 White 2 Titan 3 Black

HIGH SYSTEM / LOW SYSTEM

HIGH SYSTEM + Module 30



- Version for LED CHIP.
- Aluminium body.
- Lens in Spot, Medium, Wide or spot reflector selection.
- Efficiency: 107 Lumen / Watt.

Code	Description	L	Kg
96301	High System Module 30 1x2W Lens	240	1,800
96302	High System Module 30 2x2W Lens	320	2,100
96303	High System Module 30 3x2W Lens	400	4,000
96304	High System Module 30 1x2W Reflector	240	1,800
96305	High System Module 30 2x2W Reflector	320	2,100
96306	High System Module 30 3x2W Reflector	400	4,000

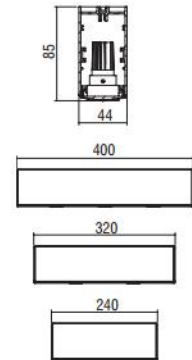

**LED COLOUR CODES:**  
 2 Warm 3 Neutral

**BEAM CODES:**  
 01 spot 02 medium 03 wide

**Colour Codes:**  
 0 Colours 1 White 2 Titan 3 Black 5 matt Alum.



HIGH SYSTEM / LOW SYSTEM ACCESSORIES

POWER SUPPLY

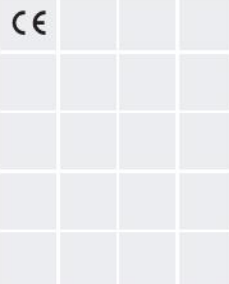

- For pendant use.
- Plastic body.
- With transparent cable 3x0,75mm<sup>2</sup>.
- Round version.

Code	Description	L	Kg
900121	Power Supply with Rosette Ø75	500	0,060
900122	Power Supply with Rosette Ø75	1000	0,120
900123	Power Supply with Rosette Ø75	1500	0,180
900124	Power Supply with Rosette Ø75	2000	0,240
900126	Power Supply with Rosette Ø75	3000	0,360

POWER SUPPLY

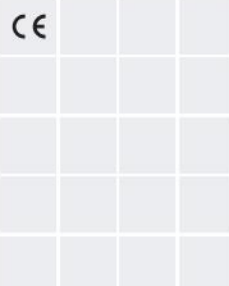

- For pendant use.
- Body from aluminium profile.
- With 2m transparent cable 3x0,75mm<sup>2</sup>.
- Square or round version.

Code	Description	Kg
90042	Power Supply L 2m with Rosette Ø80	0,130
90043	Power Supply L 2m with Rosette Ø70	0,130
90044	Power Supply L 2m with Rosette 80x80	0,210
90045	Power Supply L 2m with Rosette 70x70	0,200



SCONCE BASE

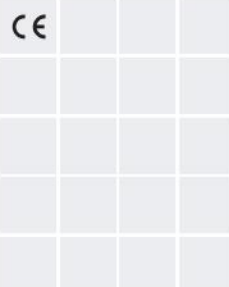

- For simple applique version.
- Body from aluminium profile.
- **Required:**  
1 base for length <or = 1650mm &  
2 bases for length > 1650mm

Code	Description	Kg
90041	Sconce Base	0,120

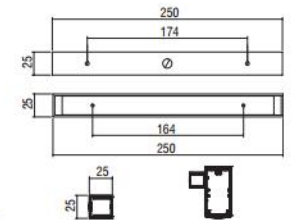

SURFACE SCONCE BASE

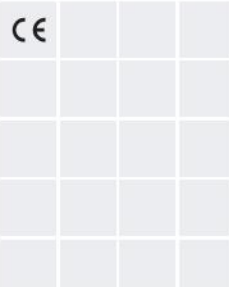

- For surface applique version.
- Body from aluminium.

Code	Description	Kg
900460	Surface Sconce Base Low (set 2 pcs.)	0,080
900470	Surface Sconce Base High (set 2 pcs.)	0,080

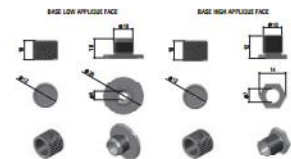

SINGLE ADJUSTABLE SUSPENSION

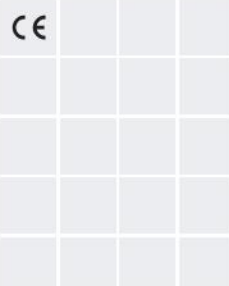
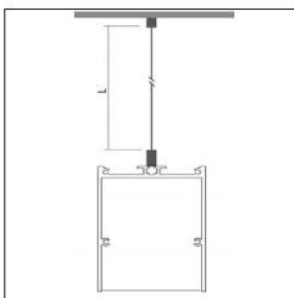

- Stainless steel cable and regulators.
- **Required:**  
2 pieces for up to 3m profile.

Code	Description	L	Kg
900111	Single Suspension	500	0,050
900112	Single Suspension	1000	0,100
900113	Single Suspension	1500	0,150
900114	Single Suspension	2000	0,200
900116	Single Suspension	3000	0,300

HIGH SYSTEM / LOW SYSTEM

SURFACE SCONCE BASE

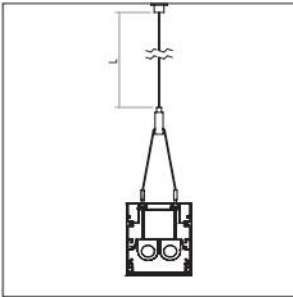

CE

- Stainless steel cable and regulators.
- **Required:**  
2 pieces for up to 3m profile.

Code	Description	L	Kg
900142	Double Suspension	1000	0,070
900143	Double Suspension	1500	0,110
900144	Double Suspension	2000	0,220

Colour Codes:

- 0 Colours   1 White   2 Titan   3 Black   5 matt Alum.



## SLOTLIGHT

*This luminaire combines the architectural style with the efficiency. It produces perfect lighting conditions without annoying reflections and that is why it can be used from entrance areas to offices. Uniformly illuminated lines with no dark shadows can be created thanks to the Tetris technology of T16 lamps. The LED version escapes the restrictions of the T16 lamp by using LED lighting points that can have any spacing pitch and this gives the light line enormous flexibility. The visual benefit: The continuous-row system is illuminated absolutely uniformly from beginning to end, is economically efficient, is maintenance-free and it has long service life.*

## Technical Features

- Housing from aluminium profile, painted electrostatically in selected colour.
- Removable plastic heads.
- High efficient diffuser in opal PMMA.
- Flow recuperator in white colour.

**Upon request**

- Connection for operation with electronic dimmable ballast.
- Available in IP54 protection version.

**For LED Version**

- Pure light without IR/UV radiation.
- Efficient thermal management.
- Up to 28W/m and 3864 Lm luminous flux range.
- Operation life: 50,000 hours with efficiency > 70% of the initial luminous flux.
- Connection for operation on 230V/50Hz.

**Upon request:**

- Available with highest colour rendering index (CRI).
- Available in IP54 protection version.



SLOTLIGHT

SLOTLIGHT

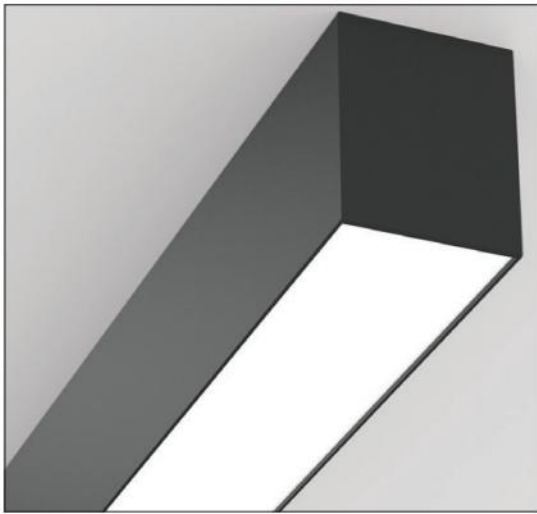

- Version for T16.
- Aluminium body.
- Removable plastic heads.
- High efficient diffuser in opal PMMA.
- Flow recuperator in white colour.
- Suspension and power supply not included.

Code	Description	L	Kg
90101	Slotlight 1x13/14W T16	585	1,650
90103	Slotlight 1x20/24W T16	585	1,650
90105	Slotlight 1x19/21W T16	885	2,350
90107	Slotlight 1x34/39W T16	885	2,400
90109	Slotlight 1x25/28W T16	1185	3,600
90111	Slotlight 1x50/54W T16	1185	3,600
90113	Slotlight 1x32/35W T16	1485	3,750
90115	Slotlight 1x45/49W T16	1485	3,750
90117	Slotlight 1x73/80W T16	1485	3,750
90137	Slotlight 2x13/14W T16	585	1,980
90139	Slotlight 2x20/24W T16	585	1,980
90141	Slotlight 2x19/21W T16	885	2,360
90143	Slotlight 2x34/39W T16	885	2,360
90145	Slotlight 2x25/28W T16	1185	3,670
90147	Slotlight 2x50/54W T16	1185	3,670
90149	Slotlight 2x32/35W T16	1485	3,870
90151	Slotlight 2x45/49W T16	1485	3,870
90119	Slotlight 1 + 1x13/14W T16	1050	2,900
90121	Slotlight 1 + 1x20/24W T16	1050	2,900
90123	Slotlight 1 + 1x19/21W T16	1650	3,500
90125	Slotlight 1 + 1x34/39W T16	1650	3,500
90127	Slotlight 1 + 1x25/28W T16	2250	5,850
90129	Slotlight 1 + 1x50/54W T16	2250	5,880
90131	Slotlight 1 + 1x32/35W T16	2850	7,230
90133	Slotlight 1 + 1x45/49W T16	2850	7,230
90135	Slotlight 1 + 1x73/80W T16	2850	7,230
90155	Slotlight 2 + 2x13/14W T16	1262	3,500
90157	Slotlight 2 + 2x20/24W T16	1262	3,500
90159	Slotlight 2 + 2x19/21W T16	1862	5,300
90161	Slotlight 2 + 2x34/39W T16	1862	5,300
90163	Slotlight 2 + 2x25/28W T16	2462	7,130
90165	Slotlight 2 + 2x50/54W T16	2462	7,130
90167	Slotlight 2 + 2x32/35W T16	3062	9,400
90169	Slotlight 2 + 2x45/49W T16	3062	9,400

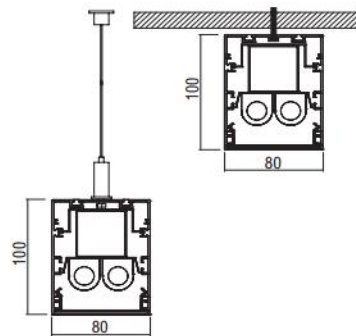

CE	F	IP 43
T16		
GEARLESS T16 PHILIPS T16		
		Included

Colour Codes:

0	Colours	1	White	2	Titan	3	Black	5	matt Alum.	9	Anodized
---	---------	---	-------	---	-------	---	-------	---	------------	---	----------

SLOTLIGHT

SLOTLIGHT LED

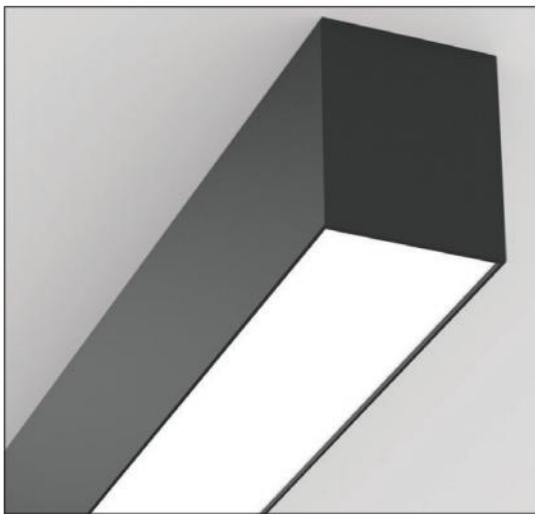

- Version for LED CHIP.
- Aluminium body.
- Removable plastic heads.
- High efficient diffuser in opal PMMA.
- Flow recuperator in white colour.
- Suspension and power supply not included.
- Efficiency: max.138 Lumen / Watt.

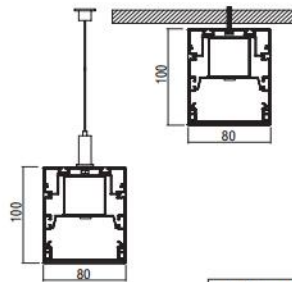

Code	Description	L	Kg
90173	Slotlight Led 16W 2200 lm Neutral	600	1,800
90174	Slotlight Led 28W 3100 lm Neutral	1160	3,500
90175	Slotlight Led 33W 4400 lm Neutral	1160	3,500
90176	Slotlight Led 42W 4650 lm Neutral	1720	4,500
90177	Slotlight Led 49W 6600 lm Neutral	1720	4,500
90178	Slotlight Led 56W 6200 lm Neutral	2280	5,900
90179	Slotlight Led 65W 8800 lm Neutral	2280	5,900
90180	Slotlight Led 16W 2200 lm Warm	600	1,800
90182	Slotlight Led 33W 4400 lm Warm	1160	3,500
90184	Slotlight Led 49W 6600 lm Warm	1720	4,500
90186	Slotlight Led 65W 8800 lm Warm	2280	5,900

Colour Codes:

- 0 Colours   1 White   2 Titan   3 Black   5 matt Alum.   9 Anodized



SLOTLIGHT

SLOTLIGHT ANAGLYPH

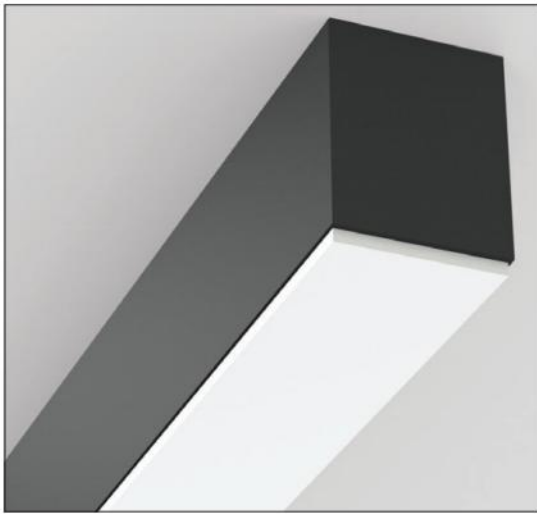

- Version for T16.
- Aluminium body.
- Removable plastic heads.
- Diffuser in opal of 10mm PMMA.
- Flow recuperator in white colour.
- Suspension and power supply not included.

Code	Description	L	Kg
90801	Slotlight Anaglyph 1x13/14W T16	585	1,970
90803	Slotlight Anaglyph 1x20/24W T16	585	1,970
90805	Slotlight Anaglyph 1x19/21W T16	885	3,000
90807	Slotlight Anaglyph 1x34/39W T16	885	3,000
90809	Slotlight Anaglyph 1x25/28W T16	1185	3,950
90811	Slotlight Anaglyph 1x50/54W T16	1185	3,950
90813	Slotlight Anaglyph 1x32/35W T16	1485	5,500
90815	Slotlight Anaglyph 1x45/49W T16	1485	5,500
90817	Slotlight Anaglyph 1x73/80W T16	1485	5,500
90837	Slotlight Anaglyph 2x13/14W T16	585	2,500
90839	Slotlight Anaglyph 2x20/24W T16	585	2,500
90841	Slotlight Anaglyph 2x19/21W T16	885	1,970
90843	Slotlight Anaglyph 2x34/39W T16	885	1,970
90845	Slotlight Anaglyph 2x25/28W T16	1185	4,280
90847	Slotlight Anaglyph 2x50/54W T16	1185	4,280
90849	Slotlight Anaglyph 2x32/35W T16	1485	5,500
90851	Slotlight Anaglyph 2x45/49W T16	1485	5,500
90819	Slotlight Anaglyph 1 + 1x13/14W T16	1050	3,900
90821	Slotlight Anaglyph 1 + 1x20/24W T16	1050	3,900
90823	Slotlight Anaglyph 1 + 1x19/21W T16	1650	6,000
90825	Slotlight Anaglyph 1 + 1x34/39W T16	1650	6,000
90827	Slotlight Anaglyph 1 + 1x25/28W T16	2250	7,800
90829	Slotlight Anaglyph 1 + 1x50/54W T16	2250	7,800
90831	Slotlight Anaglyph 1 + 1x32/35W T16	2850	10,960
90833	Slotlight Anaglyph 1 + 1x45/49W T16	2850	10,960
90835	Slotlight Anaglyph 1 + 1x73/80W T16	2850	10,960
90855	Slotlight Anaglyph 2 + 2x13/14W T16	1262	4,500
90857	Slotlight Anaglyph 2 + 2x20/24W T16	1262	4,500
90859	Slotlight Anaglyph 2 + 2x19/21W T16	1862	6,500
90861	Slotlight Anaglyph 2 + 2x34/39W T16	1862	6,500
90863	Slotlight Anaglyph 2 + 2x25/28W T16	2462	8,500
90865	Slotlight Anaglyph 2 + 2x50/54W T16	2462	8,500
90867	Slotlight Anaglyph 2 + 2x32/35W T16	3062	10,200
90869	Slotlight Anaglyph 2 + 2x45/49W T16	3062	10,200

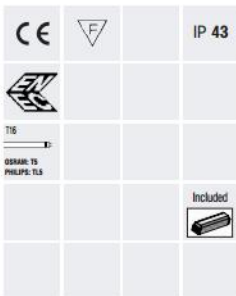
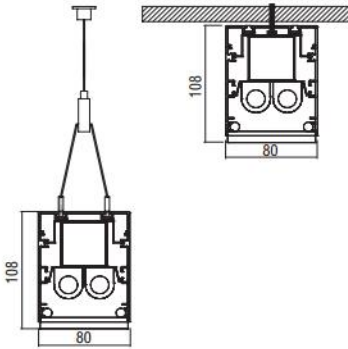

Colour Codes:

- 0 Colours 1 White 2 Titan 3 Black 5 matt Alum. 9 Anodized





SLOTLIGHT

SLOTLIGHT ANAGLYPH LED

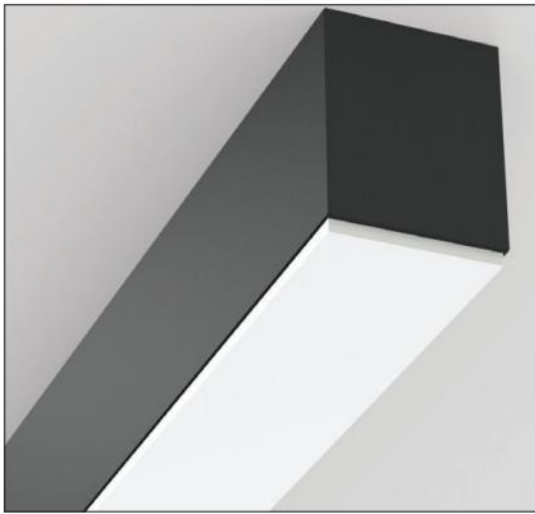

- Version for LED CHIP.
- Aluminium body.
- Removable plastic heads.
- Diffuser in opal of 10mm PMMA.
- Flow recuperator in white colour.
- Suspension and power supply not included.
- Efficiency: max.138 Lumen / Watt.

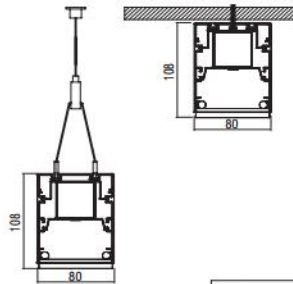

Code	Description	L	Kg
90873	Slotlight An. Led 16W 2200 lm Neutral	600	1,800
90874	Slotlight An.Led 28W 3100 lm Neutral	1160	3,500
90875	Slotlight An.Led 33W 4400 lm Neutral	1160	3,500
90876	Slotlight An.Led 42W 4650 lm Neutral	1720	4,500
90877	Slotlight An.Led 49W 6600 lm Neutral	1720	4,500
90878	Slotlight An.Led 56W 6200 lm Neutral	2280	5,900
90879	Slotlight An.Led 65W 8800 lm Neutral	2280	5,900
90880	Slotlight An.Led 16W 2200 lm Warm	600	1,800
90882	Slotlight An.Led 33W 4400 lm Warm	1160	3,500
90884	Slotlight An.Led 49W 6600 lm Warm	1720	4,500
90886	Slotlight An.Led 65W 8800 lm Warm	2280	5,900

Colour Codes:

- 0 Colours   1 White   2 Titan   3 Black   5 matt Alum.   9 Anodized



SLOTLIGHT

SLOTLIGHT DOUBLE

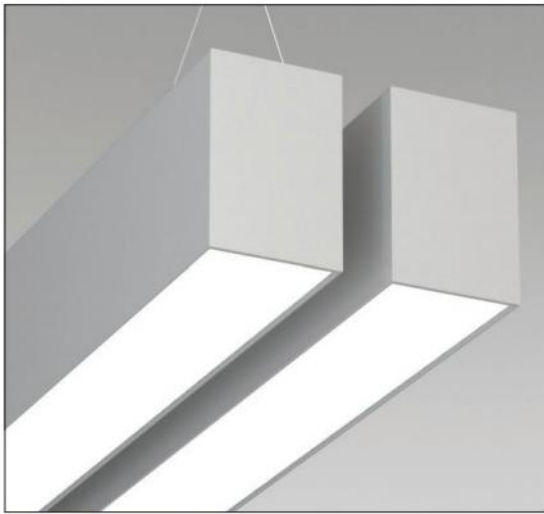

- Version for T16.
- Aluminium body.
- Removable plastic heads.
- High efficient diffuser in opal PMMA.
- Flow recuperator in white colour.
- Suspension and power supply not included.

Code	Description	L	Kg
90343	Slotlight Double 2x34/39W T16	885	4,750
90345	Slotlight Double 2x25/28W T16	1185	6,360
90347	Slotlight Double 2x50/54W T16	1185	6,360
90349	Slotlight Double 2x32/35W T16	1485	7,970
90351	Slotlight Double 2x45/49W T16	1485	7,970
90353	Slotlight Double 2x73/80W T16	1485	7,970
90361	Slotlight Double 4x34/39W T16	885	4,750
90363	Slotlight Double 4x25/28W T16	1185	6,900
90365	Slotlight Double 4x50/54W T16	1185	6,900
90367	Slotlight Double 4x32/35W T16	1485	7,970
90369	Slotlight Double 4x45/49W T16	1485	7,970

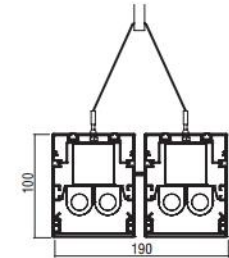
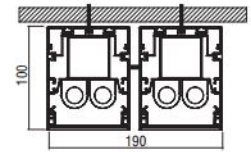

CE	F	IP 43
T16		Included

SLOTLIGHT DOUBLE LED

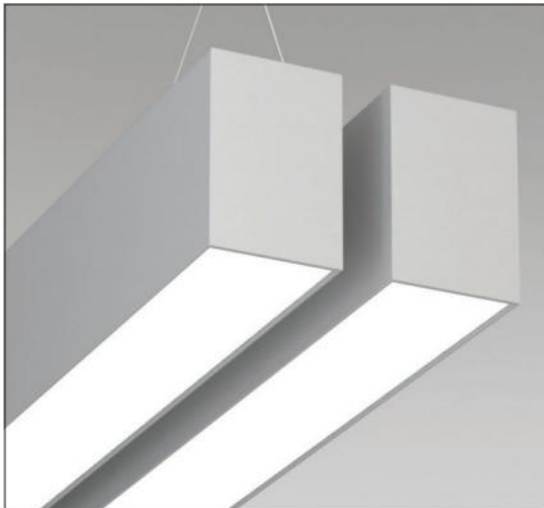

- Version for LED CHIP.
- Aluminium body.
- Removable plastic heads.
- High efficient diffuser in opal PMMA.
- Flow recuperator in white colour.
- Suspension and power supply not included.
- Efficiency: max.138 Lumen / Watt.

Code	Description	L	Kg
90373	Slotlight Double Led 2x28W 6200 lm Neutral	1160	5,200
90374	Slotlight Double Led 2x33W 8800 lm Neutral	1160	5,200
90375	Slotlight Double Led 2x42W 9300 lm Neutral	1720	8,760
90376	Slotlight Double Led 2x49W 13200 lm Neutral	1720	8,760
90380	Slotlight Double Led 2x33W 8800 lm Warm	1160	5,200
90382	Slotlight Double Led 2x49W 13200 lm Warm	1720	8,760

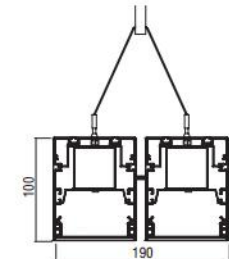
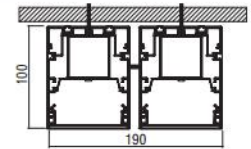

CE	F	IP 43
LED	ta 25°C	Included

Colour Codes:

- 0 Colours 1 White 2 Titan 3 Black 5 matt Alum. 9 Anodized







SLOTLIGHT

SLOTLIGHT DOUBLE ANAGLYPH

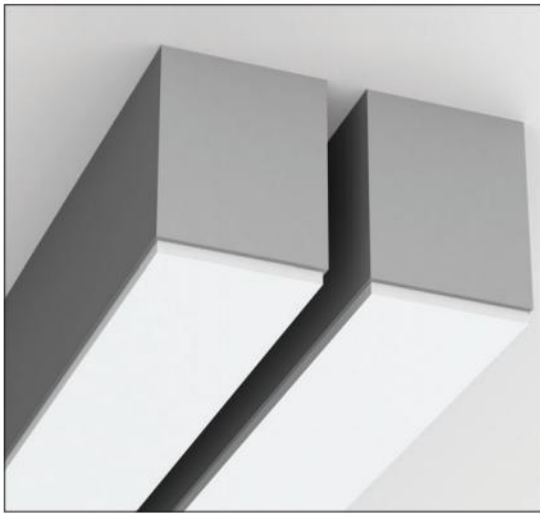

- Version for T16.
- Aluminium body.
- Removable plastic heads.
- Diffuser in opal of 10mm PMMA.
- Flow recuperator in white colour.
- Suspension and power supply not included.

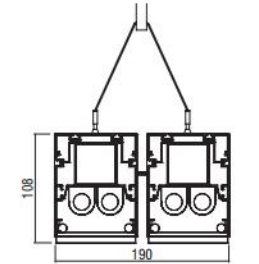
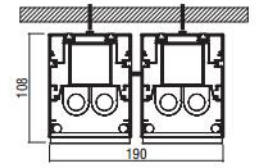

Code	Description	L	Kg
90943	Slotlight Double Anaglyph 2x34/39W T16	885	7,300
90945	Slotlight Double Anaglyph 2x25/28W T16	1185	8,800
90947	Slotlight Double Anaglyph 2x50/54W T16	1185	8,800
90949	Slotlight Double Anaglyph 2x32/35W T16	1485	9,970
90951	Slotlight Double Anaglyph 2x45/49W T16	1485	9,970
90953	Slotlight Double Anaglyph 2x73/80W T16	1485	9,970
90961	Slotlight Double Anaglyph 4x34/39W T16	885	7,300
90963	Slotlight Double Anaglyph 4x25/28W T16	1185	8,800
90965	Slotlight Double Anaglyph 4x50/54W T16	1185	8,800
90967	Slotlight Double Anaglyph 4x32/35W T16	1485	9,970
90969	Slotlight Double Anaglyph 4x45/49W T16	1485	9,970

CE	F	IP 43
T16		Included
OSRAM: T5 PHILIPS: T5L		

SLOTLIGHT DOUBLE ANAGLYPH LED

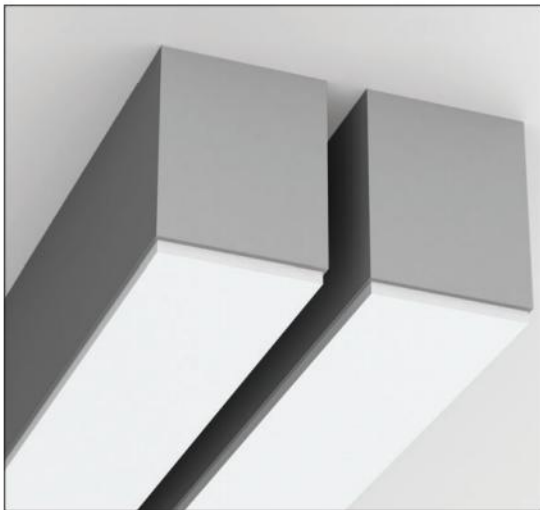

- Version for LED CHIP.
- Aluminium body.
- Removable plastic heads.
- Diffuser in opal of 10mm PMMA.
- Flow recuperator in white colour.
- Suspension and power supply not included.
- Efficiency: max.138 Lumen / Watt.

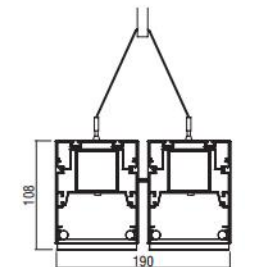
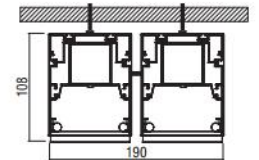

Code	Description	L	Kg
90973	Slotlight Double An. Led 2x28W 6200 lm Neutral	1160	8,700
90974	Slotlight Double An. Led 2x33W 8800 lm Neutral	1160	8,700
90975	Slotlight Double An. Led 2x42W 9300 lm Neutral	1720	11,200
90976	Slotlight Double An. Led 2x49W 13200 lm Neutral	1720	11,200
90980	Slotlight Double An. Led 2x33W 8800 lm Warm	1160	8,700
90982	Slotlight Double An. Led 2x49W 13200 lm Warm	1720	11,200

CE	F	IP 43
LED		Included
ta 25°C		

Colour Codes:

- 0 Colours 1 White 2 Titan 3 Black 5 matt Alum. 9 Anodized

SLOTLIGHT

SLOTLIGHT SQUARE



- Version for T16.
- Aluminium body.
- High efficient diffuser in opal PMMA.
- Flow recuperator in white colour.
- Suspension and power supply not included.

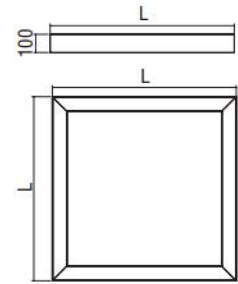

Code	Description	L	Kg
90601	Slotlight Square 4x20/24W T16	700	6,510
90605	Slotlight Square 4x34/39W T16	1000	9,300
90607	Slotlight Square 4x50/54W T16	1300	14,160
90609	Slotlight Square 4x73/80W T16	1600	18,700
90603	Slotlight Square 8x20/24W T16	700	6,810
90606	Slotlight Square 8x34/39W T16	1000	9,500
90608	Slotlight Square 8x50/54W T16	1300	14,320
90602	Slotlight Square 4x20/24W T16+4x Led / GU10	700	6,510
90604	Slotlight Square 8x20/24W T16+4x Led / GU10	700	6,710



SLOTLIGHT SQUARE LED



- Version for LED CHIP.
- Aluminium body.
- Removable plastic heads.
- High efficient diffuser in opal PMMA.
- Flow recuperator in white colour.
- Suspension and power supply not included.
- Efficiency: max. 138 Lumen / Watt.

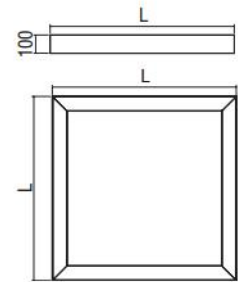

Code	Description	L	Kg
90611	Slotlight Square Led 4x28W 12400 lm Neutral	1215	14,130
90612	Slotlight Square Led 4x33W 17600 lm Neutral	1215	14,130
90613	Slotlight Square Led 4x42W 18600 lm Neutral	1780	21,350
90614	Slotlight Square Led 4x49W 26400 lm Neutral	1780	21,350
90618	Slotlight Square Led 4x33W 17600 lm Warm	1215	14,130
90620	Slotlight Square Led 4x49W 26400 lm Warm	1780	21,350



Colour Codes:

- 0 Colours 1 White 2 Titan 3 Black 5 matt Alum. 9 Anodized





SLOTLIGHT

SLOTLIGHT UP / DOWN

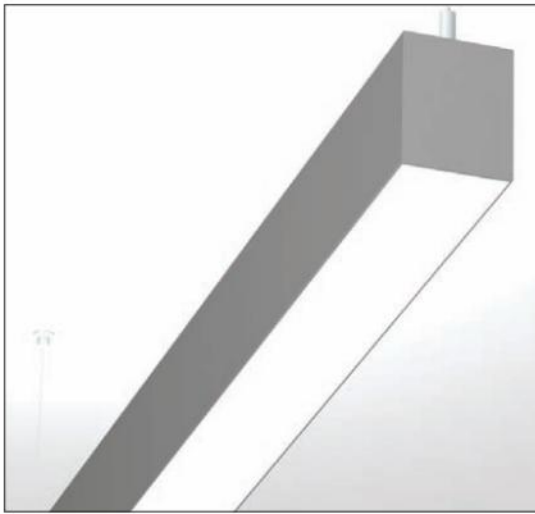

- Version for T16.
- Aluminium body.
- Removable plastic heads.
- High efficient diffuser in opal PMMA.
- Flow recuperator in white colour.
- Suspension and power supply included.

Code	Description	L	Kg
92905	Slotlight U/D 1x21W + 1x14W	885	2,390
92907	Slotlight U/D 1x39W + 1x14W	885	2,390
92909	Slotlight U/D 1x28W + 1x21W	1185	3,200
92911	Slotlight U/D 1x54W + 1x21W	1185	3,200
92913	Slotlight U/D 1x35W + 1x28W	1485	3,750
92915	Slotlight U/D 1x49W + 1x28W	1485	3,750
92923	Slotlight U/D 2x21W + 2x14W	1650	4,350
92925	Slotlight U/D 2x39W + 2x14W	1650	4,350
92927	Slotlight U/D 2x28W + 2x21W	2250	6,100
92929	Slotlight U/D 2x54W + 2x21W	2250	6,100
92931	Slotlight U/D 2x35W + 2x28W	2850	7,670
92933	Slotlight U/D 2x49W + 2x28W	2850	7,670

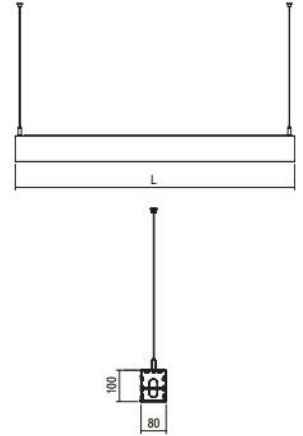

CE	F	IP 43
ELC		
T16		Included
OSRAM: T6 PHILIPS: T6.5		

SLOTLIGHT UP / DOWN LED

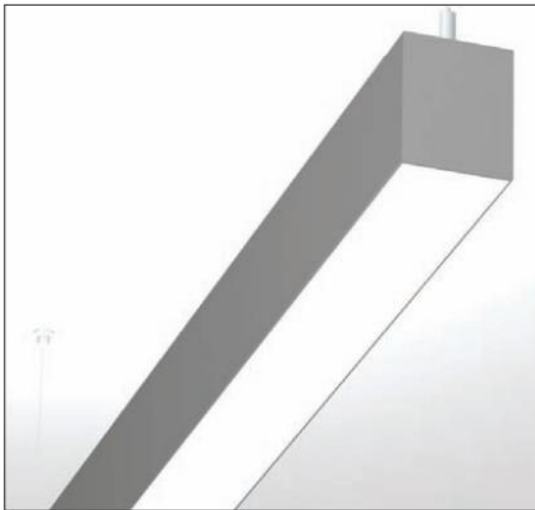

- Version for LED CHIP.
- Aluminium body.
- Removable plastic heads.
- High efficient diffuser in opal PMMA.
- Flow recuperator in white colour.
- Suspension and power supply included.
- Efficiency: max.138 Lumen / Watt.

Code	Description	L	Kg
92973	Slotlight U/D Led 33W + 16W 4400 + 2200 lm Neutral	1160	2,400
92974	Slotlight U/D Led 49W + 33W 6600 + 4400 lm Neutral	1720	3,570
92975	Slotlight U/D Led 49W + 16W 6600 + 2200 lm Neutral	1720	3,570
92976	Slotlight U/D Led 33W + 16W 4400 + 2200 lm Warm	1160	2,400
92977	Slotlight U/D Led 49W + 33W 6600 + 4400 lm Warm	1720	3,570
92978	Slotlight U/D Led 49W + 16W 6600 + 2200 lm Warm	1720	3,570

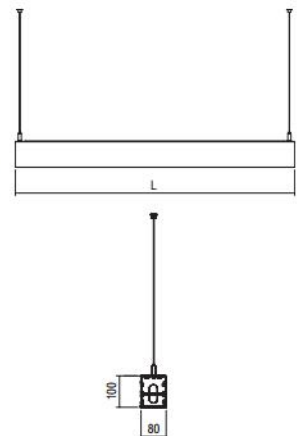

CE	F	IP 43
ELC		
LED	LED 25°C	Included

**Colour Codes:**

0	Colours	1	White	2	Titan	3	Black	5	matt Alum.	9	Anodized
---	---------	---	-------	---	-------	---	-------	---	------------	---	----------

SLOTLIGHT

SLOTLIGHT UP / DOWN LOUVRE

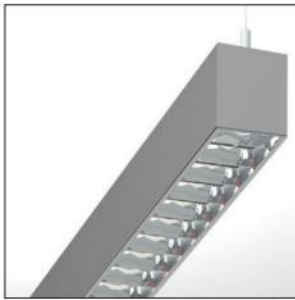

CE	F	IP 43
		Included
T16		
DESIGNED TO PHILIPS T16		

- Version for T16.
- Aluminium body.
- Removable plastic heads.
- High efficient diffuser in opal PMMA.
- Flow recuperator from specular aluminium.
- Suspension and power supply included.

Code	Description	L	Kg
92705	Slotlight U/D Louvre 1x21W+1x14W	899	2,610
92707	Slotlight U/D Louvre 1x39W+1x14W	899	2,610
92709	Slotlight U/D Louvre 1x28W+1x21W	1199	3,500
92711	Slotlight U/D Louvre 1x54W+1x21W	1199	3,500
92713	Slotlight U/D Louvre 1x35W+1x28W	1499	4,400
92715	Slotlight U/D Louvre 1x49W+1x28W	1499	4,400
92723	Slotlight U/D Louvre 2x21W+2x14W	1778	4,900
92725	Slotlight U/D Louvre 2x39W+2x14W	1778	4,900
92727	Slotlight U/D Louvre 2x28W+2x21W	2378	6,650
92729	Slotlight U/D Louvre 2x54W+2x21W	2378	6,650
92731	Slotlight U/D Louvre 2x35W+2x28W	2978	8,400
92733	Slotlight U/D Louvre 2x49W+2x28W	2978	8,400

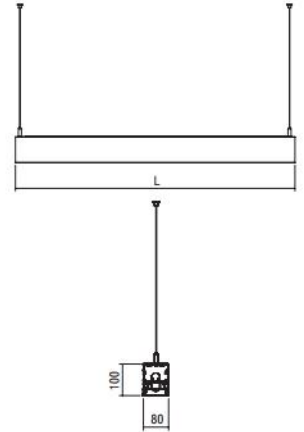

SLOTLIGHT UP / DOWN APPLIQUE



CE	F	IP 43
		Included
T16		
DESIGNED TO PHILIPS T16		

- Version for T16.
- Aluminium body.
- Removable plastic heads.
- High efficient diffuser in opal PMMA.
- Flow recuperator in white colour.

Code	Description	L	Kg
92805	Slotlight U/D Applique 1x21W+1x14W	885	2,610
92807	Slotlight U/D Applique 1x39W+1x14W	885	2,610
92809	Slotlight U/D Applique 1x28W+1x21W	1185	3,500
92811	Slotlight U/D Applique 1x54W+1x21W	1185	3,500
92813	Slotlight U/D Applique 1x35W+1x28W	1485	4,350
92815	Slotlight U/D Applique 1x49W+1x28W	1485	4,350

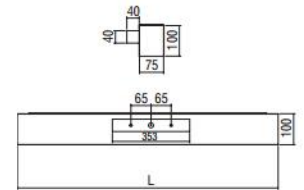

SLOTLIGHT UP / DOWN APPLIQUE LED

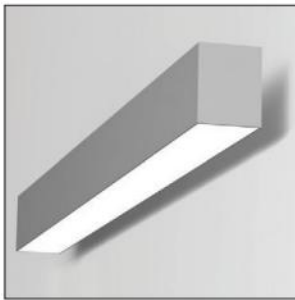

CE	F	IP 43
		Included
LED	3000lm	ta 25°C

- Version for LED CHIP.
- Aluminium body.
- Removable plastic heads.
- High efficient diffuser in opal PMMA.
- Flow recuperator in white colour.
- Efficiency: max. 138 Lumen / Watt.

Code	Description	L	Kg
92773	Slotlight U/D Ap.Led 33W+16W 4400+2200 lm Neutral	1160	3,500
92774	Slotlight U/D Ap.Led 33W+16W 4400+2200 lm Warm	1160	3,500

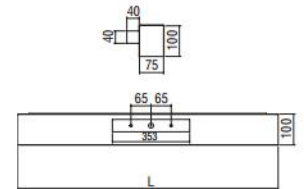

Colour Codes:

- 0 Colours 1 White 2 Titan 3 Black 5 matt Alum. 9 Anodized

SLOTLIGHT

SLOTLIGHT WW

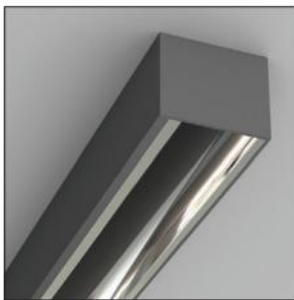

CE	F	IP 20
T16		
OSRAM TO PHILIPS T16		
		Included

- Version for T16.
- Aluminium body.
- Flow recuperator wall washer in semi-glossy anodized aluminium.
- Suspension and power supply not included.

Code	Description	L	Kg
90403	Slotlight WW 1x20/24W T16	576	2,000
90407	Slotlight WW 1x34/39W T16	876	2,300
90411	Slotlight WW 1x50/54W T16	1176	2,950
90417	Slotlight WW 1x73/80W T16	1476	3,600

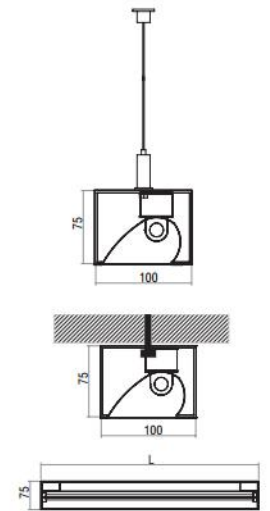

Colour Codes:

- 0 Colours 1 White 2 Titan 3 Black

SLOTLIGHT LOUVRE



CE	F	IP 20
T16		
OSRAM TO PHILIPS T16		
		Included

- Version for T16.
- Aluminium body.
- Removable plastic heads.
- Parabolic louvre in specular anodized aluminium.
- Suspension and power supply not included.

Code	Description	L	Kg
90203	Slotlight Louvre 1x20/24W T16	599	1,680
90207	Slotlight Louvre 1x34/39W T16	899	2,300
90211	Slotlight Louvre 1x50/54W T16	1199	3,150
90215	Slotlight Louvre 1x45/49W T16	1499	4,020
90217	Slotlight Louvre 1x73/80W T16	1499	4,020
90221	Slotlight Louvre 1+1x20/24W T16	1178	2,760
90225	Slotlight Louvre 1+1x34/39W T16	1778	2,950
90229	Slotlight Louvre 1+1x50/54W T16	2378	4,700
90233	Slotlight Louvre 1+1x45/49W T16	2978	5,130
90235	Slotlight Louvre 1+1x73/80W T16	2978	5,130

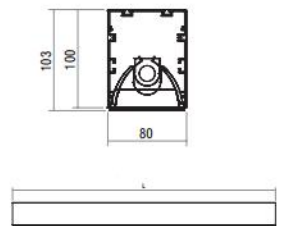

Colour Codes:

- 0 Colours 1 White 2 Titan 3 Black 5 matt Alum. 9 Anodized





SLOTLIGHT

SLOTLIGHT + Module 50 G5.3

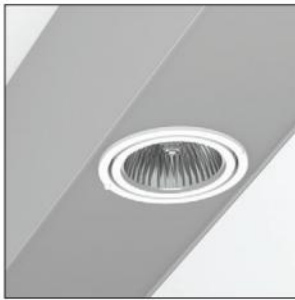

CE F 850°C IP 20

25° 350°

12V

- Simple version for incandescent halogen max.50W 12V (QR-CBC 51).

Code	Description	L	Kg
90704	Slotlight Module 50 1x max.50W/G5,3	300	0,850
90705	Slotlight Module 50 2x max.50W/G5,3	450	1,270

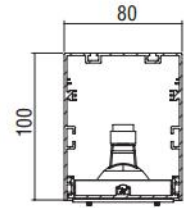

SLOTLIGHT + Module 50 GU10

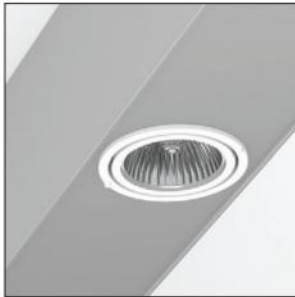

CE F 850°C IP 20

30° 350°

PAR 16 LED FLUO

- Simple version for incandescent halogen max.50W 230V (PAR16).

Code	Description	L	Kg
90701	Slotlight Module 50 1x max.50W/GU10	170	0,450
90702	Slotlight Module 50 2x max.50W/GU10	250	0,620

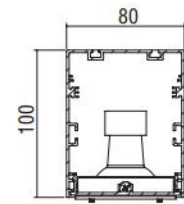

SLOTLIGHT + Module 50 IRA 2 Reflector

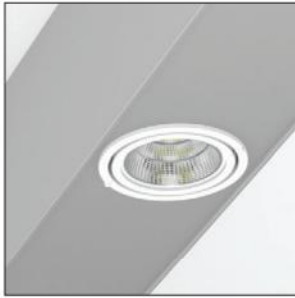

CE F 850°C IP 20

25° 350°

LED ta 25°C 350mA

- Reflectors: Medium, Wide.  
 - 7W power consumption driven at 350mA.  
 - Efficiency:  
 4000 K: 770 Lumen, CRI: min. 80  
 3000 K: 730 Lumen, CRI: min. 80  
 Maximum: 110 Lm/W

Code	Description	L	Kg
90707	Slotlight Module 50 1x IRA 2 7W Reflector	300	0,850
90708	Slotlight Module 50 2x IRA 2 7W Reflector	450	1,270

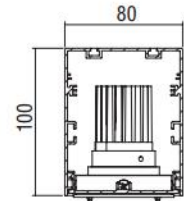

SLOTLIGHT + Module 50 DIMITRA 2 Reflector HO

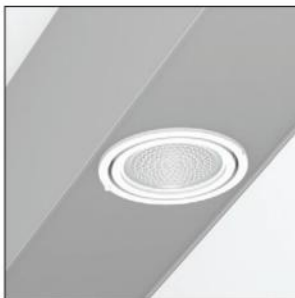

CE F 850°C IP 40

25° 350°

LED ta 25°C 500mA

- Reflectors: Spot, Medium, Wide.  
 - 5W power consumption driven at 500mA.  
 - Efficiency:  
 5W: 4000 K: 510 Lumen, CRI: min. 80  
 5W: 3000 K: 485 Lumen, CRI: min. 80  
 Maximum: 102 Lm/W

Code	Description	L	Kg
90709	Slotlight Module 50 1x DIMITRA 2 5W Ref.HO	300	0,850
90710	Slotlight Module 50 2x DIMITRA 2 5W Ref.HO	450	1,270

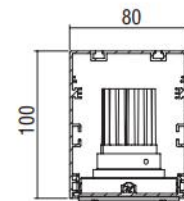

SLOTLIGHT + Module 50 ARTEMIS 2 Diffuser Prismatic



CE F 850°C IP 40

25° 350°

D LED ta 25°C 350/500mA

- Beam: Diffuser.  
 - 5W power consumption driven at 500mA.  
 - 7W power consumption driven at 350mA.  
 - Efficiency:  
 5W: 4000 K: 510 Lumen, CRI: min. 80  
 5W: 3000 K: 485 Lumen, CRI: min. 80  
 7W: 4000 K: 770 Lumen, CRI: min. 80  
 7W: 3000 K: 730 Lumen, CRI: min. 80  
 Maximum: 110 Lm/W

Code	Description	L	Kg
90711	Slotlight Module 50 1x ARTEMIS 2 5W Diffuser Prism.	300	0,850
90712	Slotlight Module 50 2x ARTEMIS 2 5W Diffuser Prism.	450	1,170
90713	Slotlight Module 50 1x ARTEMIS 2 7W Diffuser Prism.	300	0,850
90714	Slotlight Module 50 2x ARTEMIS 2 7W Diffuser Prism.	450	1,270

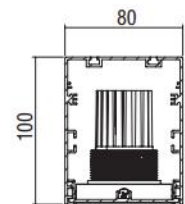

SLOTLIGHT

SLOTLIGHT + Module 50 ATHINA 2 Diffuser Opal



CE	F	850°C	IP 40
20°	350°		
D			
LED	350/500mA	ta 25°C	Included

- Beam: Diffuser.
- 5W power consumption driven at 500mA.
- 7W power consumption driven at 350mA.
- Efficiency:
- 5W: 4000 K: 510 Lumen, CRI: min. 80
- 5W: 3000 K: 485 Lumen, CRI: min. 80
- 7W: 4000 K: 770 Lumen, CRI: min. 80
- 7W: 3000 K: 730 Lumen, CRI: min. 80
- Maximum: 110 Lm/W

Code	Description	L	Kg
90715 00	Slotlight Module 50 1x ATHINA 2 5W Diffuser Opal	300	0,770
90716 00	Slotlight Module 50 2x ATHINA 2 5W Diffuser Opal	450	1,160
90717 00	Slotlight Module 50 1x ATHINA 2 7W Diffuser Opal	300	0,770
90718 00	Slotlight Module 50 2x ATHINA 2 7W Diffuser Opal	450	1,160

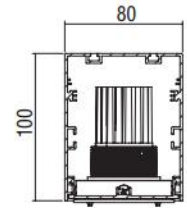

SLOTLIGHT + Module 50 VENUS 2 Lens



CE	F	850°C	IP 40
25°	350°		
LED	350/700mA	ta 25°C	Included

- Lens: Spot, Medium, Wide.
- 3W power consumption driven at 350mA.
- 6W power consumption driven at 700mA.
- Efficiency:
- 3W: 4000 K: 321 Lumen, CRI: min. 75
- 3W: 3000 K: 300 Lumen, CRI: min. 80
- 6W: 4000 K: 600 Lumen, CRI: min. 75
- 6W: 3000 K: 570 Lumen, CRI: min. 80
- Maximum: 107 Lm/W

Code	Description	L	Kg
90719	Slotlight Module 50 1x VENUS 2 3W/6W Lens	300	0,770
90720	Slotlight Module 50 2x VENUS 2 3W/6W Lens	450	1,160

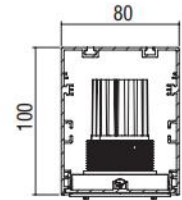

SLOTLIGHT + Module 30



CE	F		IP 20
0°			
LED	Included	ta 25°C	Included

- Version for LED CHIP.
- Aluminium body.
- Lens in Spot, Medium, Wide or spot reflector selection.

Code	Description	L	Kg
90721	Slotlight Module 30 1x2W Lens	240	0,680
90722	Slotlight Module 30 2x2W Lens	320	0,820
90723	Slotlight Module 30 3x2W Lens	400	1,070
90724 01	Slotlight Module 30 1x2W Reflector	240	0,670
90725 01	Slotlight Module 30 2x2W Reflector	320	0,880
90726 01	Slotlight Module 30 3x2W Reflector	400	1,100

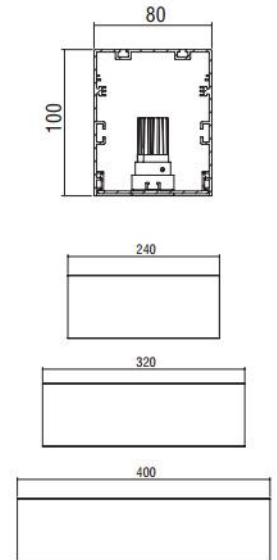

**LED COLOUR CODES:**  
2 Warm 3 Neutral

**BEAM CODES:**  
01 spot 02 medium 03 wide

**Colour Codes:**  
0 Colours 1 White 2 Titan 3 Black 5 matt Alum. 9 Anodized

SLOTLIGHT ACCESSORIES

POWER SUPPLY



CE

- For pendant use.
- Plastic body.
- With transparent cable 3x0,75mm<sup>2</sup>.
- Round version.

Code	Description	L	Kg
900121	Power Supply with Rosette Ø75	500	0,060
900122	Power Supply with Rosette Ø75	1000	0,120
900123	Power Supply with Rosette Ø75	1500	0,180
900124	Power Supply with Rosette Ø75	2000	0,240
900126	Power Supply with Rosette Ø75	3000	0,360

POWER SUPPLY



CE

- For pendant use.
- Body from aluminium profile.
- With 2m transparent cable 3x0,75mm<sup>2</sup>.
- Square or round version.

Code	Description	Kg
90042	Power Supply L 2m with Rosette Ø80	0,130
90043	Power Supply L 2m with Rosette Ø70	0,130
90044	Power Supply L 2m with Rosette 80x80	0,210
90045	Power Supply L 2m with Rosette 70x70	0,200



SCONCE BASE

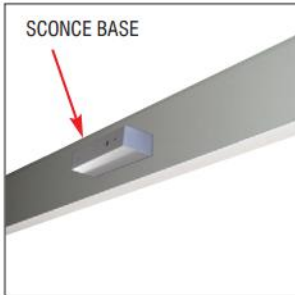

CE

- For one way applique version.
- Body from aluminium profile.
- **Required:**  
1 base for length <or = 1650mm &  
2 bases for length > 1650mm

Code	Description	Kg
90013	Sconce Base	0,160

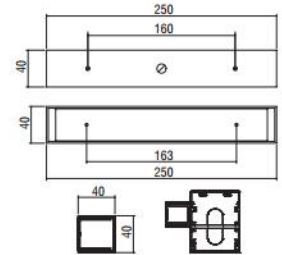

SURFACE SCONCE BASE



CE

- For surface one way applique version.
- Body from aluminium profile.
- **Required:**  
1 base for length <or = 1650mm &  
2 bases for length > 1650mm

Code	Description	Kg
90046	Surface Sconce Base	0,080

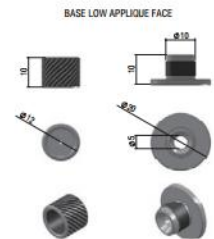

SINGLE ADJUSTABLE SUSPENSION

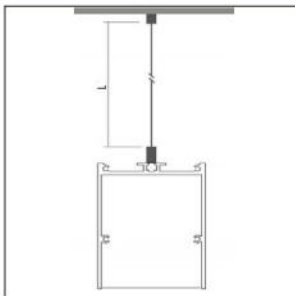

CE

- Stainless steel cable and regulators.
- **Required:**  
2 pieces for up to 3m profile.

Code	Description	L	Kg
900111	Single Suspension	500	0,050
900112	Single Suspension	1000	0,100
900113	Single Suspension	1500	0,150
900114	Single Suspension	2000	0,200
900116	Single Suspension	3000	0,300

SLOTLIGHT ACCESSORIES

SURFACE SCONCE BASE

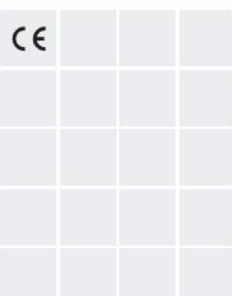
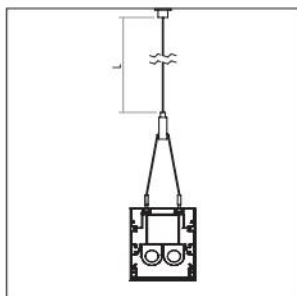

- Stainless steel cable and regulators.
- **Required:**  
2 pieces for up to 3m profile.

Code	Description	L	Kg
900142	Double Suspension	1000	0,070
900143	Double Suspension	1500	0,110
900144	Double Suspension	2000	0,220

Colour Codes:

0 Colours 1 White 2 Titan 3 Black 5 matt Alum.





## STREAMLIGHT

---

*This luminaire combines the architectural style with the efficiency. It produces perfect lighting conditions without annoying reflections and that is why it can be used from entrance areas to offices. Uniformly illuminated lines with no dark shadows can be created thanks to the Tetris technology of T16 lamps. The LED version escapes the restrictions of the T16 lamp by using LED lighting points that can have any spacing pitch and this gives the light line enormous flexibility. The visual benefit: The continuous-row system is illuminated absolutely uniformly from beginning to end, is economically efficient, is maintenance-free and it has long service life.*

### Technical Features

---

- Housing from aluminium profile, painted electrostatically in selected colour.
- Removable plastic heads.
- High efficient diffuser in opal PMMA.
- Flow recuperator in white colour.

#### Upon request

- Connection for operation with electronic dimmable ballast.

#### For LED Version

- Pure light without IR/UV radiation.
- Efficient thermal management.
- Up to 28W/m and 3864 Lm luminous flux range.
- Operation life: 50,000 hours with efficiency > 70% of the initial luminous flux.
- Connection for operation on 230V/50Hz.

#### Upon request:

Available with highest colour rendering index (CRI)

STREAMLIGHT

STREAMLIGHT TETRIS

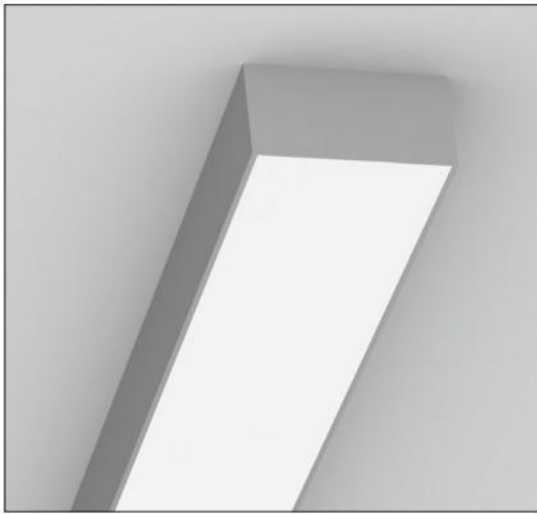

- Version for T16.
- Aluminium body.
- Removable plastic heads.
- High efficient diffuser in opal PMMA.
- Flow recuperator in white colour.
- Suspension and power supply not included.

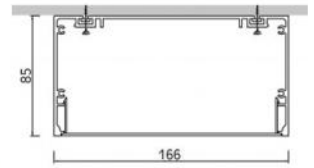

Code	Description	L	Kg
91537	Streamlight Tetris 2x13/14W T16	585	3,000
91539	Streamlight Tetris 2x20/24W T16	585	3,000
91541	Streamlight Tetris 2x19/21W T16	885	3,970
91543	Streamlight Tetris 2x34/39W T16	885	3,970
91545	Streamlight Tetris 2x25/28W T16	1185	4,270
91547	Streamlight Tetris 2x50/54W T16	1185	4,270
91549	Streamlight Tetris 2x32/35W T16	1485	5,260
91551	Streamlight Tetris 2x45/49W T16	1485	5,260
91553	Streamlight Tetris 2x73/80W T16	1485	5,260
91563	Streamlight Tetris 2+2x25/28W T16	2250	8,600
91565	Streamlight Tetris 2+2x50/54W T16	2250	8,600
91567	Streamlight Tetris 2+2x32/35W T16	2850	9,200
91569	Streamlight Tetris 2+2x45/49W T16	2850	9,200
91571	Streamlight Tetris 2+2x73/80W T16	2850	9,200

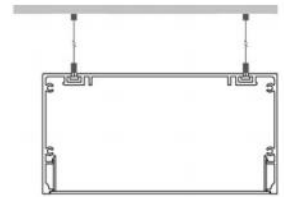

CE IP 43

T16

OSRAM: 15 PHILIPS: T16

Included

STREAMLIGHT LED



- Version for LED CHIP.
- Aluminium body.
- Removable plastic heads.
- High efficient diffuser in opal PMMA.
- Flow recuperator in white colour.
- Suspension and power supply not included.
- Efficiency: max. 138 Lumen / Watt.

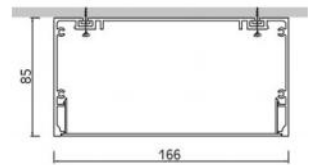

Code	Description	L	Kg
91573	Streamlight Led 16W 2200 lm Neutral	600	3,200
91574	Streamlight Led 33W 4400 lm Neutral	1160	4,270
91575	Streamlight Led 49W 6600 lm Neutral	1720	5,970
91576	Streamlight Led 65W 8800 lm Neutral	2280	8,600
91577	Streamlight Led 16W 2200 lm Warm	600	3,200
91578	Streamlight Led 33W 4400 lm Warm	1160	4,270
91579	Streamlight Led 49W 6600 lm Warm	1720	5,970
91580	Streamlight Led 65W 8800 lm Warm	2280	8,600

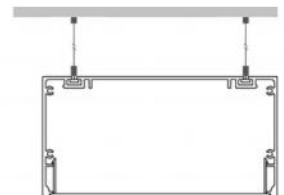

CE IP 43

LED ta 25°C

Included

Colour Codes:

- 0 Colours 1 White 2 Titan 3 Black 5 matt Alum. 9 Anodized

STREAMLIGHT

STREAMLIGHT ANAGLYPH

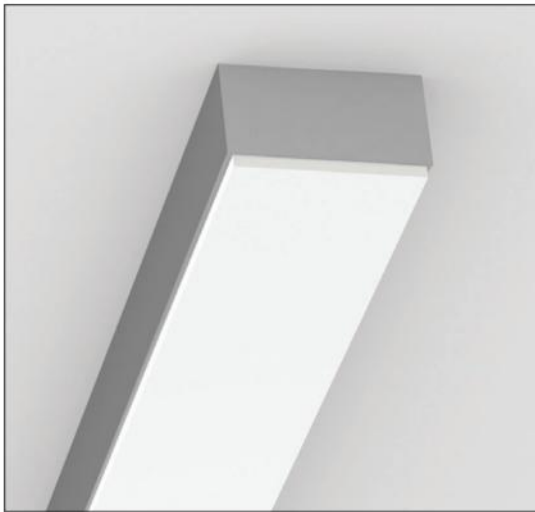

- Version for T16.
- Aluminium body.
- Removable plastic heads.
- High efficient diffuser in opal PMMA.
- Flow recuperator in white colour.
- Suspension and power supply not included.

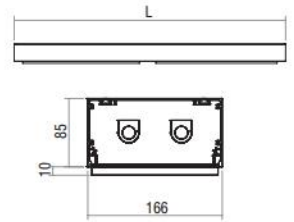

Code	Description	L	Kg
91737	Streamlight Anaglyph 2x13/14W T16	585	3,300
91739	Streamlight Anaglyph 2x20/24W T16	585	3,300
91741	Streamlight Anaglyph 2x19/21W T16	885	5,000
91743	Streamlight Anaglyph 2x34/39W T16	885	5,000
91745	Streamlight Anaglyph 2x25/28W T16	1185	6,700
91747	Streamlight Anaglyph 2x50/54W T16	1185	6,700
91749	Streamlight Anaglyph 2x32/35W T16	1485	8,400
91751	Streamlight Anaglyph 2x45/49W T16	1485	8,400
91753	Streamlight Anaglyph 2x73/80W T16	1485	8,400
91763	Streamlight Anaglyph 2+2x28/28W T16	2250	12,750
91765	Streamlight Anaglyph 2+2x50/54W T16	2250	12,750
91767	Streamlight Anaglyph 2+2x32/35W T16	2850	16,100
91769	Streamlight Anaglyph 2+2x45/49W T16	2850	16,100
91771	Streamlight Anaglyph 2+2x73/80W T16	2850	16,100

CE F IP 43

T16

OPRAN: T5 PHILIPS: T5

Included

STREAMLIGHT ANAGLYPH LED



- Version for LED CHIP.
- Aluminium body.
- Removable plastic heads.
- High efficient diffuser in opal PMMA.
- Flow recuperator in white colour.
- Suspension and power supply not included.
- Efficiency: max.138 Lumen / Watt.

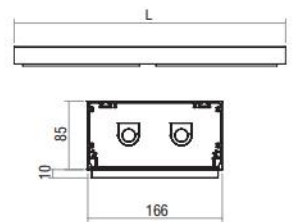

Code	Description	L	Kg
91773	Streamlight An.Led 16W 2200 lm Neutral	600	3,400
91774	Streamlight An.Led 33W 4400 lm Neutral	1160	6,560
91775	Streamlight An.Led 49W 6600 lm Neutral	1720	9,700
91776	Streamlight An.Led 65W 8800 lm Neutral	2280	12,900
91777	Streamlight An.Led 16W 2200 lm Warm	600	3,400
91778	Streamlight An.Led 33W 4400 lm Warm	1160	6,560
91779	Streamlight An.Led 49W 6600 lm Warm	1720	9,700
91780	Streamlight An.Led 65W 8800 lm Warm	2280	12,900

CE F IP 43

LED

ta 25°C

Included

Colour Codes:

0	Colours	1	White	2	Titan	3	Black	5	matt Alum.	9	Anodized
---	---------	---	-------	---	-------	---	-------	---	------------	---	----------



STREAMLIGHT

STREAMLIGHT PLEXI OPAL CARRE

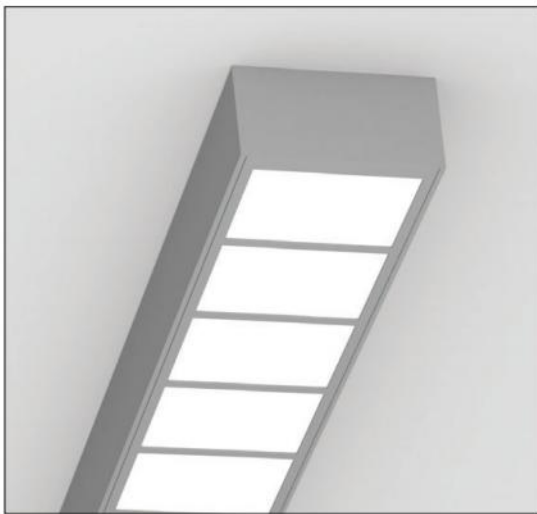

- Version for T16.
- Aluminium body.
- Removable plastic heads.
- High efficient diffuser in opal PMMA.
- Flow recuperator in white colour.
- Suspension and power supply not included.

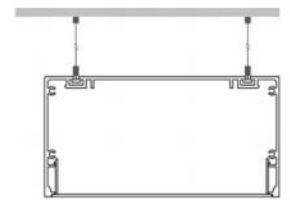
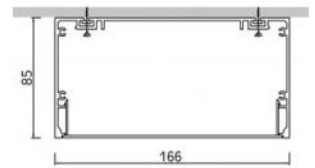

Code	Description	L	Kg
91237	Streamlight Plexi Opal Carré 2x13/14W T16	585	3,000
91239	Streamlight Plexi Opal Carré 2x20/24W T16	585	3,000
91241	Streamlight Plexi Opal Carré 2x19/21W T16	885	4,550
91243	Streamlight Plexi Opal Carré 2x34/39W T16	885	4,550
91245	Streamlight Plexi Opal Carré 2x25/28W T16	1185	6,100
91247	Streamlight Plexi Opal Carré 2x50/54W T16	1185	6,100
91249	Streamlight Plexi Opal Carré 2x32/35W T16	1485	7,600
91251	Streamlight Plexi Opal Carré 2x45/49W T16	1485	7,600
91253	Streamlight Plexi Opal Carré 2x73/80W T16	1485	7,600
91263	Streamlight Plexi Opal Carré 2+2x25/28W T16	2250	11,550
91265	Streamlight Plexi Opal Carré 2+2x50/54W T16	2250	11,550
91267	Streamlight Plexi Opal Carré 2+2x32/35W T16	2850	14,600
91269	Streamlight Plexi Opal Carré 2+2x45/49W T16	2850	14,600
91271	Streamlight Plexi Opal Carré 2+2x73/80W T16	2850	14,600

CE IP 43

T16

OSRAM: 15 PHILIPS: T16

Included

STREAMLIGHT PLEXI OPAL CARRE LED



- Version for LED CHIP.
- Aluminium body.
- Removable plastic heads.
- High efficient diffuser in opal PMMA.
- Flow recuperator in white colour.
- Suspension and power supply not included.
- Efficiency: max. 138 Lumen / Watt.

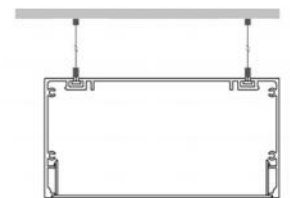
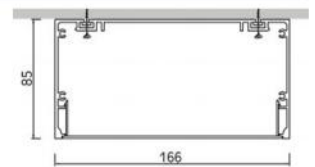

Code	Description	L	Kg
91273	Streamlight Plexi Opal Carré Led 16W 2200 lm Neutral	600	3,080
91274	Streamlight Plexi Opal Carré Led 33W 4400 lm Neutral	1160	5,940
91275	Streamlight Plexi Opal Carré Led 49W 6600 lm Neutral	1720	8,810
91276	Streamlight Plexi Opal Carré Led 65W 8800 lm Neutral	2280	11,680
91277	Streamlight Plexi Opal Carré Led 16W 2200 lm Warm	600	3,080
91278	Streamlight Plexi Opal Carré Led 33W 4400 lm Warm	1160	5,940
91279	Streamlight Plexi Opal Carré Led 49W 6600 lm Warm	1720	8,810
91280	Streamlight Plexi Opal Carré Led 65W 8800 lm Warm	2280	11,680

CE IP 43

LED ta 25°C

Included

Colour Codes:

0	Colours	1	White	2	Titan	3	Black	5	matt Alum.	9	Anodized
---	---------	---	-------	---	-------	---	-------	---	------------	---	----------

STREAMLIGHT

STREAMLIGHT PLEXI OPAL DOUBLE

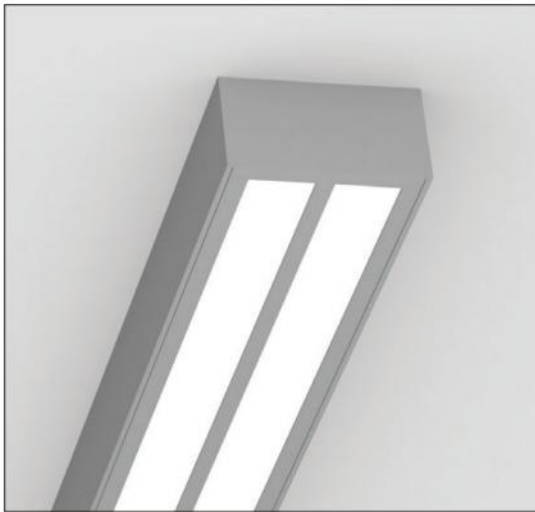

- Version for T16.
- Aluminium body.
- Removable plastic heads.
- High efficient diffuser in opal PMMA.
- Flow recuperator in white colour.
- Suspension and power supply not included.

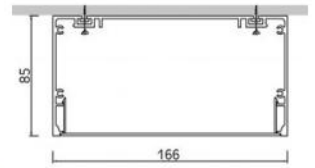

Code	Description	L	Kg
91337	Streamlight Plexi Opal Double 2x13/14W T16	585	3,000
91339	Streamlight Plexi Opal Double 2x20/24W T16	585	3,000
91341	Streamlight Plexi Opal Double 2x19/21W T16	885	4,550
91343	Streamlight Plexi Opal Double 2x34/39W T16	885	4,550
91345	Streamlight Plexi Opal Double 2x25/28W T16	1185	6,100
91347	Streamlight Plexi Opal Double 2x50/54W T16	1185	6,100
91349	Streamlight Plexi Opal Double 2x32/35W T16	1485	7,600
91351	Streamlight Plexi Opal Double 2x45/49W T16	1485	7,600
91353	Streamlight Plexi Opal Double 2x73/80W T16	1485	7,600
91363	Streamlight Plexi Opal Double 2+2x25/28W T16	2250	11,550
91365	Streamlight Plexi Opal Double 2+2x50/54W T16	2250	11,550
91367	Streamlight Plexi Opal Double 2+2x32/35W T16	2850	11,550
91369	Streamlight Plexi Opal Double 2+2x45/49W T16	2850	11,550
91371	Streamlight Plexi Opal Double 2+2x73/80W T16	2850	11,550

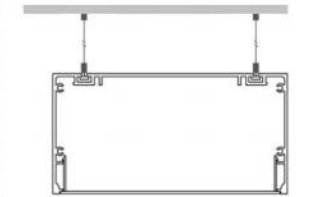

CE F IP 43

T16

OPAL: 10  
PLEXI: 1,5

Included

STREAMLIGHT PLEXI OPAL DOUBLE LED

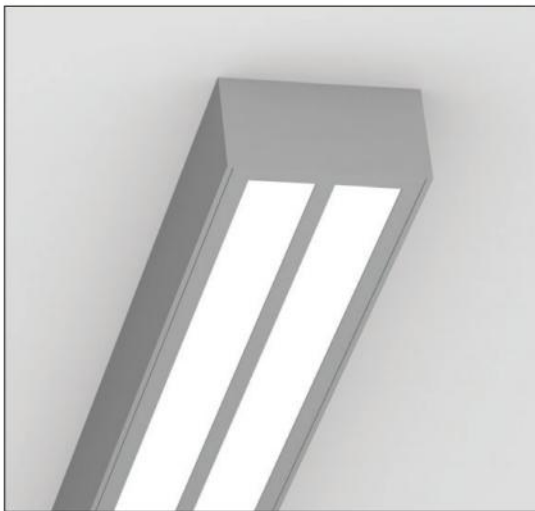

- Version for LED CHIP.
- Aluminium body.
- Removable plastic heads.
- High efficient diffuser in opal PMMA.
- Flow recuperator in white colour.
- Suspension and power supply not included.
- Efficiency: max.138 Lumen / Watt.

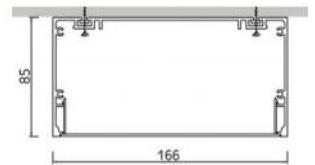

Code	Description	L	Kg
91373	Streamlight Plexi Opal Double Led 16W 2200 lm Neutral	600	3,080
91374	Streamlight Plexi Opal Double Led 33W 4400 lm Neutral	1160	5,940
91375	Streamlight Plexi Opal Double Led 49W 6600 lm Neutral	1720	8,810
91376	Streamlight Plexi Opal Double Led 65W 8800 lm Neutral	2280	11,680
91377	Streamlight Plexi Opal Double Led 16W 2200 lm Warm	600	3,080
91378	Streamlight Plexi Opal Double Led 33W 4400 lm Warm	1160	5,940
91379	Streamlight Plexi Opal Double Led 49W 6600 lm Warm	1720	8,810
91380	Streamlight Plexi Opal Double Led 65W 8800 lm Warm	2280	11,680

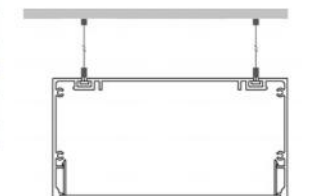

CE F IP 43

LED

ta 25°C

Included

Colour Codes:

- 0 Colours 1 White 2 Titan 3 Black 5 matt Alum. 9 Anodized

STREAMLIGHT

STREAMLIGHT WW

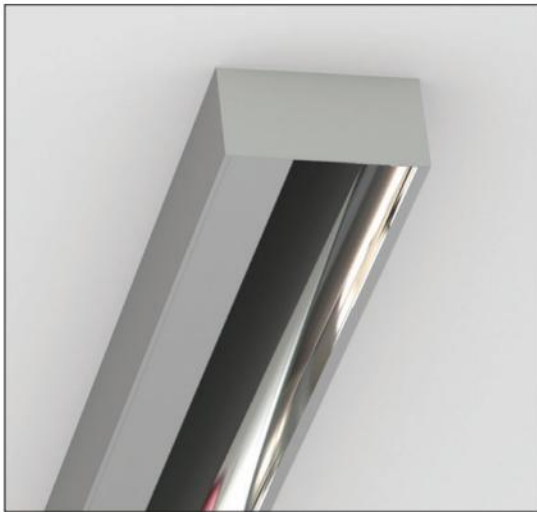

- Version for T16.
- Aluminium body.
- Removable plastic heads.
- Flow recuperator wall washer in semi-glossy anodized aluminium.
- Suspension and power supply not included.

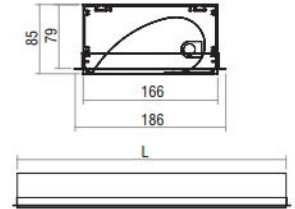

Code	Description	L	Kg
91803	Streamlight WW 1x20/24W T16	580	3,080
91807	Streamlight WW 1x34/39W T16	880	4,510
91811	Streamlight WW 1x50/54W T16	1180	6,050
91817	Streamlight WW 1x73/80W T16	1480	7,580

CE IP 20

T16

OSRAM TS PHILIPS T16

Included

Colour Codes:

0 Colours 1 White 2 Titan 3 Black

STREAMLIGHT LOUVRE

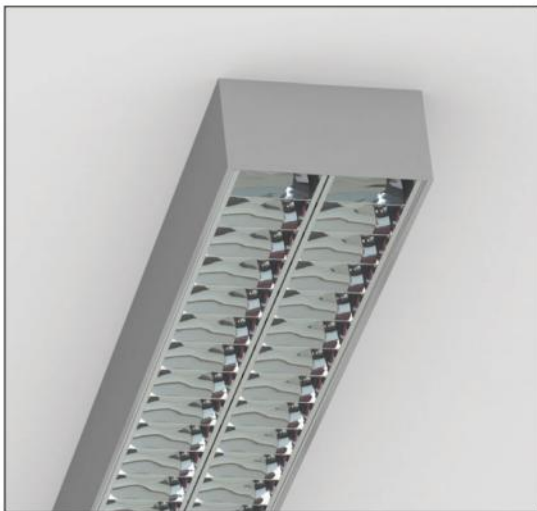

- Version for T16.
- Aluminium body.
- Removable plastic heads.
- Parabolic reflector in specular anodized aluminium.
- Suspension and power supply not included.

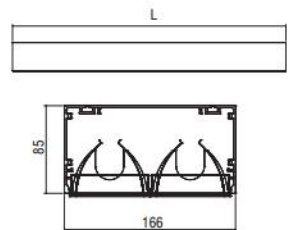

Code	Description	L	Kg
91937	Streamlight Louvre 2x13/14W T16	599	2,100
91939	Streamlight Louvre 2x20/24W T16	599	2,100
91941	Streamlight Louvre 2x19/21W T16	899	3,180
91943	Streamlight Louvre 2x34/39W T16	899	3,180
91945	Streamlight Louvre 2x25/28W T16	1199	4,270
91947	Streamlight Louvre 2x50/54W T16	1199	4,270
91949	Streamlight Louvre 2x32/35W T16	1499	5,350
91951	Streamlight Louvre 2x45/49W T16	1499	5,350
91953	Streamlight Louvre 2x73/80W T16	1499	5,350
91963	Streamlight Louvre 2+2x25/28W T16	2378	8,100
91965	Streamlight Louvre 2+2x50/54W T16	2378	8,100
91967	Streamlight Louvre 2+2x32/35W T16	2978	10,260
91969	Streamlight Louvre 2+2x45/49W T16	2978	10,260
91971	Streamlight Louvre 2+2x73/80W T16	2978	10,260

CE IP 20

T16

OSRAM TS PHILIPS T16

Included

Colour Codes:

0 Colours 1 White 2 Titan 3 Black 5 matt Alum. 9 Anodized

STREAMLIGHT

STREAMLIGHT + Module 60 POSIDON HI-PAR 111

Module 60 POSIDON HI-PAR 111



CE	F	850°C	IP 20
70°	350°		
POSIDON HI-PAR 111 PAR 111 GX8.5			Included

- Version for HI-PAR 111/GX8.5.
- Outer adjustable ring from die-cast aluminium.

Code	Description	L	Kg
91615	Streamlight Module 60 POSIDON 35W HI-PAR 111/GX8.5	350	1,580
91616	Streamlight Module 60 POSIDON 70W HI-PAR 111/GX8.5	350	1,580

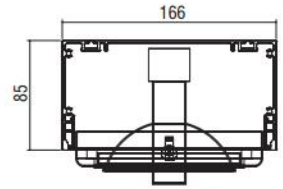

STREAMLIGHT + Module 60 DIONISOS QR111

Module 60 DIONISOS QR111



CE	F	850°C	IP 20
70°	350°		
DIONISOS QR111 PAR 111 GX53			Included

- Version for QR111/G53.
- Outer adjustable ring from die-cast aluminium.

Code	Description	L	Kg
91617	Streamlight Module 60 DIONISOS max. 70W QR111/G53	350	1,580

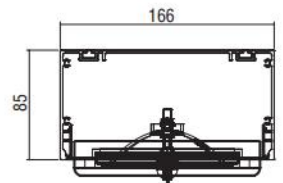

STREAMLIGHT + Module 60 ARIS LED R111

Module 60 ARIS LED R111



CE	F	850°C	IP 20
70°	350°		
ARIS LED R111 GU10			Included
LED			

- Version for LED R111/GU10.
- Outer adjustable ring from die-cast aluminium.
- Connection for 230V/50Hz.

Code	Description	L	Kg
91618	Streamlight Module 60 ARIS Led R111/GU10/230V	350	1,580

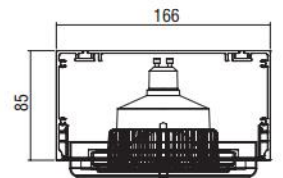

Colour Codes:

0 Colours 1 White 2 Titan 3 Black 5 matt Alum. 9 Anodized

STREAMLIGHT ACCESSORIES

POWER SUPPLY



CE

- For pendant use.
- Plastic body.
- With transparent cable 3x0,75mm<sup>2</sup>.
- Round version.

Code	Description	L	Kg
900121	Power Supply with Rosette Ø75	500	0,060
900122	Power Supply with Rosette Ø75	1000	0,120
900123	Power Supply with Rosette Ø75	1500	0,180
900124	Power Supply with Rosette Ø75	2000	0,240
900126	Power Supply with Rosette Ø75	3000	0,360

DOUBLE ADJUSTABLE SUSPENSION

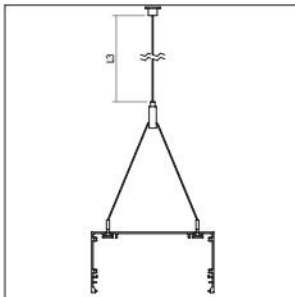

CE

- Stainless steel cable and regulators.
- **Required:**  
2 pieces for up to 3m profile.

Code	Description	L	Kg
900612	Double Suspension Streamlight	1000	0,070
900613	Double Suspension Streamlight	1500	0,110
900614	Double Suspension Streamlight	2000	0,220
900616	Double Suspension Streamlight	3000	0,290

POWER SUPPLY



CE

- For pendant use.
- Body from aluminium profile.
- With 2m transparent cable 3x0,75mm<sup>2</sup>.
- Square or round version.

Code	Description	Kg
90042	Power Supply L 2m with Rosette Ø80	0,130
90043	Power Supply L 2m with Rosette Ø70	0,130
90044	Power Supply L 2m with Rosette 80x80	0,210
90045	Power Supply L 2m with Rosette 70x70	0,200



Colour Codes:

0 Colours 1 White 2 Titan 3 Black 5 matt Alum.

## OMICRON

*A linear suspended luminaire with impressive design.  
The luminaire unit is made of an opal diffuser  
and raises the architectural interest  
because it appears almost immaterial.  
It is ideal for applications where diffuse lighting  
must be combined an elegant shape.*

**Technical Features**

- Housing from aluminium profile, painted electrostatically in white colour.
- High efficient diffuser from methacrylate PMMA.
- Removable plastic heads painted in white colour.
- Flow recuperator in white colour.

**Upon request**

- Connection for operation with electronic dimmable ballast.

**PROFILES**

**PENDANT**

**OMICRON** Ø 150mm

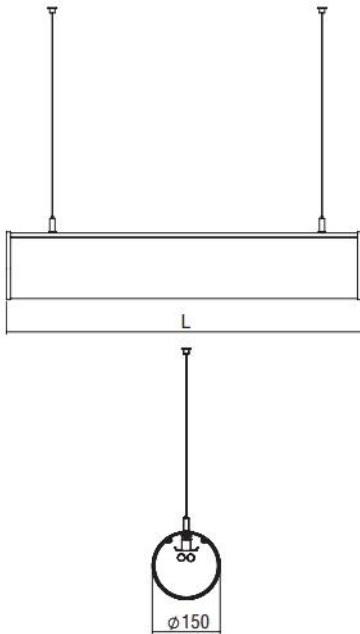
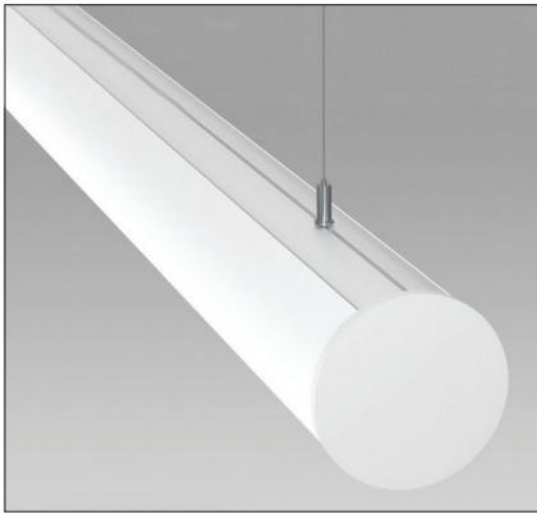

- Version for T16 and T16 SEAMLESS.
- Aluminium body.
- Removable plastic heads.
- High efficient diffuser in opal PMMA.
- Flow recuperator in white colour.
- Suspension and power supply not included.

Code	Description	L	Kg
828011	Omicron 1x13/14W T16	605	1,300
828021	Omicron 1x20/24W T16	605	1,300
828031	Omicron 1x19/21W T16	905	1,950
828041	Omicron 1x34/39W T16	905	1,950
828051	Omicron 1x25/28W T16	1205	2,580
828061	Omicron 1x50/54W T16	1205	2,580
828071	Omicron 1x32/35W T16	1505	3,600
828081	Omicron 1x45/49W T16	1505	3,600
828101	Omicron 2x13/14W T16	605	1,300
828111	Omicron 2x20/24W T16	605	1,300
828121	Omicron 2x19/21W T16	905	1,950
828131	Omicron 2x34/39W T16	905	1,950
828141	Omicron 2x25/28W T16	1205	2,560
828151	Omicron 2x50/54W T16	1205	2,560
828161	Omicron 2x32/35W T16	1505	3,220
828171	Omicron 2x45/49W T16	1505	3,220
828191	Omicron 1x14W SLS	605	1,300
828201	Omicron 1x24W SLS	605	1,300
828211	Omicron 1x21W SLS	905	1,950
828221	Omicron 1x39W SLS	905	1,950
828231	Omicron 1x28W SLS	1205	2,560
828241	Omicron 1x54W SLS	1205	2,560
828281	Omicron 2x14W SLS	605	1,300
828291	Omicron 2x24W SLS	605	1,300
828301	Omicron 2x21W SLS	905	1,950
828311	Omicron 2x39W SLS	905	1,950
828321	Omicron 2x28W SLS	1205	2,560
828331	Omicron 2x54W SLS	1205	2,560
828371	Omicron 1 + 1x19/21W T16	1740	3,730
828381	Omicron 1 + 1x34/39W T16	1740	3,730
828391	Omicron 1 + 1x25/28W T16	2340	5,010
828401	Omicron 1 + 1x50/54W T16	2340	5,010
828411	Omicron 1 + 1x32/35W T16	2940	6,300
828421	Omicron 1 + 1x45/49W T16	2940	6,300
828441	Omicron 1 + 1x19/21W SLS	1800	3,860
828451	Omicron 1 + 1x34/39W SLS	1800	3,860
828461	Omicron 1 + 1x25/28W SLS	2400	5,150
828471	Omicron 1 + 1x50/54W SLS	2400	5,150
828511	Omicron 2 + 2x19/21W SLS	1800	3,860
828521	Omicron 2 + 2x34/39W SLS	1800	3,860
828531	Omicron 2 + 2x25/28W SLS	2400	5,150
828541	Omicron 2 + 2x50/54W SLS	2400	5,150

CE	F	IP 40
T16	SEAMLESS	
SEAMLESS	SEAMLESS	
		Included

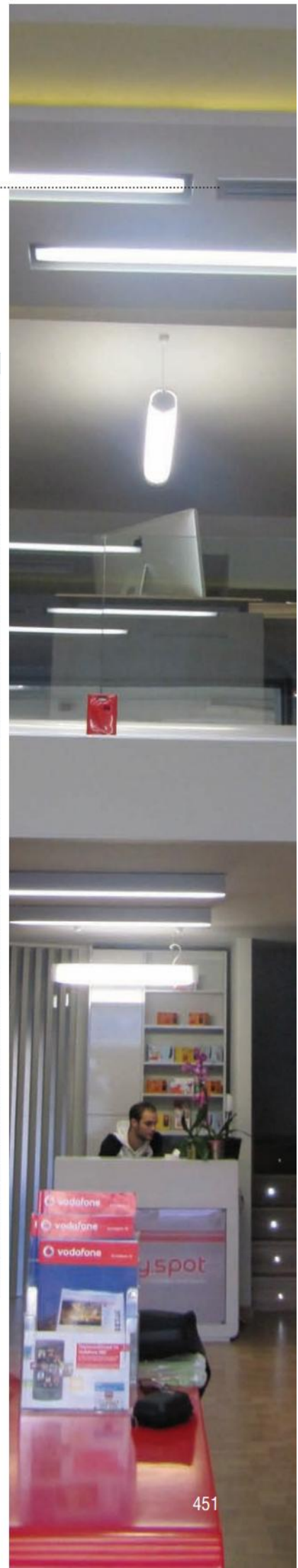

OMICRON ACCESSORIES

POWER SUPPLY

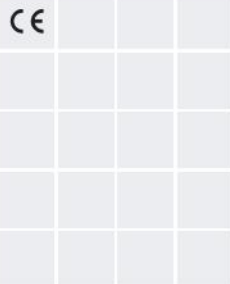

- For pendant use.
- Plastic body.
- With transparent cable 3x0,75mm<sup>2</sup>.
- Round version.

Code	Description	L	Kg
900121	Power Supply with Rosette Ø75	500	0,060
900122	Power Supply with Rosette Ø75	1000	0,120
900123	Power Supply with Rosette Ø75	1500	0,180
900124	Power Supply with Rosette Ø75	2000	0,240
900126	Power Supply with Rosette Ø75	3000	0,360

POWER SUPPLY

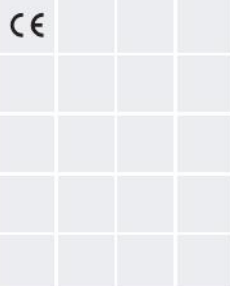

- For pendant use.
- Body from aluminium profile.
- With 2m transparent cable 3x0,75mm<sup>2</sup>.
- Square or round version.

Code	Description	Kg
90042	Power Supply L 2m with Rosette Ø80	0,130
90043	Power Supply L 2m with Rosette Ø70	0,130
90044	Power Supply L 2m with Rosette 80x80	0,210
90045	Power Supply L 2m with Rosette 70x70	0,200



SINGLE ADJUSTABLE SUSPENSION

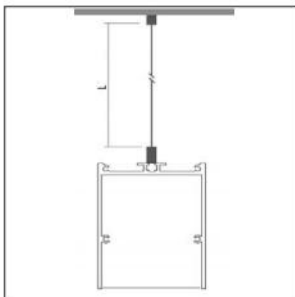

- Stainless steel cable and regulators.
- **Required:**  
2 pieces for up to 3m profile.

Code	Description	L	Kg
900111	Single Suspension	500	0,050
900112	Single Suspension	1000	0,100
900113	Single Suspension	1500	0,150
900114	Single Suspension	2000	0,200
900116	Single Suspension	3000	0,300

Colour Codes:

0 Colours 1 White 2 Titan 3 Black 5 matt Alum.





**HIGH SYSTEM / LOW SYSTEM**

---



*This luminaire combines the architectural style with the efficiency. It produces perfect lighting conditions without annoying reflections and that is why it can be used from entrance areas to offices. Uniformly illuminated lines with no dark shadows can be created thanks to the Seamless version of T16 lamps. The LED version escapes the restrictions of the T16 lamp by using LED lighting points that can have any spacing pitch and this gives the light line enormous flexibility. The visual benefit: The continuous-row system is illuminated absolutely uniformly from beginning to end, is economically efficient, is maintenance-free and it has long service life.*

**Technical Features**

---

- Housing from aluminium profile, painted electrostatically in selected colour.
- High efficient diffuser in opal PMMA.
- Flow recuperator in white colour.

**Upon request**

- Connection for operation with electronic dimmable ballast.
- Available in IP54 protection version.

**For LED Version**

- Pure light without IR/UV radiation.
- Efficient thermal management.
- Up to 27W/m and 3620 Lm luminous flux range.
- Operation life: 50,000 hours with efficiency > 70% of the initial luminous flux.
- Connection for operation on 230V/50Hz.

**Upon request:**

- Available with highest colour rendering index (CRI)
- Available in IP54 protection version.

HIGH SYSTEM / LOW SYSTEM

HIGH SYSTEM

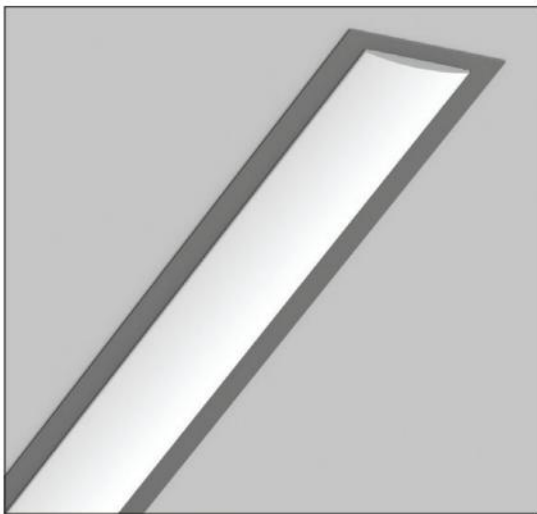

- Version for T16 and T16 SEAMLESS.
- Aluminium body.
- High efficient diffuser in opal PMMA.
- Flow recuperator in white colour.
- Suspension and power supply not included.

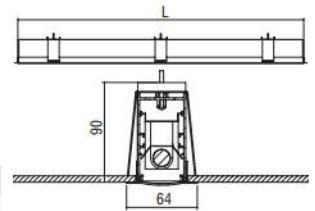

Code	Description	L	Kg
97001	High System 1x13/14W T16	615	1,070
97003	High System 1x20/24W T16	615	1,070
97005	High System 1x19/21W T16	915	1,600
97007	High System 1x34/39W T16	915	1,600
97009	High System 1x25/28W T16	1215	2,070
97011	High System 1x50/54W T16	1215	2,070
97013	High System 1x32/35W T16	1515	2,580
97015	High System 1x45/49W T16	1515	2,580
97017	High System 1x73/80W T16	1515	2,580
97037	High System 1x14W SEAMLESS	615	1,070
97039	High System 1x24W SEAMLESS	615	1,070
97041	High System 1x21W SEAMLESS	915	1,600
97043	High System 1x39W SEAMLESS	915	1,600
97045	High System 1x28W SEAMLESS	1215	2,070
97047	High System 1x54W SEAMLESS	1215	2,070
97053	High System 1 + 1x21W SEAMLESS	1805	3,600
97055	High System 1 + 1x39W SEAMLESS	1805	3,600
97057	High System 1 + 1x28W SEAMLESS	2405	4,700
97059	High System 1 + 1x54W SEAMLESS	2405	4,700

**Hole**

1x13/14W - 20/24W T16	52 x 605
1x19/21W - 34/39W T16	52 x 905
1x25/28W - 50/54W T16	52 x 1205
1x32/35W - 45/49W T16	52 x 1505
1x73/80W T16	52 x 1505
1x14 - 24W T16 SLS	52 x 605
1x21 - 39W T16 SLS	52 x 905
1x28 - 54W T16 SLS	52 x 1205
1 + 1x21W - 39W T16 SLS	52 x 1795
1 + 1x28W - 54W T16 SLS	52 x 2395

CE IP 43

T16	SEAMLESS	Included
ORDINE TO PROFILE T16	ORDINE TO PROFILE SEAMLESS	

HIGH SYSTEM LED

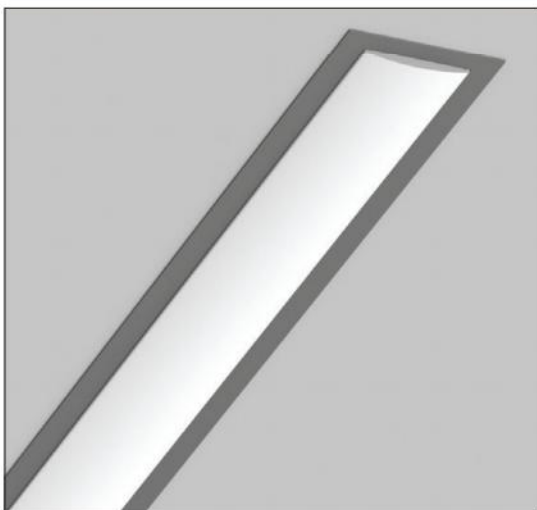

- Version for LED CHIP.
- Aluminium body.
- High efficient diffuser in opal PMMA.
- Flow recuperator in white colour.
- Suspension and power supply not included.
- Efficiency: 145 Lumen / Watt.

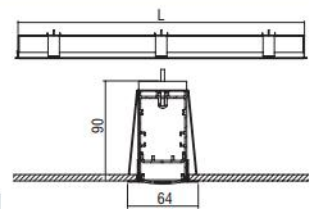

Code	Description	L	Kg
97073	High System Led 15W 2170 lm Neutral	615	1,280
97074	High System Led 23W 3260 lm Neutral	895	1,860
97075	High System Led 30W 4340 lm Neutral	1175	2,450
97076	High System Led 38W 5430 lm Neutral	1455	3,010
97077	High System Led 15W 1990 lm Warm	615	1,280
97078	High System Led 23W 2990 lm Warm	895	1,860
97079	High System Led 30W 3980 lm Warm	1175	2,450
97080	High System Led 38W 4980 lm Warm	1455	3,010

**Hole**

15W	52 x 605
23W	52 x 885
30W	52 x 1165
38W	52 x 1445

CE IP 43

LED	ta 25°C	Included

Colour Codes:

- 0 Colours 1 White 2 Titan 3 Black 5 matt Alum.



**KRICKET**  
ART OF MAKING SHOES



HIGH SYSTEM / LOW SYSTEM

LOW SYSTEM

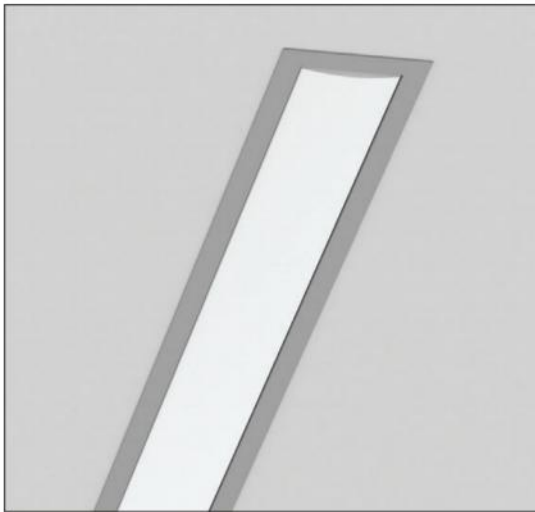

- Version for T16 and T16 SEAMLESS.
- Aluminium body.
- High efficient diffuser in opal PMMA.
- Flow recuperator in white colour.
- Suspension and power supply not included.

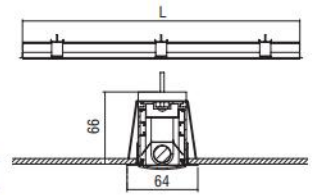

Code	Description	L	Kg
98101	Low System 1x13/14W T16	615	1,070
98103	Low System 1x20/24W T16	615	1,070
98105	Low System 1x19/21W T16	915	1,600
98107	Low System 1x34/39W T16	915	1,600
98109	Low System 1x25/28W T16	1215	2,070
98111	Low System 1x50/54W T16	1215	2,070
98113	Low System 1x32/35W T16	1515	2,580
98115	Low System 1x45/49W T16	1515	2,580
98117	Low System 1x73/80W T16	1515	2,580
98137	Low System 1x14W SEAMLESS	615	1,070
98139	Low System 1x24W SEAMLESS	615	1,070
98141	Low System 1x21W SEAMLESS	915	1,600
98143	Low System 1x39W SEAMLESS	915	1,600
98145	Low System 1x28W SEAMLESS	1215	2,070
98147	Low System 1x54W SEAMLESS	1215	2,070
98153	Low System 1+1x21W SEAMLESS	1805	4,320
98155	Low System 1+1x39W SEAMLESS	1805	4,320
98157	Low System 1+1x28W SEAMLESS	2405	5,750
98159	Low System 1+1x54W SEAMLESS	2405	5,750

**Hole**

1x13/14W - 20/24W T16	52 x 605
1x19/21W - 34/39W T16	52 x 905
1x25/28W - 50/54W T16	52 x 1205
1x32/35W - 45/49W T16	52 x 1505
1x73/80W T16	52 x 1505
1x14 - 24W T16 SLS	52 x 605
1x21 - 39W T16 SLS	52 x 905
1x28 - 54W T16 SLS	52 x 1205
1+1x21W - 39W T16 SLS	52 x 1795
1+1x28W - 54W T16 SLS	52 x 2395

CE	F	IP 43
T16	SEAMLESS	Included
OSRAM T5 PHILIPS T5	OSRAM T5 PHILIPS T5	

LOW SYSTEM LED

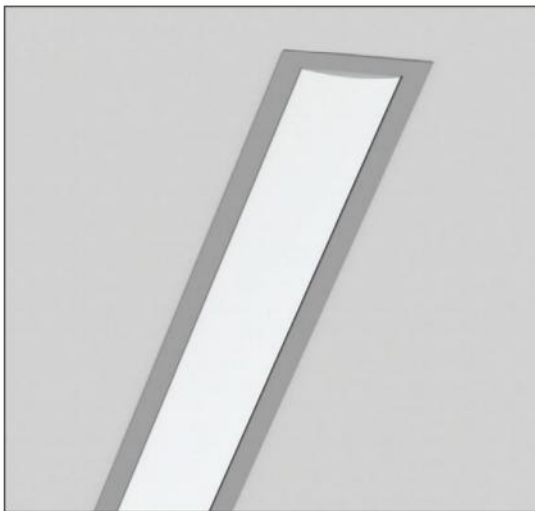

- Version for LED CHIP.
- Aluminium body.
- High efficient diffuser in opal PMMA.
- Flow recuperator in white colour.
- Suspension and power supply not included.
- Efficiency: 145 Lumen / Watt.

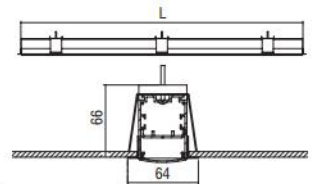

Code	Description	L	Kg
98173	Low System Led 15W 2170 lm Neutral	615	1,070
98174	Low System Led 23W 3260 lm Neutral	895	1,550
98175	Low System Led 30W 4340 lm Neutral	1175	2,040
98176	Low System Led 38W 5430 lm Neutral	1455	2,520
98177	Low System Led 15W 1990 lm Warm	615	1,070
98178	Low System Led 23W 2990 lm Warm	895	1,550
98179	Low System Led 30W 3980 lm Warm	1175	2,040
98180	Low System Led 38W 4980 lm Warm	1455	2,520

**Hole**

15W	52 x 605
23W	52 x 885
30W	52 x 1165
38W	52 x 1445

CE	F	IP 43
LED	LED	Included
LED	LED	

**Colour Codes:**

0	Colours	1	White	2	Titan	3	Black	5	matt Alum.
---	---------	---	-------	---	-------	---	-------	---	------------

HIGH SYSTEM / LOW SYSTEM

HIGH SYSTEM + Module 30

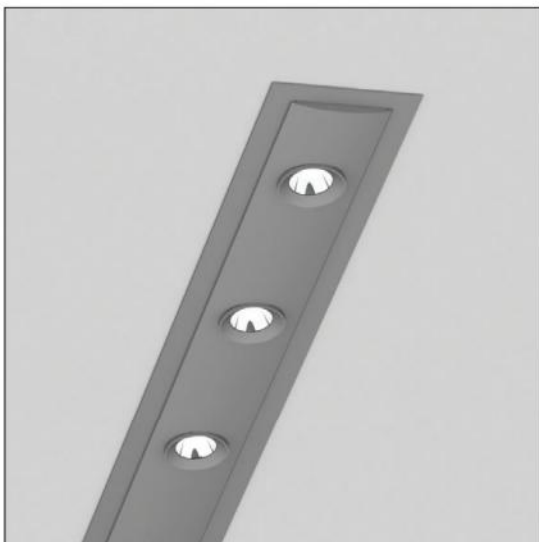
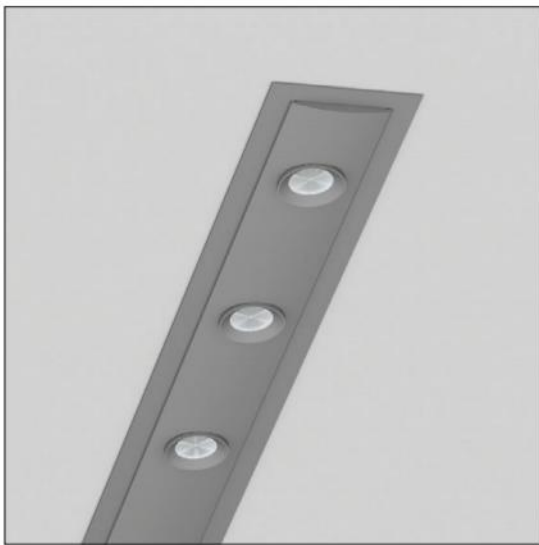

- Version for LED CHIP.
- Aluminium body.
- Lens in Spot, Medium, Wide or spot reflector selection.
- Efficiency: 107 Lumen / Watt.

Code	Description	L	Kg
97101	High System Module 30 1x2W Lens	260	0,560
97102	High System Module 30 2x2W Lens	340	0,730
97103	High System Module 30 3x2W Lens	420	0,900
97104	High System Module 30 1x2W Reflector	260	0,560
97105	High System Module 30 2x2W Reflector	340	0,730
97106	High System Module 30 3x2W Reflector	420	0,900

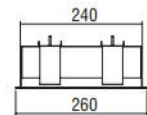
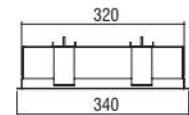
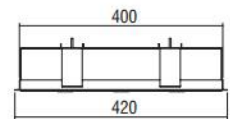
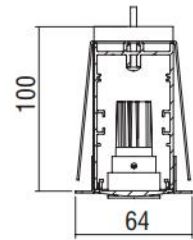

CE	△		IP 20
↻	↻		
▲	▲	▲	
LED	LED Quality	ta 25°C	Included

LED COLOUR CODES:

2 Warm 3 Neutral

BEAM CODES:

01 spot 02 medium 03 wide

Colour Codes:

0 Colours 1 White 2 Titan 3 Black 5 matt Alum.

HIGH SYSTEM / LOW SYSTEM ACCESSORIES

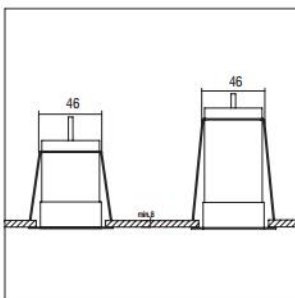

CE

- Version for LED CHIP.
- Aluminium body.
- Lens in Spot, Medium, Wide or spot reflector selection.
- Efficiency: 107 Lumen / Watt.

Code	Description	Kg
900230	Suspension Bracket High System	0,270
900240	Suspension Bracket Low System	0,270







## SLOTLIGHT

*This luminaire combines the architectural style with the efficiency. It produces perfect lighting conditions without annoying reflections and that is why it can be used from entrance areas to offices. Uniformly illuminated lines with no dark shadows can be created thanks to the Tetris technology of T16 lamps.*

*The LED version escapes the restrictions of the T16 lamp by using LED lighting points that can have any spacing pitch and this gives the light line enormous flexibility. The visual benefit: The continuous-row system is illuminated absolutely uniformly from beginning to end, is economically efficient, is maintenance-free and it has long service life.*

#### Technical Features

- Housing from aluminium profile, painted electrostatically in selected colour.
- Removable plastic heads.
- High efficient diffuser in opal PMMA.
- Flow recuperator in white colour.

#### Upon request

- Connection for operation with electronic dimmable ballast.
- Available in IP54 protection version.

#### For LED Version

- Pure light without IR/UV radiation.
- Efficient thermal management.
- Up to 28W/m and 3864 Lm luminous flux range.
- Operation life: 50,000 hours with efficiency > 70% of the initial luminous flux.
- Connection for operation on 230V/50Hz.

#### Upon request:

- Available with highest colour rendering index (CRI)
- Available in IP54 protection version.

SLOTLIGHT

SLOTLIGHT

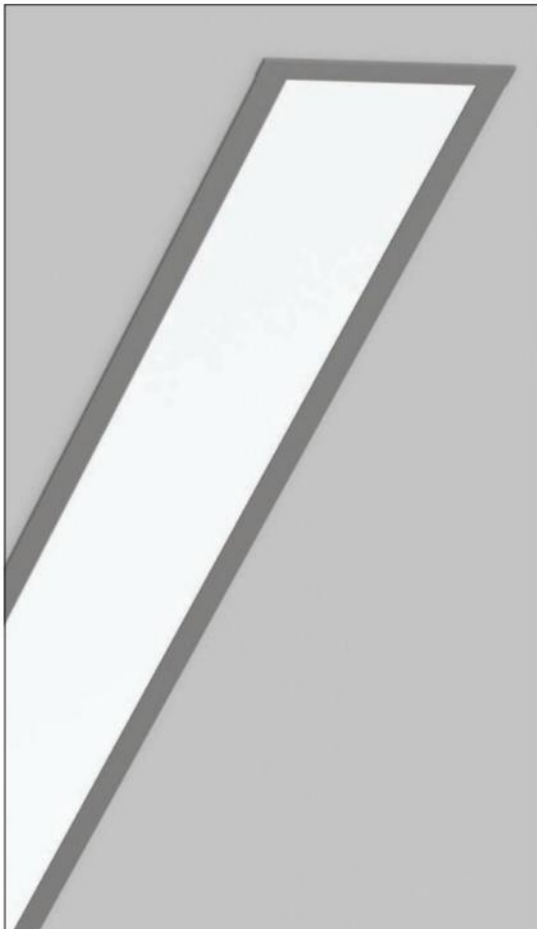

- Version for T16.
- Aluminium body.
- Removable plastic heads.
- High efficient diffuser in opal PMMA.
- Flow recuperator in white colour.
- Suspension brackets not included.

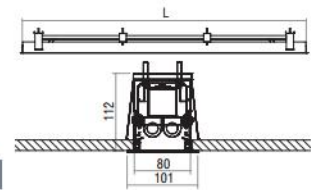

Code	Description	L	Kg
92001	Slotlight 1x13/14W T16	603	1,500
92003	Slotlight 1x20/24W T16	603	1,500
92005	Slotlight 1x19/21W T16	903	2,300
92007	Slotlight 1x34/39W T16	903	2,300
92009	Slotlight 1x25/28W T16	1203	3,050
92011	Slotlight 1x50/54W T16	1203	3,050
92013	Slotlight 1x32/35W T16	1503	3,300
92015	Slotlight 1x45/49W T16	1503	3,300
92017	Slotlight 1x73/80W T16	1503	3,300
92037	Slotlight 2x13/14W T16	603	1,650
92039	Slotlight 2x20/24W T16	603	1,650
92041	Slotlight 2x19/21W T16	903	3,000
92043	Slotlight 2x34/39W T16	903	3,000
92045	Slotlight 2x25/28W T16	1203	3,100
92047	Slotlight 2x50/54W T16	1203	3,100
92049	Slotlight 2x32/35W T16	1503	3,500
92051	Slotlight 2x45/49W T16	1503	3,500
92053	Slotlight 2x73/80W T16	1503	3,500
92019	Slotlight 1 + 1x13/14W T16	1068	2,610
92021	Slotlight 1 + 1x20/24W T16	1068	2,610
92023	Slotlight 1 + 1x19/21W T16	1668	3,890
92025	Slotlight 1 + 1x34/39W T16	1668	3,890
92027	Slotlight 1 + 1x25/28W T16	2268	4,600
92029	Slotlight 1 + 1x50/54W T16	2268	4,600
92031	Slotlight 1 + 1x32/35W T16	2868	6,460
92033	Slotlight 1 + 1x45/49W T16	2868	6,460
92035	Slotlight 1 + 1x73/80W T16	2868	6,460
92055	Slotlight 2 + 2x13/14W T16	1280	3,230
92057	Slotlight 2 + 2x20/24W T16	1280	3,230
92059	Slotlight 2 + 2x19/21W T16	1880	3,900
92061	Slotlight 2 + 2x34/39W T16	1880	3,900
92063	Slotlight 2 + 2x25/28W T16	2480	4,900
92065	Slotlight 2 + 2x50/54W T16	2480	4,900
92067	Slotlight 2 + 2x32/35W T16	3080	7,300
92069	Slotlight 2 + 2x45/49W T16	3080	7,300
92071	Slotlight 2 + 2x73/80W T16	3080	7,300

Hole		
1-2x13/14W - 20/24W T16	86 x	585
1-2x19/21W - 34/39W T16	86 x	885
1-2x25/28W - 50/54W T16	86 x	1185
1-2x32/35W - 45/49W T16	86 x	1485
1-2x73/80W T16	86 x	1485
1 + 1x13/14W - 20/24W T16	86 x	1050
1 + 1x19/21W - 34/39W T16	86 x	1650
1 + 1x25/28W - 50/54W T16	86 x	2250
1 + 1x32/35W - 45/49W T16	86 x	2850
1 + 1x73/80W T16	86 x	2850
2 + 2x13/14W - 20/24W T16	86 x	1262
2 + 2x19/21W - 34/39W T16	86 x	1862
2 + 2x25/28W - 50/54W T16	86 x	2462
2 + 2x32/35W - 45/49W T16	86 x	3062
2 + 2x73/80W T16	86 x	3062

CE IP 20/43

T16

OSRAM T16 PHILIPS T16

Included

Colour Codes:

0	Colours	1	White	2	Titan	3	Black	5	matt Alum.	9	Anodized
---	---------	---	-------	---	-------	---	-------	---	------------	---	----------

SLOTLIGHT

SLOTLIGHT LED



- Version for LED CHIP.
- Aluminium body.
- Removable plastic heads.
- High efficient diffuser in opal PMMA.
- Flow recuperator in white colour.
- Suspension brackets not included.
- Efficiency: max.138 Lumen / Watt.

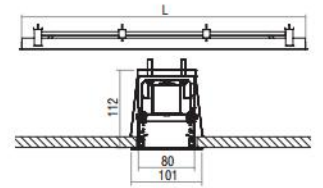

Code	Description	L	Kg
92073	Slotlight Led 16W 2200 lm Neutral	620	1,550
92074	Slotlight Led 28W 3100 lm Neutral	1180	2,930
92075	Slotlight Led 33W 4400 lm Neutral	1180	2,930
92076	Slotlight Led 42W 4650 lm Neutral	1740	4,320
92077	Slotlight Led 49W 6600 lm Neutral	1740	4,320
92078	Slotlight Led 56W 6200 lm Neutral	2300	5,700
92079	Slotlight Led 65W 8800 lm Neutral	2300	5,700
92080	Slotlight Led 16W 2200 lm Warm	620	1,550
92082	Slotlight Led 33W 4400 lm Warm	1180	2,930
92084	Slotlight Led 49W 6600 lm Warm	1740	4,320
92086	Slotlight Led 65W 8800 lm Warm	2300	5,700

Hole	
16W	86 x 602
28W - 33W	86 x 1162
42W - 49W	86 x 1722
56W - 65W	86 x 2282

Colour Codes:

- 0 Colours
 1 White
 2 Titan
 3 Black
 5 matt Alum.
 9 Anodized







SLOTLIGHT

SLOTLIGHT ANAGLYPH

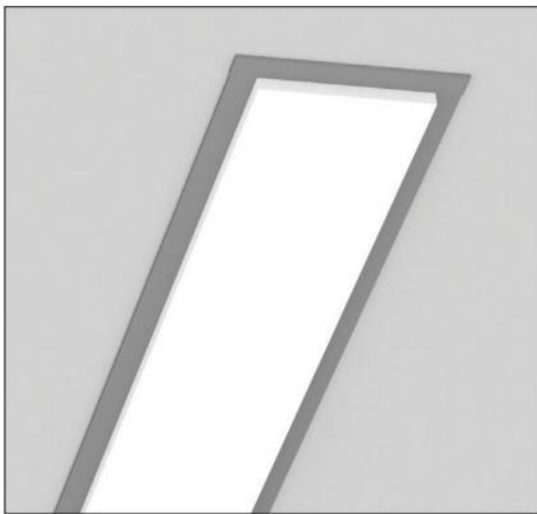

- Version for T16.
- Aluminium body.
- Removable plastic heads.
- Diffuser in opal of 10mm PMMA.
- Flow recuperator in white colour.
- Suspension and power supply not included.

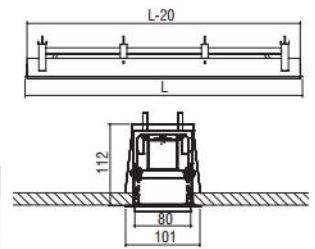

CE	F	IP 20
EN		43
T16		
OSRAM: T5		
PHILIPS: T1.5		
		Included

Code	Description	L	Kg
92401	Slotlight Anaglyph 1x13/14W T16	603	1,750
92403	Slotlight Anaglyph 1x20/24W T16	603	1,750
92405	Slotlight Anaglyph 1x19/21W T16	903	2,610
92407	Slotlight Anaglyph 1x34/39W T16	903	2,610
92409	Slotlight Anaglyph 1x25/28W T16	1203	3,480
92411	Slotlight Anaglyph 1x50/54W T16	1203	3,480
92413	Slotlight Anaglyph 1x32/35W T16	1503	4,350
92415	Slotlight Anaglyph 1x45/49W T16	1503	4,350
92417	Slotlight Anaglyph 1x73/80W T16	1503	4,350
92437	Slotlight Anaglyph 2x13/14W T16	603	1,750
92439	Slotlight Anaglyph 2x20/24W T16	603	1,750
92441	Slotlight Anaglyph 2x19/21W T16	903	2,610
92443	Slotlight Anaglyph 2x34/39W T16	903	2,610
92445	Slotlight Anaglyph 2x25/28W T16	1203	3,480
92447	Slotlight Anaglyph 2x50/54W T16	1203	3,480
92449	Slotlight Anaglyph 2x32/35W T16	1503	4,350
92451	Slotlight Anaglyph 2x45/49W T16	1503	4,350
92453	Slotlight Anaglyph 2x73/80W T16	1503	4,350
92419	Slotlight Anaglyph 1 + 1x13/14W T16	1068	3,090
92421	Slotlight Anaglyph 1 + 1x20/24W T16	1068	3,090
92423	Slotlight Anaglyph 1 + 1x19/21W T16	1668	4,820
92425	Slotlight Anaglyph 1 + 1x34/39W T16	1668	4,820
92427	Slotlight Anaglyph 1 + 1x25/28W T16	2268	6,560
92429	Slotlight Anaglyph 1 + 1x50/54W T16	2268	6,560
92431	Slotlight Anaglyph 1 + 1x32/35W T16	2868	8,290
92433	Slotlight Anaglyph 1 + 1x45/49W T16	2868	8,290
92435	Slotlight Anaglyph 1 + 1x73/80W T16	2868	8,290
92455	Slotlight Anaglyph 2 + 2x13/14W T16	1280	3,700
92457	Slotlight Anaglyph 2 + 2x20/24W T16	1280	3,700
92459	Slotlight Anaglyph 2 + 2x19/21W T16	1880	5,440
92461	Slotlight Anaglyph 2 + 2x34/39W T16	1880	5,440
92463	Slotlight Anaglyph 2 + 2x25/28W T16	2480	7,170
92465	Slotlight Anaglyph 2 + 2x50/54W T16	2480	7,170
92467	Slotlight Anaglyph 2 + 2x32/35W T16	3080	8,900
92469	Slotlight Anaglyph 2 + 2x45/49W T16	3080	8,900
92471	Slotlight Anaglyph 2 + 2x73/80W T16	3080	8,900

Hole	
1-2x13/14W - 20/24W T16	86 x 585
1-2x19/21W - 34/39W T16	86 x 885
1-2x25/28W - 50/54W T16	86 x 1185
1-2x32/35W - 45/49W T16	86 x 1485
1-2x73/80W T16	86 x 1485
1+1x13/14W - 20/24W T16	86 x 1050
1+1x19/21W - 34/39W T16	86 x 1650
1+1x25/28W - 50/54W T16	86 x 2250
1+1x32/35W - 45/49W T16	86 x 2850
1+1x73/80W T16	86 x 2850
2+2x13/14W - 20/24W T16	86 x 1262
2+2x19/21W - 34/39W T16	86 x 1862
2+2x25/28W - 50/54W T16	86 x 2462
2+2x32/35W - 45/49W T16	86 x 3062
2+2x73/80W T16	86 x 3062

Colour Codes:

- 0 Colours 1 White 2 Titan 3 Black 5 matt Alum. 9 Anodized

SLOTLIGHT

SLOTLIGHT ANAGLYPH LED

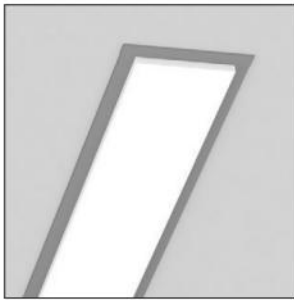

CE, F, IP 20, 43, LED, ta 25°C, Included

- Version for LED CHIP.
- Aluminium body.
- Removable plastic heads.
- Diffuser in opal of 10mm PMMA.
- Flow recuperator in white colour.
- Suspension brackets not included.
- Efficiency: max.138 Lumen / Watt.

Code	Description	L	Kg
92473	Slotlight An.Led 16W 2200 lm Neutral	620	1,790
92474	Slotlight An.Led 28W 3100 lm Neutral	1180	3,410
92475	Slotlight An.Led 33W 4400 lm Neutral	1180	3,410
92476	Slotlight An.Led 42W 4650 lm Neutral	1740	5,030
92477	Slotlight An.Led 49W 6600 lm Neutral	1740	5,030
92478	Slotlight An.Led 56W 6200 lm Neutral	2300	6,650
92479	Slotlight An.Led 65W 8800 lm Neutral	2300	6,650
92480	Slotlight An.Led 16W 2200 lm Warm	620	1,790
92482	Slotlight An.Led 33W 4400 lm Warm	1180	3,410
92484	Slotlight An.Led 49W 6600 lm Warm	1740	5,030
92486	Slotlight An.Led 65W 8800 lm Warm	2300	6,650

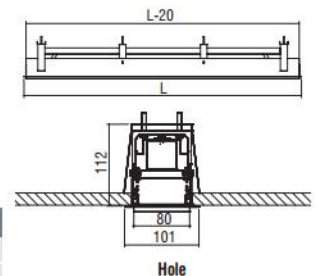

Hole

16W	86 x 602
28W - 33W	86 x 1162
42W - 49W	86 x 1722
56W - 65W	86 x 2282

Colour Codes:

0 Colours 1 White 2 Titan 3 Black 5 matt Alum. 9 Anodized

SLOTLIGHT WW

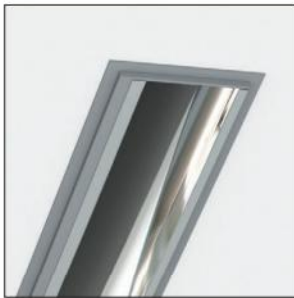

CE, F, IP 20, T16, OSRAM TO PHILIPS T16, Included

- Version for T16.
- Aluminium body.
- Removable plastic heads.
- Flow recuperator wall washer in semi-glossy anodized aluminium.
- Suspension brackets not included.

Code	Description	L	Kg
92203	Slotlight WW 1x20/24W T16	596	1,150
92207	Slotlight WW 1x34/39W T16	896	1,720
92211	Slotlight WW 1x50/54W T16	1196	2,300
92217	Slotlight WW 1x73/80W T16	1496	2,880

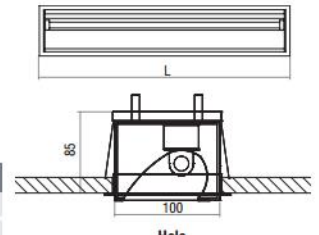

Hole

1x20/24W T16	110 x 586
1x34/39W T16	110 x 886
1x50/54W T16	110 x 1186
1x73/80W T16	110 x 1486

Colour Codes:

0 Colours 1 White 2 Titan 3 Black

SLOTLIGHT LOUVRE



CE, F, IP 20, T16, OSRAM TO PHILIPS T16, Included

- Version for T16.
- Aluminium body.
- Removable plastic heads.
- Parabolic reflector in specular anodized aluminium.
- Suspension brackets not included.

Code	Description	L	Kg
92103	Slotlight Louvre 1x20/24W T16	618	1,160
92107	Slotlight Louvre 1x34/39W T16	918	1,740
92111	Slotlight Louvre 1x50/54W T16	1218	2,310
92115	Slotlight Louvre 1x45/49W T16	1518	2,890
92117	Slotlight Louvre 1x73/80W T16	1518	2,890
92125	Slotlight Louvre 1+1x34/39W T16	1797	2,430
92129	Slotlight Louvre 1+1x50/54W T16	2397	4,580
92133	Slotlight Louvre 1+1x45/49W T16	2997	5,730
92135	Slotlight Louvre 1+1x73/80W T16	2997	5,730

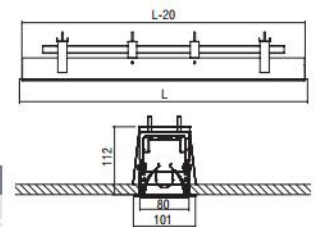

Hole

1x20/24W T16	86 x 600
1x34/39W T16	86 x 900
1x50/54W T16	86 x 1200
1x45/49W - 73/80W T16	86 x 1500
1+1x34/39W T16	86 x 1779
1+1x50/54W T16	86 x 2379
1+1x45/49W - 73/80W T16	86 x 2979

Colour Codes:

0 Colours 1 White 2 Titan 3 Black 5 matt Alum. 9 Anodized







L'ORÉAL  
PROFESSIONNEL



Συμβουλευτείτε τον κομμωτή σας  
για τις ανάγκες των μαλλιών σας

THE L'ORÉAL PARIS GROUP COMPANY BY NESTLÉ



SLOTLIGHT

SLOTLIGHT + Module 50 G5.3

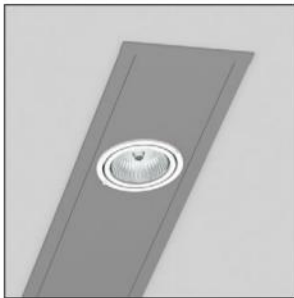

CE	F	IP 20
25°	350°	
OSRAM	LED	FLUO
		12V

- Simple version for incandescent halogen max.50W 12V (QR-CBC 51).

Code	Description	L	Kg
92304	Slotlight Module 50 1x max.50W/G5,3	300	1,570
92305	Slotlight Module 50 2x max.50W/G5,3	450	2,360

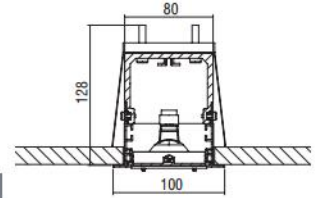

SLOTLIGHT + Module 50 GU10

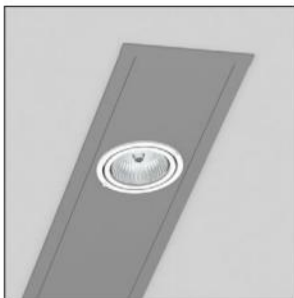

CE	F	IP 20
30°	350°	
PAR 16	LED	FLUO

- Simple version for incandescent halogen max.50W 230V (PAR16).

Code	Description	L	Kg
92301	Slotlight Module 50 1x max.50W/GU10	170	0,900
92302	Slotlight Module 50 2x max.50W/GU10	250	1,300

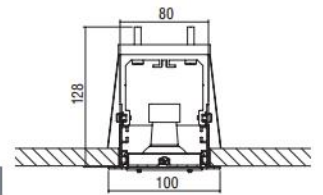

SLOTLIGHT + Module 50 IRA 2 Reflector

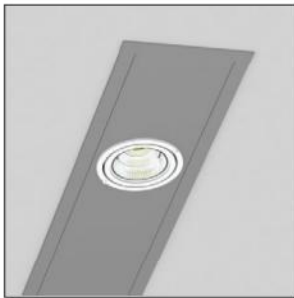

CE	F	IP 20
25°	350°	
LED	350mA	ta 25°C

- Reflectors: Medium, Wide.  
 - 7W power consumption driven at 350mA.  
 - Efficiency:  
 4000 K: 770 Lumen, CRI: min. 80  
 3000 K: 730 Lumen, CRI: min. 80  
 Maximum: 110 Lm/W

Code	Description	L	Kg
92307	Slotlight Module 50 1x IRA 2 7W Reflector	300	1,570
92308	Slotlight Module 50 2x IRA 2 7W Reflector	450	2,360

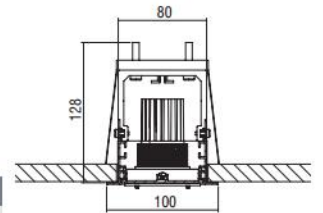

SLOTLIGHT + Module 50 DIMITRA 2 Reflector HO

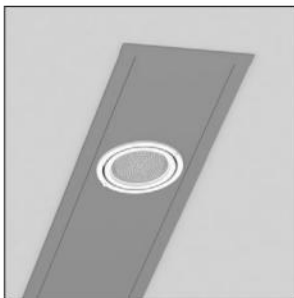

CE	F	IP 40
25°	350°	
LED	500mA	ta 25°C

- Reflectors: Spot, Medium, Wide.  
 - 5W power consumption driven at 500mA.  
 - Efficiency:  
 5W: 4000 K: 510 Lumen, CRI: min. 80  
 5W: 3000 K: 485 Lumen, CRI: min. 80  
 Maximum: 102 Lm/W

Code	Description	L	Kg
92309	Slotlight Module 50 1x DIMITRA 2 5W Ref.HO	300	1,570
92310	Slotlight Module 50 2x DIMITRA 2 5W Ref.HO	450	2,360

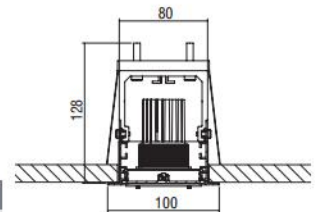

SLOTLIGHT + Module 50 ARTEMIS 2 Diffuser Prismatic

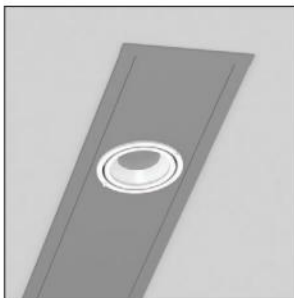

CE	F	IP 40
25°	350°	
D	LED	350/500mA
		ta 25°C

- Beam: Diffuser.  
 - 5W power consumption driven at 500mA.  
 - 7W power consumption driven at 350mA.  
 - Efficiency:  
 5W: 4000 K: 510 Lumen, CRI: min. 80  
 5W: 3000 K: 485 Lumen, CRI: min. 80  
 7W: 4000 K: 770 Lumen, CRI: min. 80  
 7W: 3000 K: 730 Lumen, CRI: min. 80  
 Maximum: 110 Lm/W

Code	Description	L	Kg
92311	Slotlight Module 50 1x ARTEMIS 2 5W Diffuser Prism.	300	1,570
92312	Slotlight Module 50 2x ARTEMIS 2 5W Diffuser Prism.	450	2,360
92313	Slotlight Module 50 1x ARTEMIS 2 7W Diffuser Prism.	300	1,570
92314	Slotlight Module 50 2x ARTEMIS 2 7W Diffuser Prism.	450	2,360

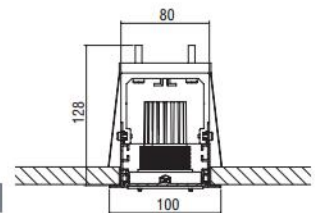

SLOTLIGHT

SLOTLIGHT + Module 50 ATHINA 2 Diffuser Opal

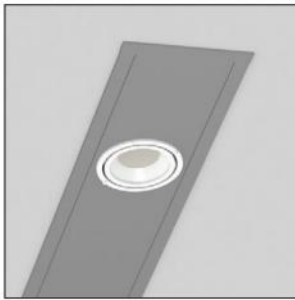

CE	F	IP 40
20°	350°	
D		
LED	ta 25°C	350/500mA

- Beam: Diffuser.
  - 5W power consumption driven at 500mA.
  - 7W power consumption driven at 350mA.
  - Efficiency:
- |                   |                                 |
|-------------------|---------------------------------|
| 5W:               | 4000 K: 510 Lumen, CRI: min. 80 |
| 5W:               | 3000 K: 485 Lumen, CRI: min. 80 |
| 7W:               | 4000 K: 770 Lumen, CRI: min. 80 |
| 7W:               | 3000 K: 730 Lumen, CRI: min. 80 |
| Maximum: 110 Lm/W |                                 |

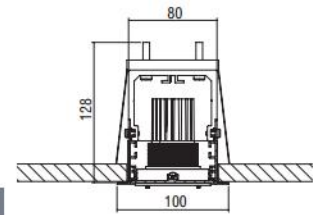

Code	Description	L	Kg
92315-00	Slotlight Module 50 1x ATHINA 2 5W Diffuser Opal	300	1,570
92316-00	Slotlight Module 50 2x ATHINA 2 5W Diffuser Opal	450	2,360
92317-00	Slotlight Module 50 1x ATHINA 2 7W Diffuser Opal	300	1,570
92318-00	Slotlight Module 50 2x ATHINA 2 7W Diffuser Opal	450	2,360

SLOTLIGHT + Module 50 VENUS 2 Lens

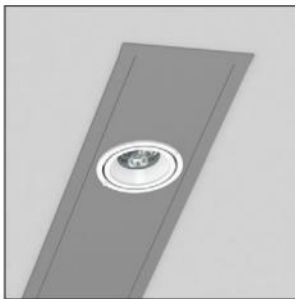

CE	F	IP 40
25°	350°	
LED	ta 25°C	350/700mA

- Lens: Spot, Medium, Wide.
  - 3W power consumption driven at 350mA.
  - 6W power consumption driven at 700mA.
  - Efficiency:
- |                   |                                 |
|-------------------|---------------------------------|
| 3W:               | 4000 K: 321 Lumen, CRI: min. 75 |
| 3W:               | 3000 K: 300 Lumen, CRI: min. 80 |
| 6W:               | 4000 K: 600 Lumen, CRI: min. 75 |
| 6W:               | 3000 K: 570 Lumen, CRI: min. 80 |
| Maximum: 107 Lm/W |                                 |

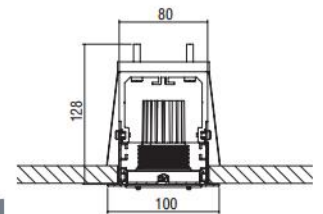

Code	Description	L	Kg
92319-00	Slotlight Module 50 1x VENUS 2 3W/6W Lens	300	1,570
92320-00	Slotlight Module 50 2x VENUS 2 3W/6W Lens	450	2,360

SLOTLIGHT + Module 30

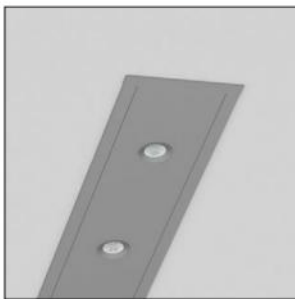

CE	F	IP 20
0°	0°	
LED	ta 25°C	Included

- Version for LED CHIP.
- Aluminium body.
- Lens in Spot, Medium, Wide or spot reflector selection.

Code	Description	L	Kg
92321-00	Slotlight Module 30 1x2W Lens	240	1,260
92322-00	Slotlight Module 30 2x2W Lens	320	1,680
92323-00	Slotlight Module 30 3x2W Lens	400	2,100
92324-01	Slotlight Module 30 1x2W Reflector	240	1,260
92325-01	Slotlight Module 30 2x2W Reflector	320	1,680
92326-01	Slotlight Module 30 3x2W Reflector	400	2,100

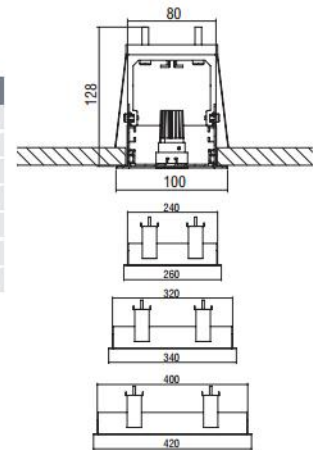

LED COLOUR CODES:

2	Warm	3	Neutral
---	------	---	---------

BEAM CODES:

01	spot	02	medium	03	wide
----	------	----	--------	----	------

Colour Codes:

0	Colours	1	White	2	Titan	3	Black	5	matt Alum.	9	Anodized
---	---------	---	-------	---	-------	---	-------	---	------------	---	----------

SLOTLIGHT ACCESSORIES

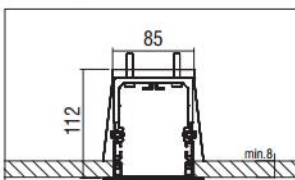

CE		
----	--	--

- Metal suspension bracket.
- Required 1pc per 1m profile length.

Code	Description	Kg
900210	Suspension Bracket Slotlight / Slotlight Louvre	0,270
900220	Suspension Bracket Slotlight WW	0,270

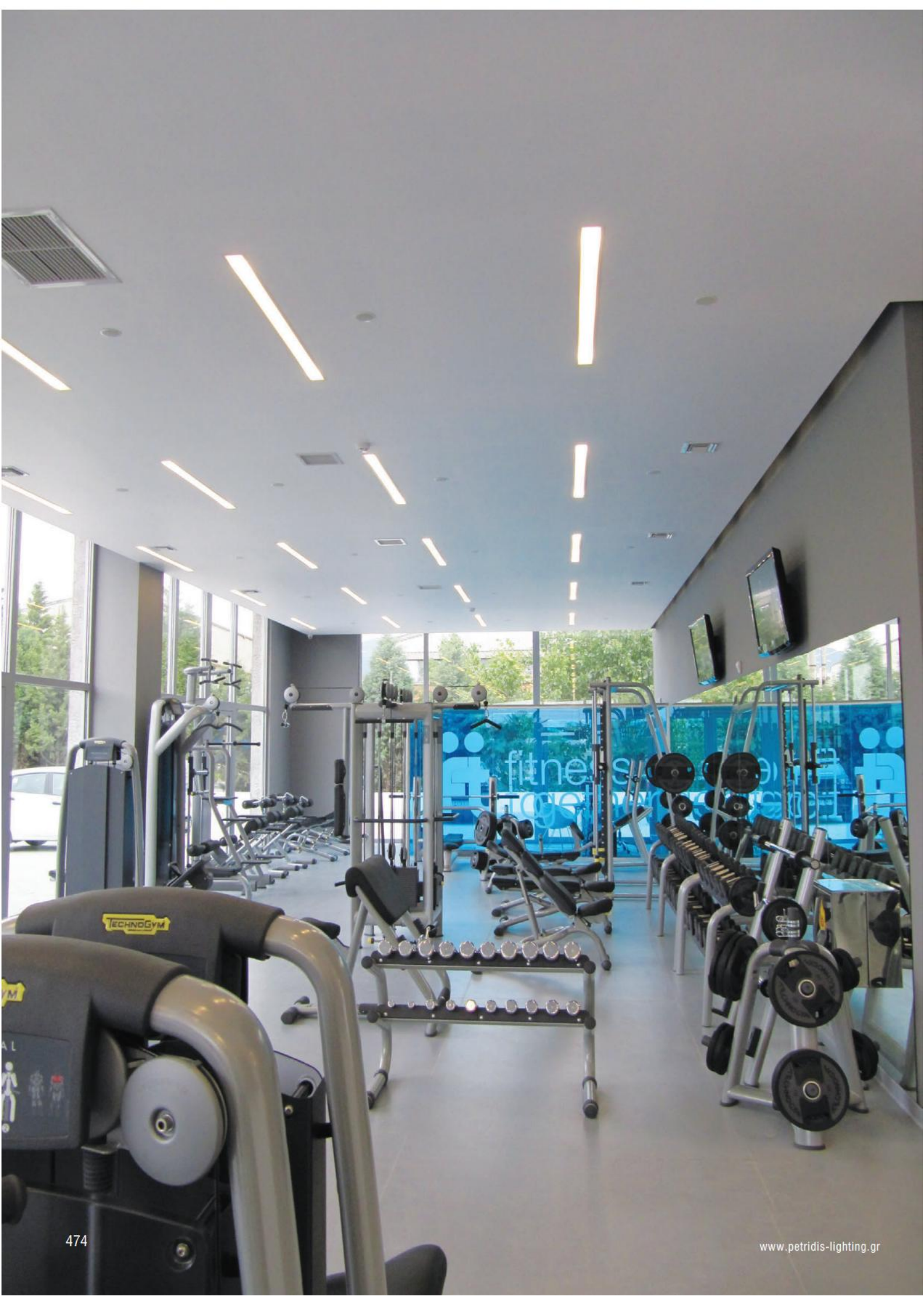



## STREAMLIGHT

*This luminaire combines the architectural style with the efficiency. It produces perfect lighting conditions without annoying reflections and that is why it can be used from entrance areas to offices. Uniformly illuminated lines with no dark shadows can be created thanks to the Tetris technology of T16 lamps.*

*The LED version escapes the restrictions of the T16 lamp by using LED lighting points that can have any spacing pitch and this gives the light line enormous flexibility.*

*The visual benefit: The continuous-row system is illuminated absolutely uniformly from beginning to end, is economically efficient, is maintenance-free and it has long service life.*

### Technical Features

- Housing from aluminium profile, painted electrostatically in selected colour.
- Removable plastic heads.
- High efficient diffuser in opal PMMA.
- Flow recuperator in white colour.

#### Upon request

- Connection for operation with electronic dimmable ballast.
- Available in IP54 protection version.

#### For LED Version

- Pure light without IR/UV radiation.
- Efficient thermal management.
- Up to 28W/m and 3864 Lm luminous flux range.
- Operation life: 50,000 hours with efficiency > 70% of the initial luminous flux.
- Connection for operation on 230V/50Hz.

#### Upon request:

- Available with highest colour rendering index (CRI)
- Available in IP54 protection version.



MIGATO



STREAMLIGHT

STREAMLIGHT TETRIS

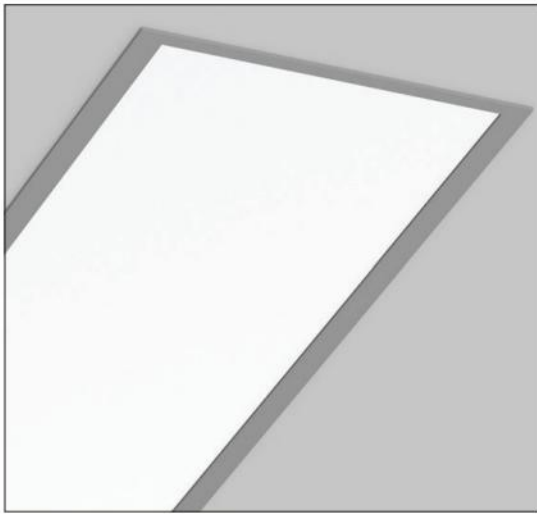

- Version for T16.
- Aluminium body.
- Removable plastic heads.
- High efficient diffuser in opal PMMA.
- Flow recuperator in white colour.
- Suspension brackets not included.

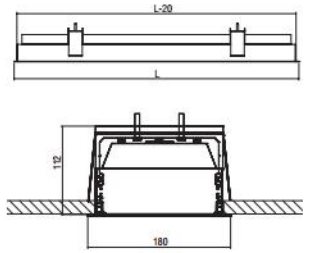

Hole	
2x13/14W - 20/24W T16	169 x 585
2x19/21W - 34/39W T16	169 x 885
2x25/28W - 50/54W T16	169 x 1185
2x32/35W - 45/49W T16	169 x 1485
2x73/80W T16	169 x 1485
2+2x25/28W - 50/54W T16	169 x 2250
2+2x32/35W - 45/49W T16	169 x 2850
2+2x73/80W T16	169 x 2850

Code	Description	L	Kg
93837	Streamlight Tetris 2x13/14W T16	603	1,800
93839	Streamlight Tetris 2x20/24W T16	603	1,800
93841	Streamlight Tetris 2x19/21W T16	903	2,700
93843	Streamlight Tetris 2x34/39W T16	903	2,700
93845	Streamlight Tetris 2x25/28W T16	1203	3,300
93847	Streamlight Tetris 2x50/54W T16	1203	3,300
93849	Streamlight Tetris 2x32/35W T16	1503	3,900
93851	Streamlight Tetris 2x45/49W T16	1503	3,900
93853	Streamlight Tetris 2x73/80W T16	1503	3,900
93863	Streamlight Tetris 2+2x25/28W T16	2268	7,400
93865	Streamlight Tetris 2+2x50/54W T16	2268	7,400
93867	Streamlight Tetris 2+2x32/35W T16	2868	7,150
93869	Streamlight Tetris 2+2x45/49W T16	2868	7,150
93871	Streamlight Tetris 2+2x73/80W T16	2868	7,150

CE IP 20  
43

T16

OSRAM TO PHILIPS T16

Included

STREAMLIGHT LED

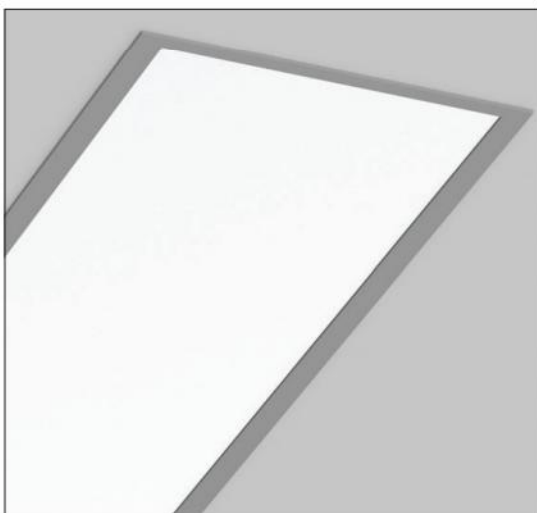

- Version for LED CHIP.
- Aluminium body.
- Removable plastic heads.
- High efficient diffuser in opal PMMA.
- Flow recuperator in white colour.
- Suspension brackets not included.
- Efficiency: max.138 Lumen / Watt.

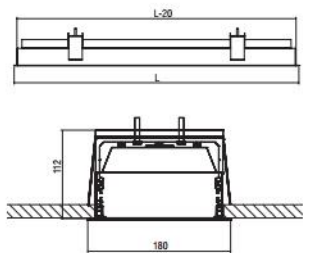

Hole	
16W	169 x 602
33W	169 x 1162
49W	169 x 1722
65W	169 x 2282

Code	Description	L	Kg
93873	Streamlight Led 16W 2200 lm Neutral	620	1,850
93874	Streamlight Led 33W 4400 lm Neutral	1180	3,520
93875	Streamlight Led 49W 6600 lm Neutral	1740	5,200
93876	Streamlight Led 65W 8800 lm Neutral	2300	6,800
93877	Streamlight Led 16W 2200 lm Warm	620	1,850
93878	Streamlight Led 33W 4400 lm Warm	1180	3,520
93879	Streamlight Led 49W 6600 lm Warm	1740	5,200
93880	Streamlight Led 65W 8800 lm Warm	2300	6,800

CE IP 20  
43

LED ta 25°C

Included

Colour Codes:

- 0 Colours 1 White 2 Titan 3 Black 5 matt Alum. 9 Anodized





STREAMLIGHT

STREAMLIGHT ANAGLYPH

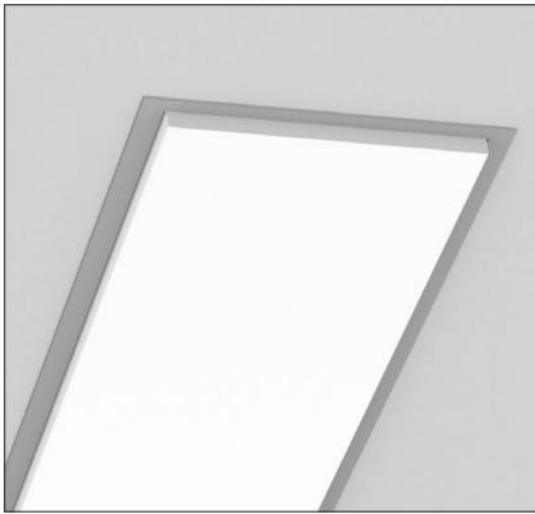

- Version for T16.
- Aluminium body.
- Removable plastic heads.
- Diffuser in opal of 10mm PMMA.
- Flow recuperator in white colour.
- Suspension brackets not included.

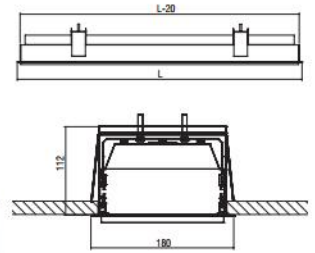

Code	Description	L	Kg
94037	Streamlight Anaglyph 2x13/14W T16	603	2,420
94039	Streamlight Anaglyph 2x20/24W T16	603	2,420
94041	Streamlight Anaglyph 2x19/21W T16	903	3,620
94043	Streamlight Anaglyph 2x34/39W T16	903	3,620
94045	Streamlight Anaglyph 2x25/28W T16	1203	4,830
94047	Streamlight Anaglyph 2x50/54W T16	1203	4,830
94049	Streamlight Anaglyph 2x32/35W T16	1503	6,030
94051	Streamlight Anaglyph 2x45/49W T16	1503	6,030
94053	Streamlight Anaglyph 2x73/80W T16	1503	6,030
94063	Streamlight Anaglyph 2+2x25/28W T16	2268	9,100
94065	Streamlight Anaglyph 2+2x50/54W T16	2268	9,100
94067	Streamlight Anaglyph 2+2x32/35W T16	2868	11,500
94069	Streamlight Anaglyph 2+2x45/49W T16	2868	11,500
94071	Streamlight Anaglyph 2+2x73/80W T16	2868	11,500

**Hole**

2x13/14W - 20/24W T16	169 x 585
2x19/21W - 34/39W T16	169 x 885
2x25/28W - 50/54W T16	169 x 1185
2x32/35W - 45/49W T16	169 x 1485
2x73/80W T16	169 x 1485
2+2x25/28W - 50/54W T16	169 x 2375
2+2x32/35W - 45/49W T16	169 x 2975
2+2x73/80W T16	169 x 2975

CE F IP 20 43

T16

OSRAM: 15 PHILIPS: 15.5

Included

STREAMLIGHT ANAGLYPH LED



- Version for LED CHIP.
- Aluminium body.
- Removable plastic heads.
- Diffuser in opal of 10mm PMMA.
- Flow recuperator in white colour.
- Suspension brackets not included.
- Efficiency: max.138 Lumen / Watt.

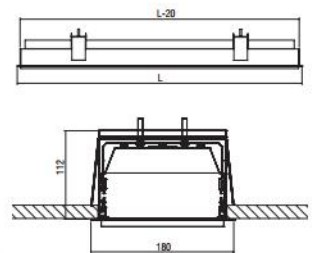

Code	Description	L	Kg
94073	Streamlight An.Led 16W 2200 lm Neutral	620	2,490
94074	Streamlight An.Led 33W 4400 lm Neutral	1180	4,730
94075	Streamlight An.Led 49W 6600 lm Neutral	1740	6,980
94076	Streamlight An.Led 65W 8800 lm Neutral	2300	9,230
94077	Streamlight An.Led 16W 2200 lm Warm	620	2,490
94078	Streamlight An.Led 33W 4400 lm Warm	1180	4,730
94079	Streamlight An.Led 49W 6600 lm Warm	1740	6,980
94080	Streamlight An.Led 65W 8800 lm Warm	2300	9,230

**Hole**

16W	169 x 602
33W	169 x 1162
49W	169 x 1722
65W	169 x 2282

CE F IP 20 43

LED

1a 25°C

Included

Colour Codes:

0	Colours	1	White	2	Titan	3	Black	5	matt Alum.	9	Anodized
---	---------	---	-------	---	-------	---	-------	---	------------	---	----------

STREAMLIGHT

STREAMLIGHT PLEXI OPAL CARRE

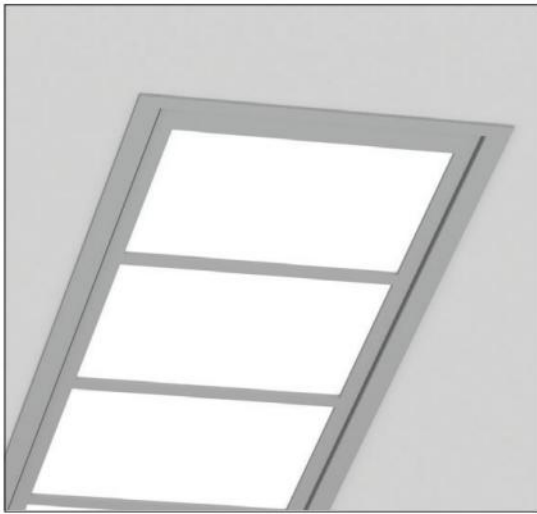

- Version for T16.
- Aluminium body.
- Removable plastic heads.
- High efficient diffuser in opal PMMA.
- Flow recuperator in white colour.
- Suspension brackets not included.

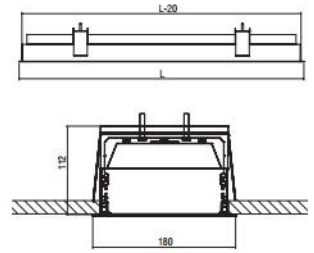

Code	Description	L	Kg
93537	Streamlight Plexi Opal Carré 2x13/14W T16	603	1,690
93539	Streamlight Plexi Opal Carré 2x20/24W T16	603	1,690
93541	Streamlight Plexi Opal Carré 2x19/21W T16	902	2,600
93543	Streamlight Plexi Opal Carré 2x34/39W T16	902	2,600
93545	Streamlight Plexi Opal Carré 2x25/28W T16	1203	3,370
93547	Streamlight Plexi Opal Carré 2x50/54W T16	1203	3,370
93549	Streamlight Plexi Opal Carré 2x32/35W T16	1503	4,210
93551	Streamlight Plexi Opal Carré 2x45/49W T16	1503	4,210
93553	Streamlight Plexi Opal Carré 2x73/80W T16	1503	4,210
93563	Streamlight Plexi Opal Carré 2+2x25/28W T16	2268	6,350
93565	Streamlight Plexi Opal Carré 2+2x50/54W T16	2268	6,350
93567	Streamlight Plexi Opal Carré 2+2x32/35W T16	2868	8,030
93569	Streamlight Plexi Opal Carré 2+2x45/49W T16	2868	8,030
93571	Streamlight Plexi Opal Carré 2+2x73/80W T16	2868	8,030

Hole

2x13/14W - 20/24W T16	169 x 585
2x19/21W - 34/39W T16	169 x 885
2x25/28W - 50/54W T16	169 x 1185
2x32/35W - 45/49W T16	169 x 1485
2x73/80W T16	169 x 1485
2+2x25/28W - 50/54W T16	169 x 2375
2+2x32/35W - 45/49W T16	169 x 2975
2+2x73/80W T16	169 x 2975

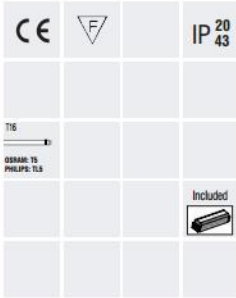

STREAMLIGHT PLEXI OPAL CARRE LED

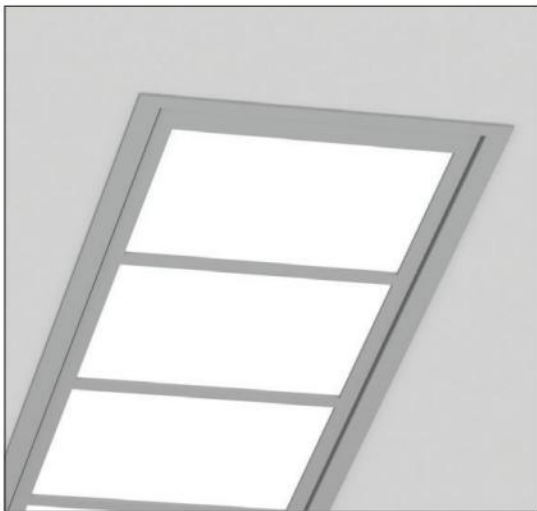

- Version for LED CHIP.
- Aluminium body.
- Removable plastic heads.
- High efficient diffuser in opal PMMA.
- Flow recuperator in white colour.
- Suspension brackets not included.
- Efficiency: max.138 Lumen / Watt.

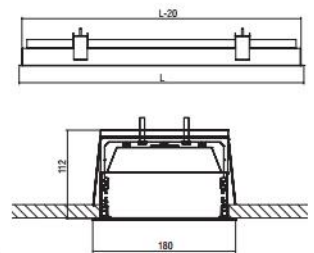

Code	Description	L	Kg
93573	Streamlight Plexi Opal Carré Led 16W 2200 lm Neutral	620	1,820
93574	Streamlight Plexi Opal Carré Led 33W 4400 lm Neutral	1180	3,460
93575	Streamlight Plexi Opal Carré Led 49W 6600 lm Neutral	1740	5,080
93576	Streamlight Plexi Opal Carré Led 65W 8800 lm Neutral	2300	6,750
93577	Streamlight Plexi Opal Carré Led 16W 2200 lm Warm	620	1,820
93578	Streamlight Plexi Opal Carré Led 33W 4400 lm Warm	1180	3,460
93579	Streamlight Plexi Opal Carré Led 49W 6600 lm Warm	1740	5,080
93580	Streamlight Plexi Opal Carré Led 65W 8800 lm Warm	2300	6,750

Hole

16W	169 x 602
33W	169 x 1162
49W	169 x 1722
65W	169 x 2282



Colour Codes:

0 Colours 1 White 2 Titan 3 Black 5 matt Alum. 9 Anodized

STREAMLIGHT

STREAMLIGHT PLEXI OPAL DOUBLE

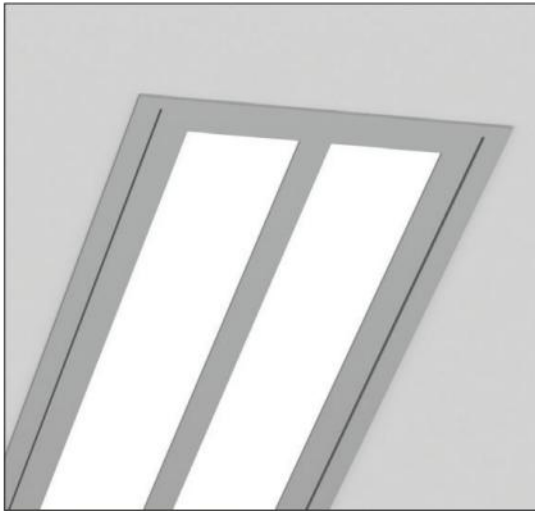

- Version for T16.
- Aluminium body.
- Removable plastic heads.
- High efficient diffuser in opal PMMA.
- Flow recuperator in white colour.
- Suspension brackets not included.

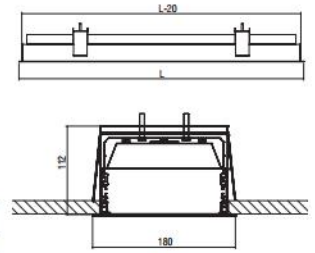

Code	Description	L	Kg
93637	Streamlight Plexi Opal Double 2x13/14W T16	603	1,690
93639	Streamlight Plexi Opal Double 2x20/24W T16	603	1,690
93641	Streamlight Plexi Opal Double 2x19/21W T16	902	2,600
93643	Streamlight Plexi Opal Double 2x34/39W T16	902	2,600
93645	Streamlight Plexi Opal Double 2x25/28W T16	1203	3,370
93647	Streamlight Plexi Opal Double 2x50/54W T16	1203	3,370
93649	Streamlight Plexi Opal Double 2x32/35W T16	1503	4,210
93651	Streamlight Plexi Opal Double 2x45/49W T16	1503	4,210
93653	Streamlight Plexi Opal Double 2x73/80W T16	1503	4,210
93663	Streamlight Plexi Opal Double 2+2x25/28W T16	2268	6,350
93665	Streamlight Plexi Opal Double 2+2x50/54W T16	2268	6,350
93667	Streamlight Plexi Opal Double 2+2x32/35W T16	2868	8,030
93669	Streamlight Plexi Opal Double 2+2x45/49W T16	2868	8,030
93671	Streamlight Plexi Opal Double 2+2x73/80W T16	2868	8,030

**Hole**

2x13/14W - 20/24W T16	169 x 585
2x19/21W - 34/39W T16	169 x 885
2x25/28W - 50/54W T16	169 x 1185
2x32/35W - 45/49W T16	169 x 1485
2x73/80W T16	169 x 1485
2+2x25/28W - 50/54W T16	169 x 2375
2+2x32/35W - 45/49W T16	169 x 2975
2+2x73/80W T16	169 x 2975

CE F IP 20 43

T16

OPAL: 15  
PLEXI: 15

Included

STREAMLIGHT PLEXI OPAL DOUBLE LED

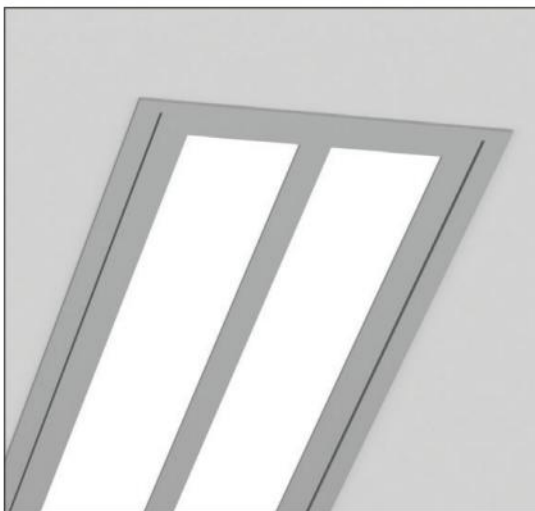

- Version for LED CHIP.
- Aluminium body.
- Removable plastic heads.
- High efficient diffuser in opal PMMA.
- Flow recuperator in white colour.
- Suspension brackets not included.
- Efficiency: max.138 Lumen / Watt.

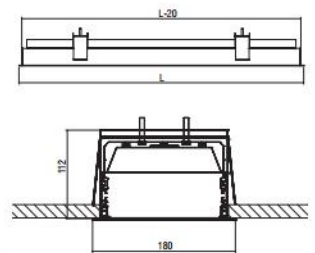

Code	Description	L	Kg
93673	Streamlight Plexi Opal Double Led 16W 2200 lm Neutral	620	1,820
93674	Streamlight Plexi Opal Double Led 33W 4400 lm Neutral	1180	3,460
93675	Streamlight Plexi Opal Double Led 49W 6600 lm Neutral	1740	5,080
93676	Streamlight Plexi Opal Double Led 65W 8800 lm Neutral	2300	6,750
93677	Streamlight Plexi Opal Double Led 16W 2200 lm Warm	620	1,820
93678	Streamlight Plexi Opal Double Led 33W 4400 lm Warm	1180	3,460
93679	Streamlight Plexi Opal Double Led 49W 6600 lm Warm	1740	5,080
93680	Streamlight Plexi Opal Double Led 65W 8800 lm Warm	2300	6,750

**Hole**

16W	169 x 602
33W	169 x 1162
49W	169 x 1722
65W	169 x 2282

CE F IP 20 43

LED

LED CHIP

ta 25°C

Included

Colour Codes:

- 0 Colours 1 White 2 Titan 3 Black 5 matt Alum. 9 Anodized

STREAMLIGHT

STREAMLIGHT WW



- Version for T16.
- Aluminium body.
- Removable plastic heads.
- High efficient diffuser in opal PMMA.
- Flow recuperator wall washer in semi-glossy anodized aluminium.
- Suspension brackets not included.

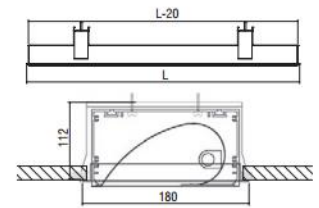

Hole

1x20/24W T16	176 x 590
1x34/39W T16	176 x 890
1x50/54W T16	176 x 1190
1x73/80W T16	176 x 1490

Code	Description	L	Kg
94103	Streamlight WW 1x20/24W T16	600	1,610
94107	Streamlight WW 1x34/39W T16	900	2,420
94111	Streamlight WW 1x50/54W T16	1200	3,220
94117	Streamlight WW 1x73/80W T16	1500	4,020

CE IP 43

T16

OSRAM TO PHILIPS T16

Included

STREAMLIGHT LOUVRE

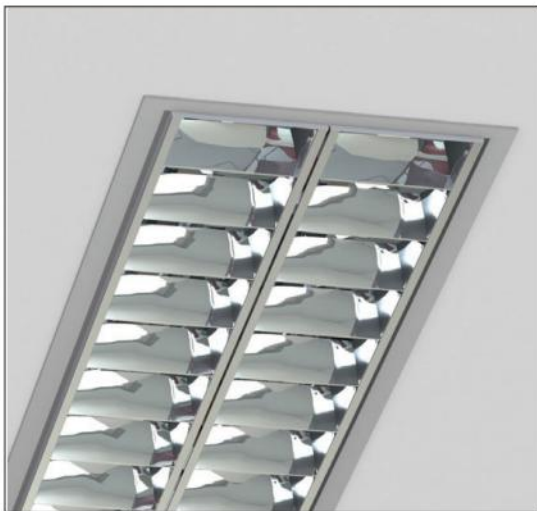

- Version for T16.
- Aluminium body.
- Removable plastic heads.
- High efficient diffuser in opal PMMA.
- Parabolic louvre.
- Flow recuperator from specular aluminium.
- Suspension brackets not included.

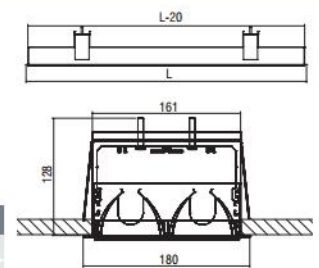

Hole

2x13/14W - 20/24W T16	169 x 600
2x19/21W - 34/39W T16	169 x 900
2x25/28W - 50/54W T16	169 x 1200
2x32/35W - 45/49W T16	169 x 1500
2x73/80W T16	169 x 1500

Code	Description	L	Kg
94237	Streamlight Louvre 2x13/14W T16	618	1,430
94239	Streamlight Louvre 2x20/24W T16	618	1,430
94241	Streamlight Louvre 2x19/21W T16	918	2,130
94243	Streamlight Louvre 2x34/39W T16	918	2,130
94245	Streamlight Louvre 2x25/28W T16	1218	2,840
94247	Streamlight Louvre 2x50/54W T16	1218	2,840
94249	Streamlight Louvre 2x32/35W T16	1518	3,580
94251	Streamlight Louvre 2x45/49W T16	1518	3,580
94253	Streamlight Louvre 2x73/80W T16	1518	3,580
94263	Streamlight Louvre 2+2x25/28W T16	2397	6,580
94265	Streamlight Louvre 2+2x50/54W T16	2397	6,580
94267	Streamlight Louvre 2+2x32/35W T16	2997	8,230
94269	Streamlight Louvre 2+2x45/49W T16	2997	8,230
94271	Streamlight Louvre 2+2x73/80W T16	2997	8,230

2+2x25/28W - 50/54W T16	169 x 2379
2+2x32/35W - 45/49W T16	169 x 2979
2+2x73/80W T16	169 x 2979

CE IP 43

T16

OSRAM TO PHILIPS T16

Included

Colour Codes:

- 0 Colours 1 White 2 Titan 3 Black 5 matt Alum. 9 Anodized

STREAMLIGHT

STREAMLIGHT + Module 60 POSIDON HI-PAR 111

Module 60 POSIDON HI-PAR 111



CE		850°C	IP 20
			Included

- Version for HI-PAR 111/GX8,5.
- Outer adjustable ring from die-cast aluminium.
- Inner ring for easy lamp replacement.

Code	Description	L	Kg
93915	Streamlight Module 60 POSIDON 35W HI-PAR 111/GX8,5	350	1,270
93916	Streamlight Module 60 POSIDON 70W HI-PAR 111/GX8,5	350	1,270

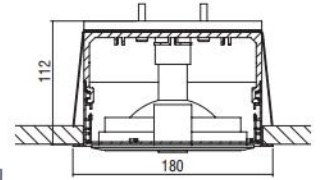

STREAMLIGHT + Module 60 DIONISOS QR111

Module 60 DIONISOS QR111



CE		850°C	IP 20
			Included

- Version for QR111/G53.
- Outer adjustable ring from die-cast aluminium.
- Inner ring for easy lamp replacement.

Code	Description	L	Kg
93917	Streamlight Module 60 DIONISOS max.70W QR111/G53	350	1,270

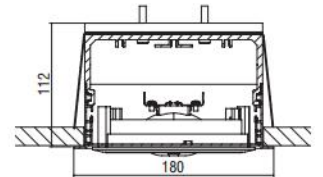

STREAMLIGHT + Module 60 APOLLON HIT-CE

Module 60 APOLLON HIT-CE



CE		850°C	IP 20
			Included

- Version for HIT-CE/G12.
- Outer adjustable ring from die-cast aluminium.
- Inner ring for easy lamp replacement.
- High pure aluminium reflectors in Spot, Medium, Wide.
- Tempered protection glass.

Code	Description	L	Kg
93919	Streamlight Module 60 APOLLON 35W HIT-CE/G12 S	350	1,270
93920	Streamlight Module 60 APOLLON 35W HIT-CE/G12 M	350	1,270
93921	Streamlight Module 60 APOLLON 35W HIT-CE/G12 W	350	1,270
93922	Streamlight Module 60 APOLLON 70W HIT-CE/G12 S	350	1,270
93923	Streamlight Module 60 APOLLON 70W HIT-CE/G12 M	350	1,270
93924	Streamlight Module 60 APOLLON 70W HIT-CE/G12 W	350	1,270

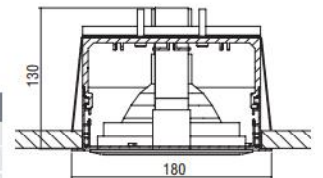

STREAMLIGHT + Module 60 IFESTOS HIT-TC-CE

Module 60 IFESTOS HIT-TC-CE



CE		850°C	IP 20
			Included

- Version for HIT-TC-CE/G8,5.
- Outer adjustable ring from die-cast aluminium.
- Inner ring for easy lamp replacement.
- High pure aluminium reflectors in Spot, Medium, Wide.
- Tempered protection glass.

Code	Description	L	Kg
93925	Streamlight Module 60 IFESTOS 35W HIT-TC-CE /G8,5 S	350	1,270
93926	Streamlight Module 60 IFESTOS 35W HIT-TC-CE /G8,5 M	350	1,270
93927	Streamlight Module 60 IFESTOS 35W HIT-TC-CE /G8,5 W	350	1,270
93928	Streamlight Module 60 IFESTOS 70W HIT-TC-CE /G8,5 S	350	1,270
93929	Streamlight Module 60 IFESTOS 70W HIT-TC-CE /G8,5 M	350	1,270
93930	Streamlight Module 60 IFESTOS 70W HIT-TC-CE /G8,5 W	350	1,270

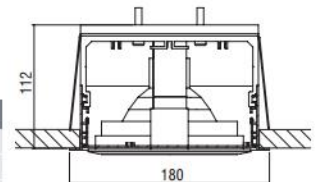



STREAMLIGHT

STREAMLIGHT + Module 60 ARIS LED R111

Module 60 ARIS LED R111

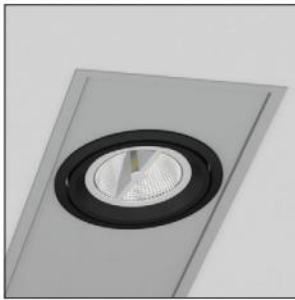

CE	F	850°C	IP 20
60°	350°		
LED			

- Version for LED R111/GU10.
- Outer adjustable ring from die-cast aluminium.
- Inner ring for easy lamp replacement.
- Connection for 230V/50Hz.

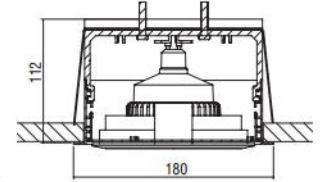

Code	Description	L	Kg
93918	Streamlight Module 60 ARIS LED R111/GU10/230V	350	1,270

STREAMLIGHT + Module 60 DIAS LED

Module 60 DIAS LED

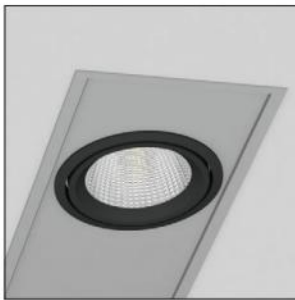

CE	F	850°C	IP 20
60°	350°		
LED	ta 25°C	Included	

- Version with LED Module.
  - Outer adjustable ring from die-cast aluminium.
  - 22W power consumption driven at 500mA.
  - 30W power consumption driven at 700mA.
  - Efficiency:
- |      |         |                          |
|------|---------|--------------------------|
| 22W: | 4000 K: | 2440 Lumen, CRI: min. 80 |
| 22W: | 3000 K: | 2331 Lumen, CRI: min. 80 |
| 30W: | 4000 K: | 3290 Lumen, CRI: min. 80 |
| 30W: | 3000 K: | 3143 Lumen, CRI: min. 80 |
- Maximum: 111 Lm/W

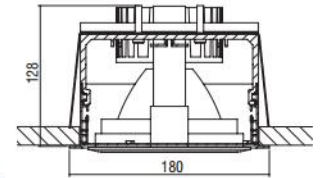

Code	Description	L	Kg
939312	Streamlight Module 60 DIAS LED CHIP 22W	350	1,270
939313	Streamlight Module 60 DIAS LED CHIP 22W	350	1,270
939322	Streamlight Module 60 DIAS LED CHIP 30W	350	1,270
939323	Streamlight Module 60 DIAS LED CHIP 30W	350	1,270

STREAMLIGHT + Module 60 KRONOS HIT-TC-CE

Module 60 KRONOS HIT-TC-CE



CE	F	850°C	IP 20
60°	350°		
HIT-TC-CE/GU6,5			Included

- Version for HIT-TC-CE/GU6,5.
- Outer adjustable ring from die-cast aluminium.
- Die-cast aluminium spot inside.
- High pure aluminium reflectors in Spot, Medium, Wide.
- Tempered protection glass.

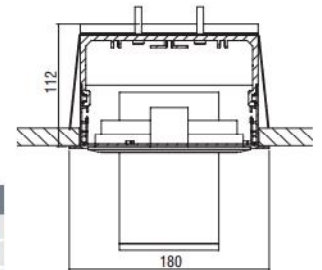

Code	Description	L	Kg
93933	Streamlight Module 60 KRONOS 20W HIT-TC-CE/GU6,5 S	350	1,170
93934	Streamlight Module 60 KRONOS 20W HIT-TC-CE/GU6,5 M	350	1,170
93935	Streamlight Module 60 KRONOS 20W HIT-TC-CE/GU6,5 W	350	1,170
93936	Streamlight Module 60 KRONOS 35W HIT-TC-CE/GU6,5 S	350	1,170
93937	Streamlight Module 60 KRONOS 35W HIT-TC-CE/GU6,5 M	350	1,170
93938	Streamlight Module 60 KRONOS 35W HIT-TC-CE/GU6,5 W	350	1,170

STREAMLIGHT + Module 60 KRONOS LED

Module 60 KRONOS LED



CE	F	850°C	IP 20
60°	350°		
LED	ta 25°C	Included	

- Version with LED Module.
  - Outer adjustable ring from die-cast aluminium.
  - Die-cast aluminium spot inside.
  - 22W power consumption driven at 500mA.
  - Efficiency:
- |      |         |                          |
|------|---------|--------------------------|
| 22W: | 4000 K: | 2440 Lumen, CRI: min. 80 |
| 22W: | 3000 K: | 2331 Lumen, CRI: min. 80 |
- Maximum: 111 Lm/W

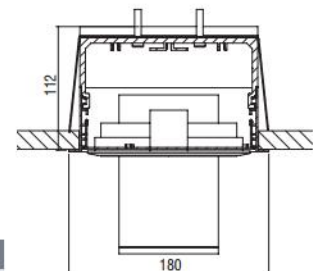

Code	Description	L	Kg
939392	Streamlight Module 60 KRONOS LED CHIP 22W	350	1,170
939393	Streamlight Module 60 KRONOS LED CHIP 22W	350	1,170

STREAMLIGHT

STREAMLIGHT + Module 40 THETIS HIT-TC-CE

Module 40 THETIS HIT-TC-CE

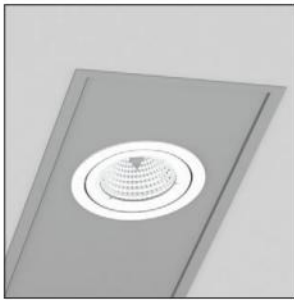

CE	F	IP 20	
80°	350°		
HIT-TC-CE/GU6,5			Included
OSRAM, HET-SP			PHILIPS, COB 1m

- Version for HIT-TC-CE/GU6,5.
- Reflector: Spot, Medium, Wide.
- Tempered protection glass.

Code	Description	L	Kg
93941	Streamlight Module 40 THETIS 20W HIT-TC-CE/GU6,5 S	350	1,580
93942	Streamlight Module 40 THETIS 20W HIT-TC-CE/GU6,5 M	350	1,580
93943	Streamlight Module 40 THETIS 20W HIT-TC-CE/GU6,5 W	350	1,580
93944	Streamlight 2x Module 40 THETIS 20W HIT-TC-CE/GU6,5 S	550	2,480
93945	Streamlight 2x Module 40 THETIS 20W HIT-TC-CE/GU6,5 M	550	2,480
93946	Streamlight 2x Module 40 THETIS 20W HIT-TC-CE/GU6,5 W	550	2,480
93947	Streamlight Module 40 THETIS 35W HIT-TC-CE/GU6,5 S	350	1,580
93948	Streamlight Module 40 THETIS 35W HIT-TC-CE/GU6,5 M	350	1,580
93949	Streamlight Module 40 THETIS 35W HIT-TC-CE/GU6,5 W	350	1,580
93950	Streamlight 2x Module 40 THETIS 35W HIT-TC-CE/GU6,5 S	550	2,480
93951	Streamlight 2x Module 40 THETIS 35W HIT-TC-CE/GU6,5 M	550	2,480
93952	Streamlight 2x Module 40 THETIS 35W HIT-TC-CE/GU6,5 W	550	2,480

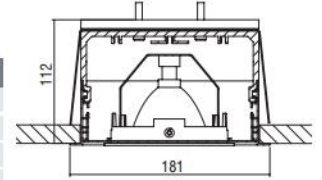

STREAMLIGHT + Module 40 HERCULES LED REFLECTOR

Module 40 HERCULES LED REFLECTOR

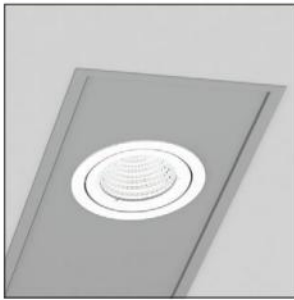

CE	F	850°C	IP 20
80°	350°		
LED	ta 25°C		Included

- Reflectors: Spot, Medium, Wide.
- 12W power consumption driven at 350mA.
- Efficiency:  
12W: 4000 K: 1758 Lumen, CRI: min. 80  
12W: 3000 K: 1680 Lumen, CRI: min. 80  
Maximum: 147 Lm/W

Code	Description	L	Kg
93953	Streamlight Module 40 HERCULES LED REFLECTOR 12W	350	1,580
93954	Streamlight 2x Module 40 HERCULES LED REFLECTOR 12W	550	2,480

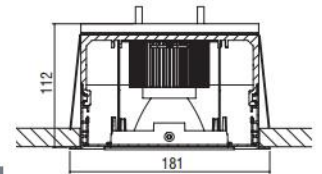

STREAMLIGHT + Module 40 IASON LED REFLECTOR HO

Module 40 IASON LED REFLECTOR HO

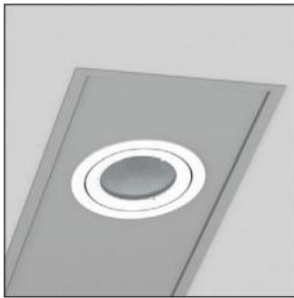

CE	F	850°C	IP 20
80°	350°		
LED	ta 25°C		Included

- Reflectors: Spot, Medium, Wide.
- 12W power consumption driven at 350mA.
- Efficiency:  
12W: 4000 K: 1758 Lumen, CRI: min. 80  
12W: 3000 K: 1680 Lumen, CRI: min. 80  
Maximum: 147 Lm/W

Code	Description	L	Kg
93955	Streamlight Module 40 IASON LED REFLECTOR HO 12W	350	1,580
93956	Streamlight 2x Module 40 IASON LED REFLECTOR HO 12W	550	2,480

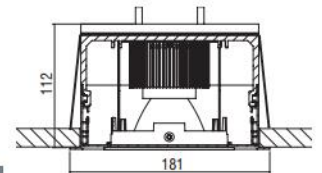

LED COLOUR CODES:

2 Warm 3 Neutral

BEAM CODES:

01 spot 02 medium 03 wide 04 spot HO 05 medium HO 06 wide HO

Colour Codes:

0 Colours 1 White 2 Titan 3 Black 5 matt Alum. 9 Anodized

STREAMLIGHT ACCESSORIES

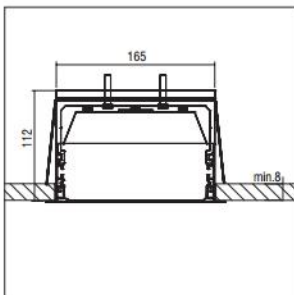

CE			
----	--	--	--

- Metal suspension bracket.
- Required 1pc per 0,5m profile length.

Code	Description	Kg
900720	Suspension Bracket Streamlight	0,270



## HIGH SYSTEM FRAME

*The unique anaglyph frame gives HIGH SYSTEM FRAME a strong architectural identity. This, in combination with the perfect lighting conditions without annoying reflections, make this luminaire suitable for many different working areas (offices, houses, entrance areas etc).*

*Uniformly illuminated lines with no dark shadows can be created thanks to the Seamless version of T16 fluorescent lamps.*

*The LED version escapes also the restrictions of the T16 fluorescent lamps, by using LED lighting points that can have any spacing pitch, and this gives the light line enormous flexibility.*

*The visual benefit: The continuous-row system is illuminated absolutely uniformly from beginning to end, is economically efficient, maintenance free and it has long service-life.*

### Technical Features

- Housing from aluminium profile, painted electrostatically in selected colour.
- High efficient diffuser in opal PMMA.
- Flow recuperator in white colour.

#### Upon request

- Connection for operation with electronic dimmable ballast.

#### For LED Version

- Pure light without IR/UV radiation.
- Efficient thermal management.
- Up to 27W/m and 3620 Lm luminous flux range.
- Operation life: 50,000 hours with efficiency > 70% of the initial luminous flux.
- Connection for operation on 230V/50Hz.

#### Upon request:

Available with highest colour rendering index (CRI)

HIGH SYSTEM FRAME

HIGH SYSTEM FRAME

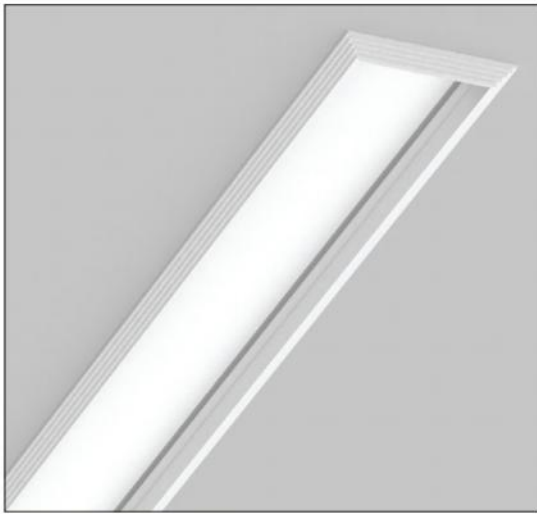

- Version for T16 and T16 SEAMLESS.
- Aluminium body.
- High efficient diffuser in opal PMMA.
- Flow recuperator in white colour.
- Suspension and power supply not included.

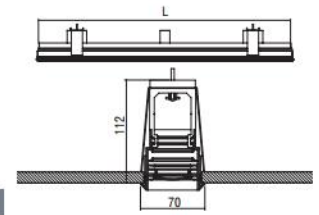

Code	Description	L	Kg
98801	High System Frame 1x13/14W T16	620	1,480
98803	High System Frame 1x20/24W T16	620	1,480
98805	High System Frame 1x19/21W T16	920	2,200
98807	High System Frame 1x34/39W T16	920	2,200
98809	High System Frame 1x25/28W T16	1220	2,920
98811	High System Frame 1x50/54W T16	1220	2,920
98813	High System Frame 1x32/35W T16	1520	3,640
98815	High System Frame 1x45/49W T16	1520	3,640
98817	High System Frame 1x73/80W T16	1520	3,640
98837	High System Frame 1x14W SEAMLESS	620	1,480
98839	High System Frame 1x24W SEAMLESS	620	1,480
98841	High System Frame 1x21W SEAMLESS	920	2,200
98843	High System Frame 1x39W SEAMLESS	920	2,200
98845	High System Frame 1x28W SEAMLESS	1220	2,920
98847	High System Frame 1x54W SEAMLESS	1220	2,920
98853	High System Frame 1+1x21W SEAMLESS	1725	3,610
98855	High System Frame 1+1x39W SEAMLESS	1725	3,610
98857	High System Frame 1+1x28W SEAMLESS	2045	4,280
98859	High System Frame 1+1x54W SEAMLESS	2045	4,280

Hole		
1x13/14W - 20/24W T16	63 x 614	
1x19/21W - 34/39W T16	63 x 914	
1x25/28W - 50/54W T16	63 x 1214	
1x32/35W - 45/49W T16	63 x 1514	
1x73/80W T16	63 x 1514	
1x14 - 24W T16 SLS	63 x 614	
1x21 - 39W T16 SLS	63 x 914	
1x28 - 54W T16 SLS	63 x 1214	
1+1x21W - 39W T16 SLS	63 x 1719	
1+1x28W - 54W T16 SLS	63 x 2039	

CE IP 20  
43

T16 SEAMLESS  
CORONA TO PHILIPS T16 CORONA SEAMLESS

Included

HIGH SYSTEM FRAME LED



- Version for LED CHIP.
- Aluminium body.
- High efficient diffuser in opal PMMA.
- Flow recuperator in white colour.
- Suspension and power supply not included.
- Efficiency: 145 Lumen / Watt.

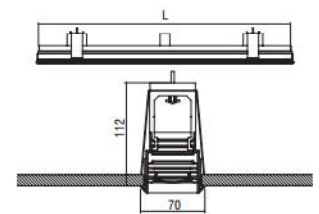

Code	Description	L	Kg
98873	High System Frame Led 15W 2170 lm Neutral	620	1,480
98874	High System Frame Led 23W 3260 lm Neutral	900	2,150
98875	High System Frame Led 30W 4330 lm Neutral	1180	2,820
98876	High System Frame Led 38W 5430 lm Neutral	1460	3,490
98877	High System Frame Led 15W 1990 lm Warm	620	1,480
98878	High System Frame Led 23W 2990 lm Warm	900	2,150
98879	High System Frame Led 30W 3980 lm Warm	1180	2,820
98880	High System Frame Led 38W 4980 lm Warm	1460	3,490

Hole		
15W	63 x 614	
23W	63 x 894	
30W	63 x 1174	
38W	63 x 1454	

CE IP 20  
43

LED ta 25°C

Colour Codes:

0	Colours	1	White	2	Titan	3	Black	5	matt Alum.
---	---------	---	-------	---	-------	---	-------	---	------------

**HIGH SYSTEM FRAME**

**HIGH SYSTEM FRAME + Module 30**



- Version for LED CHIP.
- Aluminium body.
- Lens in Spot, Medium, Wide or spot reflector selection.
- Efficiency: 107 Lumen / Watt.

Code	Description	L	Kg
98901	High System Frame Module 30 1x2W Lens	250	0,530
98902	High System Frame Module 30 2x2W Lens	330	0,700
98903	High System Frame Module 30 3x2W Lens	410	0,870
98904	High System Frame Module 30 1x2W Reflector	250	0,530
98905	High System Frame Module 30 2x2W Reflector	330	0,700
98906	High System Frame Module 30 3x2W Reflector	410	0,870

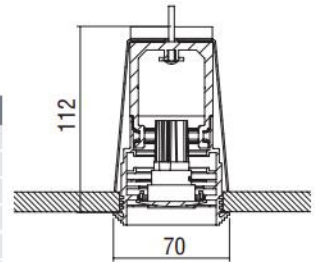

CE	F		IP 20
Co	Co		
▲	▲	▲	
LED	100% CFL REPLACE	ta 25°C	Included 

**LED COLOUR CODES:**

**2** Warm **3** Neutral

**BEAM CODES:**

**01** spot **02** medium **03** wide

**Colour Codes:**

**0** Colours **1** White **2** Titan **3** Black **5** matt Alum.

**HIGH SYSTEM FRAME ACCESSORIES**

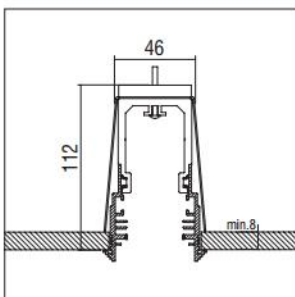

CE			

- Metal suspension bracket.
- Required 1pc per 1m profile length.

Code	Description	Kg
900280	Suspension Bracket High System Frame	0,470



**SLOTLIGHT FRAME**

---

*The unique anaglyph frame gives SLOTLIGHT FRAME a strong architectural identity. This, in combination with the perfect lighting conditions without annoying reflections, make this luminaire suitable for many different working areas (offices, houses, entrance areas etc).*

*Uniformly illuminated lines with no dark shadows can be created thanks to the "tetris" installation of the T16 fluorescent lamps.*

*The LED version escapes the restrictions of the T16 fluorescent lamps, by using LED lighting points that can have any spacing pitch, and this gives the light line enormous flexibility. The visual benefit: The continuous-row system is illuminated absolutely uniformly from beginning to end, is economically efficient, maintenance free and it has long service-life.*

**Technical Features**

---

- Housing from aluminium profile, painted electrostatically in selected colour.
- High efficient diffuser in opal PMMA.
- Flow recuperator in white colour.

**Upon request**

- Connection for operation with electronic dimmable ballast.

**For LED Version**

- Pure light without IR/UV radiation.
- Efficient thermal management.
- Up to 28W/m and 3864 Lm luminous flux range.
- Operation life: 50,000 hours with efficiency > 70% of the initial luminous flux.
- Connection for operation on 230V/50Hz.

**Upon request:**

Available with highest colour rendering index (CRI)



SLOTLIGHT FRAME

SLOTLIGHT FRAME



- Version for T16.
- Aluminium body.
- High efficient diffuser in opal PMMA.
- Flow recuperator in white colour.
- Suspension brackets not included.

Code	Description	L	Kg
92501	Slotlight Frame 1x13/14W T16	610	1,700
92503	Slotlight Frame 1x20/24W T16	610	1,700
92505	Slotlight Frame 1x19/21W T16	910	2,900
92507	Slotlight Frame 1x34/39W T16	910	2,900
92509	Slotlight Frame 1x25/28W T16	1210	3,400
92511	Slotlight Frame 1x50/54W T16	1210	3,400
92513	Slotlight Frame 1x32/35W T16	1510	4,250
92515	Slotlight Frame 1x45/49W T16	1510	4,250
92517	Slotlight Frame 1x73/80W T16	1510	4,250
92537	Slotlight Frame 2x13/14W T16	610	1,700
92539	Slotlight Frame 2x20/24W T16	610	1,700
92541	Slotlight Frame 2x19/21W T16	910	2,900
92543	Slotlight Frame 2x34/39W T16	910	2,900
92545	Slotlight Frame 2x25/28W T16	1210	3,400
92547	Slotlight Frame 2x50/54W T16	1210	3,400
92549	Slotlight Frame 2x32/35W T16	1510	4,250
92551	Slotlight Frame 2x45/49W T16	1510	4,250
92553	Slotlight Frame 2x73/80W T16	1510	4,250
92523	Slotlight Frame 1+1x19/21W T16	1675	4,700
92525	Slotlight Frame 1+1x34/39W T16	1675	4,700
92527	Slotlight Frame 1+1x25/28W T16	2275	6,400
92529	Slotlight Frame 1+1x50/54W T16	2275	6,400
92531	Slotlight Frame 1+1x32/35W T16	2875	8,050
92533	Slotlight Frame 1+1x45/49W T16	2875	8,050
92535	Slotlight Frame 1+1x73/80W T16	2875	8,050
92559	Slotlight Frame 2+2x19/21W T16	1885	5,280
92561	Slotlight Frame 2+2x34/39W T16	1885	5,280
92563	Slotlight Frame 2+2x25/28W T16	2485	7,000
92565	Slotlight Frame 2+2x50/54W T16	2485	7,000
92567	Slotlight Frame 2+2x32/35W T16	3085	8,650
92569	Slotlight Frame 2+2x45/49W T16	3085	8,650
92571	Slotlight Frame 2+2x73/80W T16	3085	8,650

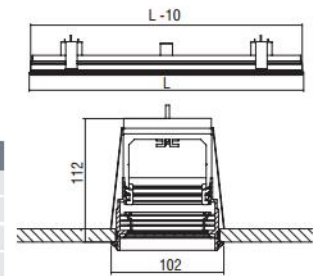

Hole

1-2x13/14W - 20/24W T16	95 x 604
1-2x19/21W - 34/39W T16	95 x 904
1-2x25/28W - 50/54W T16	95 x 1204
1-2x32/35W - 45/49W T16	95 x 1504
1-2x73/80W T16	95 x 1504
1+1x19/21W - 34/39W T16	95 x 1669
1+1x25/28W - 50/54W T16	95 x 2269
1+1x32/35W - 45/49W T16	95 x 2869
1+1x73/80W T16	95 x 2869
2+2x19/21W - 34/39W T16	95 x 1879
2+2x25/28W - 50/54W T16	95 x 2479
2+2x32/35W - 45/49W T16	95 x 3079
2+2x73/80W T16	95 x 3079

CE F IP 20 43

SEAMLESS

T16

SEAMLESS

Included

SLOTLIGHT FRAME LED



CE F IP 20 43

LED

ta 25°C

Included

- Version for LED CHIP.
- Aluminium body.
- High efficient diffuser in opal PMMA.
- Flow recuperator in white colour.
- Suspension brackets not included.
- Efficiency: max.138 Lumen / Watt.

Code	Description	L	Kg
92573	Slotlight Frame Led 16W 2200 lm Neutral	620	1,750
92574	Slotlight Frame Led 28W 3100 lm Neutral	1180	3,310
92575	Slotlight Frame Led 33W 4400 lm Neutral	1180	3,310
92576	Slotlight Frame Led 42W 4650 lm Neutral	1740	4,900
92577	Slotlight Frame Led 49W 6600 lm Neutral	1740	4,900
92578	Slotlight Frame Led 56W 6200 lm Neutral	2300	6,450
92579	Slotlight Frame Led 65W 8800 lm Neutral	2300	6,450
92580	Slotlight Frame Led 16W 2200 lm Warm	620	1,750
92582	Slotlight Frame Led 33W 4400 lm Warm	1180	3,310
92584	Slotlight Frame Led 49W 6600 lm Warm	1740	4,900
92586	Slotlight Frame Led 65W 8800 lm Warm	2300	6,450

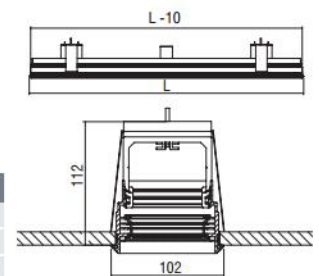

Hole

16W	95 x 614
28W - 33W	95 x 1174
42W - 49W	95 x 1734
56W - 65W	95 x 2294

Colour Codes:

- 0 Colours 1 White 2 Titan 3 Black 5 matt Alum.

SLOTLIGHT FRAME

SLOTLIGHT FRAME ANAGLYPH



- Version for T16.
- Aluminium body.
- Diffuser in opal of 10mm PMMA.
- Flow recuperator in white colour.
- Suspension brackets not included.

Code	Description	L	Kg
92601	Slotlight Frame Anaglyph 1x13/14W T16	610	2,100
92603	Slotlight Frame Anaglyph 1x20/24W T16	610	2,100
92605	Slotlight Frame Anaglyph 1x19/21W T16	910	3,140
92607	Slotlight Frame Anaglyph 1x34/39W T16	910	3,140
92609	Slotlight Frame Anaglyph 1x25/28W T16	1210	4,170
92611	Slotlight Frame Anaglyph 1x50/54W T16	1210	4,170
92613	Slotlight Frame Anaglyph 1x32/35W T16	1510	5,200
92615	Slotlight Frame Anaglyph 1x45/49W T16	1510	5,200
92617	Slotlight Frame Anaglyph 1x73/80W T16	1510	5,200
92637	Slotlight Frame Anaglyph 2x13/14W T16	610	2,100
92639	Slotlight Frame Anaglyph 2x20/24W T16	610	2,100
92641	Slotlight Frame Anaglyph 2x19/21W T16	910	3,140
92643	Slotlight Frame Anaglyph 2x34/39W T16	910	3,140
92645	Slotlight Frame Anaglyph 2x25/28W T16	1210	4,170
92647	Slotlight Frame Anaglyph 2x50/54W T16	1210	4,170
92649	Slotlight Frame Anaglyph 2x32/35W T16	1510	5,200
92651	Slotlight Frame Anaglyph 2x45/49W T16	1510	5,200
92653	Slotlight Frame Anaglyph 2x73/80W T16	1510	5,200
92623	Slotlight Frame Anaglyph 1 + 1x19/21W T16	1675	5,770
92625	Slotlight Frame Anaglyph 1 + 1x34/39W T16	1675	5,770
92627	Slotlight Frame Anaglyph 1 + 1x25/28W T16	2275	7,830
92629	Slotlight Frame Anaglyph 1 + 1x50/54W T16	2275	7,830
92631	Slotlight Frame Anaglyph 1 + 1x32/35W T16	2875	9,890
92633	Slotlight Frame Anaglyph 1 + 1x45/49W T16	2875	9,890
92635	Slotlight Frame Anaglyph 1 + 1x73/80W T16	2875	9,890
92659	Slotlight Frame Anaglyph 2 + 2x19/21W T16	1885	6,490
92661	Slotlight Frame Anaglyph 2 + 2x34/39W T16	1885	6,490
92663	Slotlight Frame Anaglyph 2 + 2x25/28W T16	2485	8,550
92665	Slotlight Frame Anaglyph 2 + 2x50/54W T16	2485	8,550
92667	Slotlight Frame Anaglyph 2 + 2x32/35W T16	3085	10,620
92669	Slotlight Frame Anaglyph 2 + 2x45/49W T16	3085	10,620
92671	Slotlight Frame Anaglyph 2 + 2x73/80W T16	3085	10,620

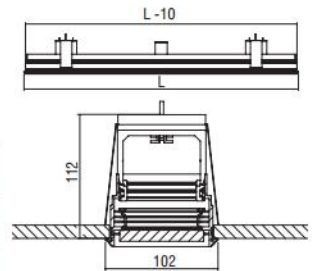

Hole

1-2x13/14W - 20/24W T16	95 x 604
1-2x19/21W - 34/39W T16	95 x 904
1-2x25/28W - 50/54W T16	95 x 1204
1-2x32/35W - 45/49W T16	95 x 1504
1-2x73/80W T16	95 x 1504
1+1x19/21W - 34/39W T16	95 x 1669
1+1x25/28W - 50/54W T16	95 x 2269
1+1x32/35W - 45/49W T16	95 x 2869
1+1x73/80W T16	95 x 2869
2+2x19/21W - 34/39W T16	95 x 1879
2+2x25/28W - 50/54W T16	95 x 2479
2+2x32/35W - 45/49W T16	95 x 3079
2+2x73/80W T16	95 x 3079

CE F IP 43

EN 60598-2-15

T16

OPRANE 15 PHILIPS T16

Included

SLOTLIGHT FRAME ANAGLYPH LED



CE F IP 20 43

EN 60598-2-15

LED

WALL MOUNT CURRENT

ta 25°C

Included

- Version for LED CHIP.
- Aluminium body.
- Diffuser in opal of 10mm PMMA.
- Flow recuperator in white colour.
- Suspension brackets not included.
- Efficiency: max.138 Lumen / Watt.

Code	Description	L	Kg
92673	Slotlight Frame Anaglyph Led 16W 2200 lm Neutral	620	2,140
92674	Slotlight Frame Anaglyph Led 28W 3100 lm Neutral	1180	4,060
92675	Slotlight Frame Anaglyph Led 33W 4400 lm Neutral	1180	4,060
92676	Slotlight Frame Anaglyph Led 42W 4650 lm Neutral	1740	5,990
92677	Slotlight Frame Anaglyph Led 49W 6600 lm Neutral	1740	5,990
92678	Slotlight Frame Anaglyph Led 56W 6200 lm Neutral	2300	7,920
92679	Slotlight Frame Anaglyph Led 65W 8800 lm Neutral	2300	7,920
92680	Slotlight Frame Anaglyph Led 16W 2200 lm Warm	620	2,140
92682	Slotlight Frame Anaglyph Led 33W 4400 lm Warm	1180	4,060
92684	Slotlight Frame Anaglyph Led 49W 6600 lm Warm	1740	5,990
92686	Slotlight Frame Anaglyph Led 65W 8800 lm Warm	2300	7,920

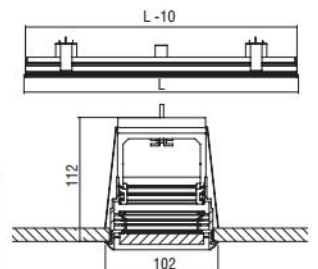

Hole

16W	95 x 614
28W - 33W	95 x 1174
42W - 49W	95 x 1734
56W - 65W	95 x 2294

Colour Codes:

- 0 Colours 1 White 2 Titan 3 Black 5 matt Alum.

SLOTLIGHT FRAME

SLOTLIGHT FRAME LOUVRE



- Version for T16.
- Aluminium body.
- Parabolic reflector in specular anodized aluminium.
- Suspension brackets not included.

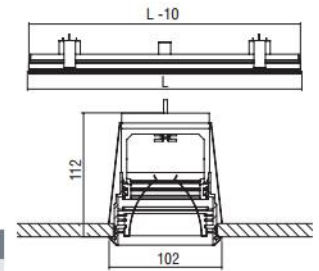

Code	Description	L	Kg
94303	Slotlight Frame Louvre 1x20/24W T16	610	1,300
94307	Slotlight Frame Louvre 1x34/39W T16	910	1,950
94311	Slotlight Frame Louvre 1x50/54W T16	1210	2,580
94315	Slotlight Frame Louvre 1x45/49W T16	1510	3,220
94317	Slotlight Frame Louvre 1x73/80W T16	1510	3,220
94325	Slotlight Frame Louvre 1+1x34/39W T16	1786	3,800
94329	Slotlight Frame Louvre 1+1x50/54W T16	2386	6,050
94333	Slotlight Frame Louvre 1+1x45/49W T16	2986	6,360
94335	Slotlight Frame Louvre 1+1x73/80W T16	2986	6,360

Hole	
1x20/24W T16	95 x 604
1x34/39W T16	95 x 904
1x50/54W T16	95 x 1204
1x45/49W - 73/80W T16	95 x 1504
1+1x34/39W T16	95 x 1780
1+1x50/54W T16	95 x 2380
1+1x45/49W - 73/80W T16	95 x 2980

CE	F	IP 20
T16		
OSRAM: T5 PHILIPS: T16		
	Included	

**Colour Codes:**

0	Colours	1	White	2	Titan	3	Black	5	matt Alum.
---	---------	---	-------	---	-------	---	-------	---	------------

SLOTLIGHT FRAME

SLOTLIGHT FRAME + Module 50 G5.3



CE	F	850°C	IP 20
25°	350°		
OSRAM Sylvania Philips			
		12V	

- Simple version for incandescent halogen max.50W 12V (QR-CBC 51).

Code	Description	L	Kg
95204	Slotlight Frame Module 50 1x max.50W/G5,3	300	1,270
95205	Slotlight Frame Module 50 2x max.50W/G5,3	450	1,900

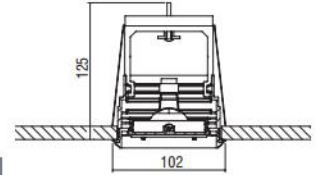

SLOTLIGHT FRAME + Module 50 GU10



CE	F	850°C	IP 20
30°	350°		
PAR 16	LED	FLUO	

- Simple version for incandescent halogen max.50W 230V (PAR16).

Code	Description	L	Kg
95201	Slotlight Frame Module 50 1x max.50W/GU10	170	0,720
95202	Slotlight Frame Module 50 2x max.50W/GU10	250	1,050

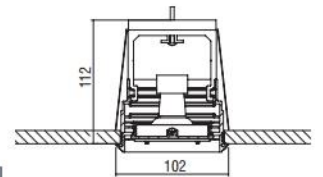

SLOTLIGHT FRAME + Module 50 IRA 2 Reflector



CE	F	850°C	IP 20
25°	350°		
LED	350mA	ta 25°C	

- Reflectors: Medium, Wide.  
 - 7W power consumption driven at 350mA.  
 - Efficiency:  
 4000 K: 770 Lumen, CRI: min. 80  
 3000 K: 730 Lumen, CRI: min. 80  
 Maximum: 110 Lm/W

Code	Description	L	Kg
95207	Slotlight Frame Module 50 1x IRA 2 7W Reflector	300	1,270
95208	Slotlight Frame Module 50 2x IRA 2 7W Reflector	450	1,900

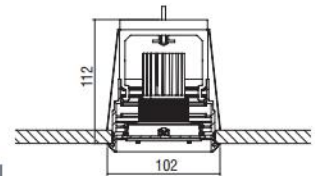

SLOTLIGHT FRAME + Module 50 DIMITRA 2 Reflector HO



CE	F	850°C	IP 40
25°	350°		
LED	500mA	ta 25°C	

- Reflectors: Spot, Medium, Wide.  
 - 5W power consumption driven at 500mA.  
 - Efficiency:  
 5W: 4000 K: 510 Lumen, CRI: min. 80  
 5W: 3000 K: 485 Lumen, CRI: min. 80  
 Maximum: 102 Lm/W

Code	Description	L	Kg
95209	Slotlight Frame Module 50 1x DIMITRA 2 5W Ref.HO	300	1,270
95210	Slotlight Frame Module 50 2x DIMITRA 2 5W Ref.HO	450	1,900

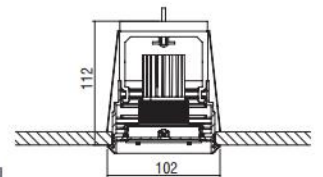

SLOTLIGHT FRAME + Module 50 ARTEMIS 2 Diffuser Prismatic



CE	F	850°C	IP 40
25°	350°		
D	LED	350/500mA	ta 25°C

- Beam: Diffuser.  
 - 5W power consumption driven at 500mA.  
 - 7W power consumption driven at 350mA.  
 - Efficiency:  
 5W: 4000 K: 510 Lumen, CRI: min. 80  
 5W: 3000 K: 485 Lumen, CRI: min. 80  
 7W: 4000 K: 770 Lumen, CRI: min. 80  
 7W: 3000 K: 730 Lumen, CRI: min. 80  
 Maximum: 110 Lm/W

Code	Description	L	Kg
95211	Slotlight Frame Module 50 1x ARTEMIS 2 5W Diffuser Prism.	300	1,270
95212	Slotlight Frame Module 50 2x ARTEMIS 2 5W Diffuser Prism.	450	1,900
95213	Slotlight Frame Module 50 1x ARTEMIS 2 7W Diffuser Prism.	300	1,270
95214	Slotlight Frame Module 50 2x ARTEMIS 2 7W Diffuser Prism.	450	1,900

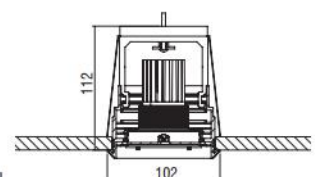

SLOTLIGHT FRAME

SLOTLIGHT FRAME + Module 50 ATHINA 2 Diffuser Opal



CE	F	850°C	IP 40
20°	350°		
D			
LED	5 YEAR WARRANTY	ta 25°C	350/500mA

- Beam: Diffuser.
- 5W power consumption driven at 500mA.
- 7W power consumption driven at 350mA.
- Efficiency:
  - 5W: 4000 K: 510 Lumen, CRI: min. 80
  - 5W: 3000 K: 485 Lumen, CRI: min. 80
  - 7W: 4000 K: 770 Lumen, CRI: min. 80
  - 7W: 3000 K: 730 Lumen, CRI: min. 80
- Maximum: 110 Lm/W

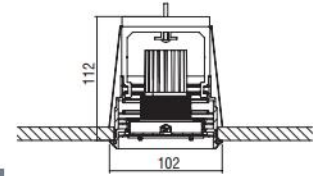

Code	Description	L	Kg
95215-00	Slotlight Frame Module 50 1x ATHINA 2 5W Diffuser Opal	300	1,270
95216-00	Slotlight Frame Module 50 2x ATHINA 2 5W Diffuser Opal	450	1,900
95217-00	Slotlight Frame Module 50 1x ATHINA 2 7W Diffuser Opal	300	1,270
95218-00	Slotlight Frame Module 50 2x ATHINA 2 7W Diffuser Opal	450	1,900

SLOTLIGHT FRAME + Module 50 VENUS 2 Lens



CE	F	850°C	IP 40
25°	350°		
LED	5 YEAR WARRANTY	ta 25°C	350/700mA

- Lens: Spot, Medium, Wide.
- 3W power consumption driven at 350mA.
- 6W power consumption driven at 700mA.
- Efficiency:
  - 3W: 4000 K: 321 Lumen, CRI: min. 75
  - 3W: 3000 K: 300 Lumen, CRI: min. 80
  - 6W: 4000 K: 600 Lumen, CRI: min. 75
  - 6W: 3000 K: 570 Lumen, CRI: min. 80
- Maximum: 107 Lm/W

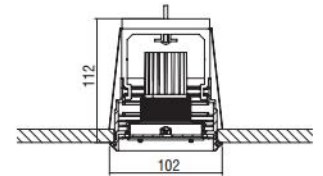

Code	Description	L	Kg
95219-00	Slotlight Frame Module 50 1x VENUS 2 3W/6W Lens	300	1,270
95220-00	Slotlight Frame Module 50 2x VENUS 2 3W/6W Lens	450	1,900

SLOTLIGHT FRAME + Module 30

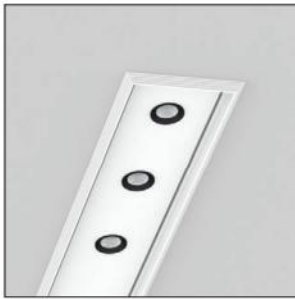

CE	F		IP 20
0°	360°		
LED	5 YEAR WARRANTY	ta 25°C	Included

- Version for LED CHIP.
- Aluminium body.
- Lens in Spot, Medium, Wide or spot reflector selection.

Code	Description	L	Kg
95221-00	Slotlight Frame Module 30 1x2W Lens	240	1,020
95222-00	Slotlight Frame Module 30 2x2W Lens	320	1,350
95223-00	Slotlight Frame Module 30 3x2W Lens	400	1,690
95224-01	Slotlight Frame Module 30 1x2W Reflector	240	1,020
95225-01	Slotlight Frame Module 30 2x2W Reflector	320	1,350
95226-01	Slotlight Frame Module 30 3x2W Reflector	400	1,690

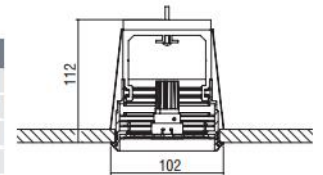

**LED COLOUR CODES:**

2	Warm	3	Neutral
---	------	---	---------

**BEAM CODES:**

01	spot	02	medium	03	wide
----	------	----	--------	----	------

**Colour Codes:**

0	Colours	1	White	2	Titan	3	Black	5	matte Alum.
---	---------	---	-------	---	-------	---	-------	---	-------------

SLOTLIGHT FRAME ACCESSORIES

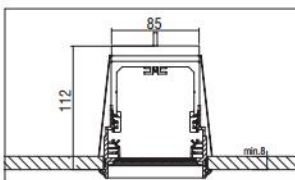

CE			
----	--	--	--

- Metal suspension bracket.
- Required 1pc per 1m profile length.

Code	Description	Kg
900210	Suspension Bracket Slotlight Frame	0,470

**STREAMLIGHT FRAME**

---

*The unique anaglyph frame gives STREAMLIGHT FRAME a strong architectural identity.*

*This, in combination with the perfect lighting conditions without annoying reflections, make this luminaire suitable for many different working areas (offices, houses, entrance areas etc).*

*Uniformly illuminated lines with no dark shadows can be created thanks to the "tetris" installation of the T16 fluorescent lamps.*

*The LED version escapes the restrictions of the T16 fluorescent lamps, by using LED lighting points that can have any spacing pitch, and this gives the light line enormous flexibility. The visual benefit: The continuous-row system is illuminated absolutely uniformly from beginning to end, is economically efficient, maintenance free and it has long service-life.*

**Technical Features**

---

- Housing from aluminium profile, painted electrostatically in selected colour.
- High efficient diffuser in opal PMMA.
- Flow recuperator in white colour.

**Upon request**

- Connection for operation with electronic dimmable ballast.

**For LED Version**

- Pure light without IR/UV radiation.
- Efficient thermal management.
- Up to 28W/m and 3864 Lm luminous flux range.
- Operation life: 50,000 hours with efficiency > 70% of the initial luminous flux.
- Connection for operation on 230V/50Hz.

**Upon request:**

Available with highest colour rendering index (CRI)

STREAMLIGHT FRAME

STREAMLIGHT FRAME TETRIS



- Version for T16.
- Aluminium body.
- High efficient diffuser in opal PMMA.
- Flow recuperator in white colour.
- Suspension brackets not included.

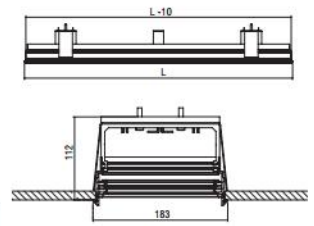

Code	Description	L	Kg
94437	Streamlight Frame Tetris 2x13/14W T16	610	2,140
94439	Streamlight Frame Tetris 2x20/24W T16	610	2,140
94441	Streamlight Frame Tetris 2x19/21W T16	910	3,190
94443	Streamlight Frame Tetris 2x34/39W T16	910	3,190
94445	Streamlight Frame Tetris 2x25/28W T16	1210	4,240
94447	Streamlight Frame Tetris 2x50/54W T16	1210	4,240
94449	Streamlight Frame Tetris 2x32/35W T16	1510	5,290
94451	Streamlight Frame Tetris 2x45/49W T16	1510	5,290
94453	Streamlight Frame Tetris 2x73/80W T16	1510	5,290
94463	Streamlight Frame Tetris 2+2x25/28W T16	2275	7,970
94465	Streamlight Frame Tetris 2+2x50/54W T16	2275	7,970
94467	Streamlight Frame Tetris 2+2x32/35W T16	2875	10,070
94469	Streamlight Frame Tetris 2+2x45/49W T16	2875	10,070
94471	Streamlight Frame Tetris 2+2x73/80W T16	2875	10,070

Hole

2x13/14W - 20/24W T16	175 x 604
2x19/21W - 34/39W T16	175 x 904
2x25/28W - 50/54W T16	175 x 1204
2x32/35W - 45/49W T16	175 x 1504
2x73/80W T16	175 x 1504
2+2x25/28W - 50/54W T16	175 x 2269
2+2x32/35W - 45/49W T16	175 x 2869
2+2x73/80W T16	175 x 2869



STREAMLIGHT FRAME LED



- Version for LED CHIP.
- Aluminium body.
- High efficient diffuser in opal PMMA.
- Flow recuperator in white colour.
- Suspension brackets not included.
- Efficiency: max.138 Lumen / Watt.

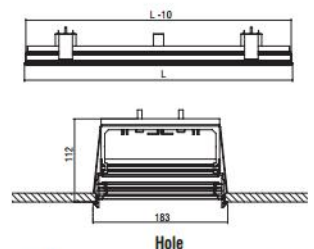

Code	Description	L	Kg
94473	Streamlight Frame Led 16W 2200 lm Neutral	620	2,170
94474	Streamlight Frame Led 33W 4400 lm Neutral	1180	4,130
94475	Streamlight Frame Led 49W 6600 lm Neutral	1740	6,090
94476	Streamlight Frame Led 65W 8800 lm Neutral	2300	8,050
94477	Streamlight Frame Led 16W 2200 lm Warm	620	2,170
94478	Streamlight Frame Led 33W 4400 lm Warm	1180	4,130
94479	Streamlight Frame Led 49W 6600 lm Warm	1740	6,090
94480	Streamlight Frame Led 65W 8800 lm Warm	2300	8,050

Hole

16W	175 x 614
33W	175 x 1174
49W	175 x 1736
65W	175 x 2294



Colour Codes:

0 Colours 1 White 2 Titan 3 Black 5 matt Alum.

STREAMLIGHT FRAME

STREAMLIGHT FRAME ANAGLYPH



- Version for T16.
- Aluminium body.
- Diffuser in opal of 10mm PMMA.
- Flow recuperator in white colour.
- Suspension brackets not included.

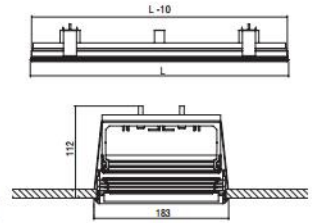

Code	Description	L	Kg
94537	Streamlight Frame Anaglyph 2x13/14W T16	610	3,090
94539	Streamlight Frame Anaglyph 2x20/24W T16	610	3,090
94541	Streamlight Frame Anaglyph 2x19/21W T16	910	4,610
94543	Streamlight Frame Anaglyph 2x34/39W T16	910	4,610
94545	Streamlight Frame Anaglyph 2x25/28W T16	1210	6,130
94547	Streamlight Frame Anaglyph 2x50/54W T16	1210	6,130
94549	Streamlight Frame Anaglyph 2x32/35W T16	1510	7,610
94551	Streamlight Frame Anaglyph 2x45/49W T16	1510	7,610
94553	Streamlight Frame Anaglyph 2x73/80W T16	1510	7,610
94563	Streamlight Frame Anaglyph 2+2x25/28W T16	2275	6,370
94565	Streamlight Frame Anaglyph 2+2x50/54W T16	2275	6,370
94567	Streamlight Frame Anaglyph 2+2x32/35W T16	2875	8,050
94569	Streamlight Frame Anaglyph 2+2x45/49W T16	2875	8,050
94571	Streamlight Frame Anaglyph 2+2x73/80W T16	2875	8,050

Hole		
2x13/14W - 20/24W T16	175 x	604
2x19/21W - 34/39W T16	175 x	904
2x25/28W - 50/54W T16	175 x	1204
2x32/35W - 45/49W T16	175 x	1504
2x73/80W T16	175 x	1504
2+2x25/28W - 50/54W T16	175 x	2269
2+2x32/35W - 45/49W T16	175 x	2869
2+2x73/80W T16	175 x	2869

CE F IP 20 43

T16

OSRAM: 15  
PHILIPS: 15.5

Included

STREAMLIGHT FRAME ANAGLYPH LED



- Version for LED CHIP.
- Aluminium body.
- Diffuser in opal of 10mm PMMA.
- Flow recuperator in white colour.
- Suspension brackets not included.
- Efficiency: max.138 Lumen / Watt.

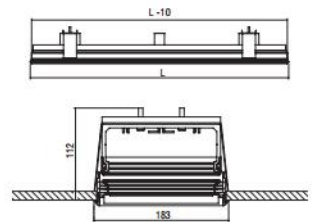

Code	Description	L	Kg
94573	Streamlight Frame Anaglyph Led 16W 2200 lm Neutral	620	3,140
94574	Streamlight Frame Anaglyph Led 33W 4400 lm Neutral	1180	5,970
94575	Streamlight Frame Anaglyph Led 49W 6600 lm Neutral	1740	8,810
94576	Streamlight Frame Anaglyph Led 65W 8800 lm Neutral	2300	11,640
94577	Streamlight Frame Anaglyph Led 16W 2200 lm Warm	620	3,140
94578	Streamlight Frame Anaglyph Led 33W 4400 lm Warm	1180	5,970
94579	Streamlight Frame Anaglyph Led 49W 6600 lm Warm	1740	8,810
94580	Streamlight Frame Anaglyph Led 65W 8800 lm Warm	2300	11,640

Hole		
16W	175 x	614
33W	175 x	1174
49W	175 x	1736
65W	175 x	2294

CE F IP 20 43

LED

ta 25°C

Included

Colour Codes:

- 0 Colours 1 White 2 Titan 3 Black 5 matt Alum.



STREAMLIGHT FRAME

STREAMLIGHT FRAME PLEXI OPAL CARRÉ



- Version for T16.
- Aluminium body.
- High efficient diffuser in opal PMMA.
- Flow recuperator in white colour.
- Suspension brackets not included.

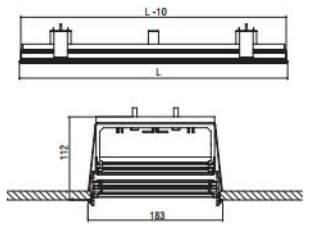

CE IP 20  
43

T16

OSRAM TO PHILIPS T16

Included

Code	Description	L	Kg
94737	Streamlight Frame Plexi Opal Carré 2x13/14W T16	610	2,140
94739	Streamlight Frame Plexi Opal Carré 2x20/24W T16	610	2,140
94741	Streamlight Frame Plexi Opal Carré 2x19/21W T16	910	3,190
94743	Streamlight Frame Plexi Opal Carré 2x34/39W T16	910	3,190
94745	Streamlight Frame Plexi Opal Carré 2x25/28W T16	1210	4,240
94747	Streamlight Frame Plexi Opal Carré 2x50/54W T16	1210	4,240
94749	Streamlight Frame Plexi Opal Carré 2x32/35W T16	1510	5,290
94751	Streamlight Frame Plexi Opal Carré 2x45/49W T16	1510	5,290
94753	Streamlight Frame Plexi Opal Carré 2x73/80W T16	1510	5,290
94763	Streamlight Frame Plexi Opal Carré 2+2x25/28W T16	2275	7,970
94765	Streamlight Frame Plexi Opal Carré 2+2x50/54W T16	2275	7,970
94767	Streamlight Frame Plexi Opal Carré 2+2x32/35W T16	2875	10,070
94769	Streamlight Frame Plexi Opal Carré 2+2x45/49W T16	2875	10,070
94771	Streamlight Frame Plexi Opal Carré 2+2x73/80W T16	2875	10,070

Hole

2x13/14W - 20/24W T16	175 x 604
2x19/21W - 34/39W T16	175 x 904
2x25/28W - 50/54W T16	175 x 1204
2x32/35W - 45/49W T16	175 x 1504
2x73/80W T16	175 x 1504
2+2x25/28W - 50/54W T16	175 x 2269
2+2x32/35W - 45/49W T16	175 x 2869
2+2x73/80W T16	175 x 2869

STREAMLIGHT FRAME PLEXI OPAL CARRÉ LED



- Version for LED CHIP.
- Aluminium body.
- High efficient diffuser in opal PMMA.
- Flow recuperator in white colour.
- Suspension brackets not included.
- Efficiency: max.138 Lumen / Watt.

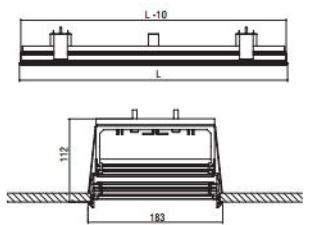

CE IP 20  
43

LED ta 25°C

Included

Code	Description	L	Kg
94773	Streamlight Frame Plexi Opal Carré Led 16W 2200 lm Neutral	620	2,170
94774	Streamlight Frame Plexi Opal Carré Led 33W 4400 lm Neutral	1180	4,130
94775	Streamlight Frame Plexi Opal Carré Led 49W 6600 lm Neutral	1740	6,090
94776	Streamlight Frame Plexi Opal Carré Led 65W 8800 lm Neutral	2300	8,050
94777	Streamlight Frame Plexi Opal Carré Led 16W 2200 lm Warm	620	2,170
94778	Streamlight Frame Plexi Opal Carré Led 33W 4400 lm Warm	1180	4,130
94779	Streamlight Frame Plexi Opal Carré Led 49W 6600 lm Warm	1740	6,090
94780	Streamlight Frame Plexi Opal Carré Led 65W 8800 lm Warm	2300	8,050

Hole

16W	175 x 614
33W	175 x 1174
49W	175 x 1736
65W	175 x 2294

Colour Codes:

0 Colours 1 White 2 Titan 3 Black 5 matt Alum.

STREAMLIGHT FRAME

STREAMLIGHT FRAME PLEXI OPAL DOUBLE

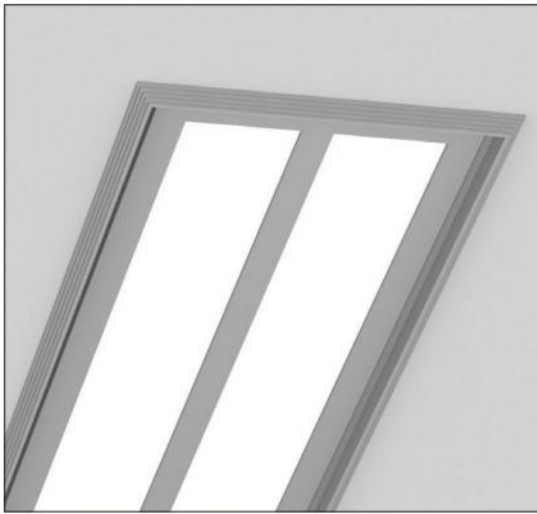

- Version for T16.
- Aluminium body.
- High efficient diffuser in opal PMMA.
- Flow recuperator in white colour.
- Suspension brackets not included.

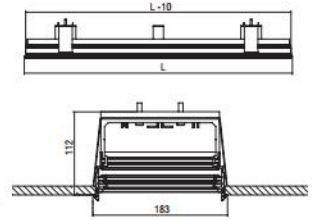

Code	Description	L	Kg
94837	Streamlight Frame Plexi Opal Double 2x13/14W T16	610	2,140
94839	Streamlight Frame Plexi Opal Double 2x20/24W T16	610	2,140
94841	Streamlight Frame Plexi Opal Double 2x19/21W T16	910	3,190
94843	Streamlight Frame Plexi Opal Double 2x34/39W T16	910	3,190
94845	Streamlight Frame Plexi Opal Double 2x25/28W T16	1210	4,240
94847	Streamlight Frame Plexi Opal Double 2x50/54W T16	1210	4,240
94849	Streamlight Frame Plexi Opal Double 2x32/35W T16	1510	5,290
94851	Streamlight Frame Plexi Opal Double 2x45/49W T16	1510	5,290
94853	Streamlight Frame Plexi Opal Double 2x73/80W T16	1510	5,290
94863	Streamlight Frame Plexi Opal Double 2+2x25/28W T16	2275	7,970
94865	Streamlight Frame Plexi Opal Double 2+2x50/54W T16	2275	7,970
94867	Streamlight Frame Plexi Opal Double 2+2x32/35W T16	2875	10,070
94869	Streamlight Frame Plexi Opal Double 2+2x45/49W T16	2875	10,070
94871	Streamlight Frame Plexi Opal Double 2+2x73/80W T16	2875	10,070

**Hole**

2x13/14W - 20/24W T16	175 x 604
2x19/21W - 34/39W T16	175 x 904
2x25/28W - 50/54W T16	175 x 1204
2x32/35W - 45/49W T16	175 x 1504
2x73/80W T16	175 x 1504
2+2x25/28W - 50/54W T16	175 x 2269
2+2x32/35W - 45/49W T16	175 x 2869
2+2x73/80W T16	175 x 2869

CE F IP 20 43

T16

OPAL: 15  
PLEXI: 15

Included

STREAMLIGHT FRAME PLEXI OPAL DOUBLE LED



- Version for LED CHIP.
- Aluminium body.
- High efficient diffuser in opal PMMA.
- Flow recuperator in white colour.
- Suspension brackets not included.
- Efficiency: max.138 Lumen / Watt.

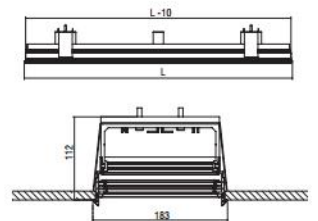

Code	Description	L	Kg
94873	Streamlight Frame Plexi Opal Double Led 16W 2200 lm Neutral	620	2,170
94874	Streamlight Frame Plexi Opal Double Led 33W 4400 lm Neutral	1180	4,130
94875	Streamlight Frame Plexi Opal Double Led 49W 6600 lm Neutral	1740	6,090
94876	Streamlight Frame Plexi Opal Double Led 65W 8800 lm Neutral	2300	8,050
94877	Streamlight Frame Plexi Opal Double Led 16W 2200 lm Warm	620	2,170
94878	Streamlight Frame Plexi Opal Double Led 33W 4400 lm Warm	1180	4,130
94879	Streamlight Frame Plexi Opal Double Led 49W 6600 lm Warm	1740	6,090
94880	Streamlight Frame Plexi Opal Double Led 65W 8800 lm Warm	2300	8,050

**Hole**

16W	175 x 614
33W	175 x 1174
49W	175 x 1736
65W	175 x 2294

CE F IP 20 43

LED

ta 25°C

Included

Colour Codes:

- 0 Colours 1 White 2 Titan 3 Black 5 matt Alum.

STREAMLIGHT FRAME

STREAMLIGHT FRAME LOUVRE



- Version for T16.
- Aluminium body.
- Parabolic reflector in specular anodized aluminium.
- Suspension brackets not included.

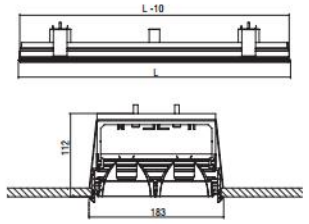

Code	Description	L	Kg
94637	Streamlight Frame Louvre 2x13/14W T16	610	2,100
94639	Streamlight Frame Louvre 2x20/24W T16	610	2,100
94641	Streamlight Frame Louvre 2x19/21W T16	910	3,130
94643	Streamlight Frame Louvre 2x34/39W T16	910	3,130
94645	Streamlight Frame Louvre 2x25/28W T16	1210	4,170
94647	Streamlight Frame Louvre 2x50/54W T16	1210	4,170
94649	Streamlight Frame Louvre 2x32/35W T16	1510	5,200
94651	Streamlight Frame Louvre 2x45/49W T16	1510	5,200
94653	Streamlight Frame Louvre 2x73/80W T16	1510	5,200
94663	Streamlight Frame Louvre 2 + 2x25/28W T16	2386	8,210
94665	Streamlight Frame Louvre 2 + 2x50/54W T16	2386	8,210
94667	Streamlight Frame Louvre 2 + 2x32/35W T16	2986	10,280
94669	Streamlight Frame Louvre 2 + 2x45/49W T16	2986	10,280
94671	Streamlight Frame Louvre 2 + 2x73/80W T16	2986	10,280

Hole	
2x13/14W - 20/24W T16	175 x 604
2x19/21W - 34/39W T16	175 x 904
2x25/28W - 50/54W T16	175 x 1204
2x32/35W - 45/49W T16	175 x 1504
2x73/80W T16	175 x 1504
2 + 2x25/28W - 50/54W T16	175 x 2380
2 + 2x32/35W - 45/49W T16	175 x 2980
2 + 2x73/80W T16	175 x 2980

CE IP 43

T16

OSRAM: 19 PHILIPS: T16

Included

Colour Codes:

- 0 Colours 1 White 2 Titan 3 Black 5 matt Alum.

STREAMLIGHT FRAME

STREAMLIGHT FRAME + Module 60 POSIDON HI-PAR 111

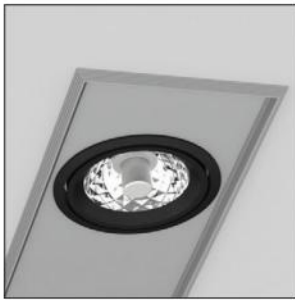

CE	850°C	IP 20
70°	350°	
OSRAM HI-PAR 111 PHILIPS COM-A 111		Included

- Version for HI-PAR 111/GX8,5.
- Outer adjustable ring from die-cast aluminium.
- Inner ring for easy lamp replacement.

Code	Description	L	Kg
95315	Streamlight Frame Module 60 POSIDON 35W HI-PAR 111/GX8,5	350	1,270
95316	Streamlight Frame Module 60 POSIDON 70W HI-PAR 111/GX8,5	350	1,270

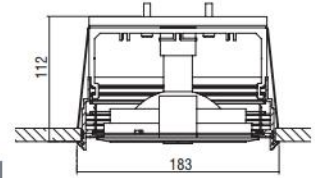

STREAMLIGHT FRAME + Module 60 DIONISOS QR111



CE	850°C	IP 20
70°	350°	
OSRAM HALOPOT 111 PHILIPS ALUMET 111		Included

- Version for QR111/G53.
- Outer adjustable ring from die-cast aluminium.
- Inner ring for easy lamp replacement.

Code	Description	L	Kg
95317	Streamlight Frame Module 60 DIONISOS max.70W QR111/G53	350	1,270

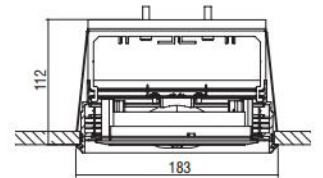

STREAMLIGHT FRAME + Module 60 APOLLON HIT-CE

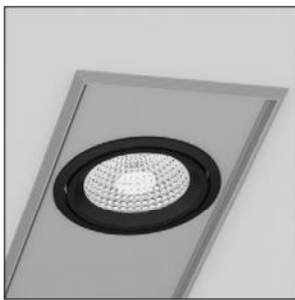

CE	850°C	IP 20
70°	350°	
OSRAM HIT-T PHILIPS COM-T		Included

- Version for HIT-CE/G12.
- Outer adjustable ring from die-cast aluminium.
- Inner ring for easy lamp replacement.
- High pure aluminium reflectors in Spot, Medium, Wide.
- Tempered protection glass.

Code	Description	L	Kg
95319	Streamlight Frame Module 60 APOLLON 35W HIT-CE/G12 S	350	1,270
95320	Streamlight Frame Module 60 APOLLON 35W HIT-CE/G12 M	350	1,270
95321	Streamlight Frame Module 60 APOLLON 35W HIT-CE/G12 W	350	1,270
95322	Streamlight Frame Module 60 APOLLON 70W HIT-CE/G12 S	350	1,270
95323	Streamlight Frame Module 60 APOLLON 70W HIT-CE/G12 M	350	1,270
95324	Streamlight Frame Module 60 APOLLON 70W HIT-CE/G12 W	350	1,270

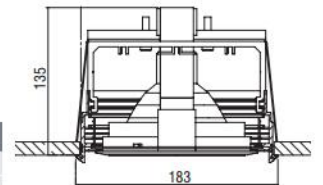

STREAMLIGHT FRAME + Module 60 IFESTOS HIT-TC-CE

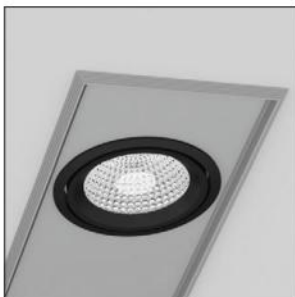

CE	850°C	IP 20
70°	350°	
OSRAM HIT-TC PHILIPS COM-TC		Included

- Version for HIT-TC-CE/G8,5.
- Outer adjustable ring from die-cast aluminium.
- Inner ring for easy lamp replacement.
- High pure aluminium reflectors in Spot, Medium, Wide.
- Tempered protection glass.

Code	Description	L	Kg
95325	Streamlight Frame Module 60 IFESTOS 35W HIT-TC-CE/G8,5 S	350	1,270
95326	Streamlight Frame Module 60 IFESTOS 35W HIT-TC-CE/G8,5 M	350	1,270
95327	Streamlight Frame Module 60 IFESTOS 35W HIT-TC-CE/G8,5 W	350	1,270
95328	Streamlight Frame Module 60 IFESTOS 70W HIT-TC-CE/G8,5 S	350	1,270
95329	Streamlight Frame Module 60 IFESTOS 70W HIT-TC-CE/G8,5 M	350	1,270
95330	Streamlight Frame Module 60 IFESTOS 70W HIT-TC-CE/G8,5 W	350	1,270

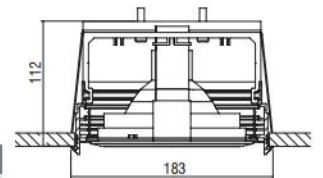

STREAMLIGHT FRAME

STREAMLIGHT FRAME + Module 60 ARIS LED R111

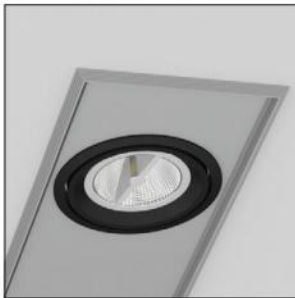

CE	F	850°C	IP 20
60°	350°		
LED			

- Version for LED R111/GU10.
- Outer adjustable ring from die-cast aluminium.
- Inner ring for easy lamp replacement.
- Connection for 230V/50Hz.

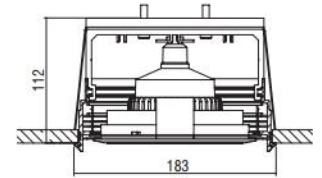

Code	Description	L	Kg
95318	Streamlight Frame Module 60 ARIS LED R111/GU10/230V	350	1,270

STREAMLIGHT FRAME + Module 60 DIAS LED

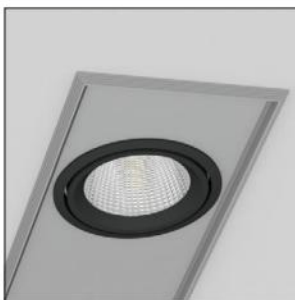

CE	F	850°C	IP 20
60°	350°		
LED	ta 25°C	Included	

- Version with LED Module.
  - Outer adjustable ring from die-cast aluminium.
  - 22W power consumption driven at 500mA.
  - 30W power consumption driven at 700mA.
  - Efficiency:
- |                   |         |                          |
|-------------------|---------|--------------------------|
| 22W:              | 4000 K: | 2440 Lumen, CRI: min. 80 |
| 22W:              | 3000 K: | 2331 Lumen, CRI: min. 80 |
| 30W:              | 4000 K: | 3290 Lumen, CRI: min. 80 |
| 30W:              | 3000 K: | 3143 Lumen, CRI: min. 80 |
| Maximum: 111 Lm/W |         |                          |

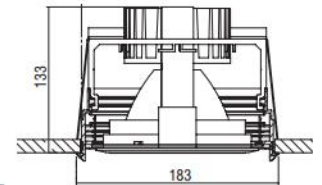

Code	Description	L	Kg
95331	Streamlight Frame Module 60 DIAS LED CHIP 22W	350	1,270
95332	Streamlight Frame Module 60 DIAS LED CHIP 30W	350	1,270

STREAMLIGHT FRAME + Module 60 KRONOS HIT-TC-CE



CE	F	850°C	IP 20
60°	350°		
HIT-TC-CE/GU6,5		Included	

- Version for HIT-TC-CE/GU6,5.
- Outer adjustable ring from die-cast aluminium.
- Die-cast aluminium spot inside.
- High pure aluminium reflectors in Spot, Medium, Wide.
- Tempered protection glass.

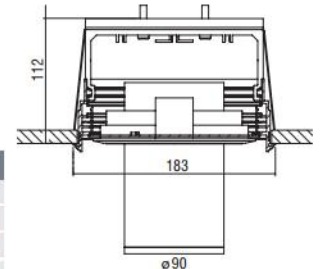

Code	Description	L	Kg
95333	Streamlight Frame Module 60 KRONOS 20W HIT-TC-CE/GU6,5 S	350	1,170
95334	Streamlight Frame Module 60 KRONOS 20W HIT-TC-CE/GU6,5 M	350	1,170
95335	Streamlight Frame Module 60 KRONOS 20W HIT-TC-CE/GU6,5 W	350	1,170
95336	Streamlight Frame Module 60 KRONOS 35W HIT-TC-CE/GU6,5 S	350	1,170
95337	Streamlight Frame Module 60 KRONOS 35W HIT-TC-CE/GU6,5 M	350	1,170
95338	Streamlight Frame Module 60 KRONOS 35W HIT-TC-CE/GU6,5 W	350	1,170

STREAMLIGHT FRAME + Module 60 KRONOS LED



CE	F	850°C	IP 20
60°	350°		
LED	ta 25°C	Included	

- Version with LED Module.
  - Outer adjustable ring from die-cast aluminium.
  - Die-cast aluminium spot inside.
  - 22W power consumption driven at 500mA.
  - Efficiency:
- |                   |         |                          |
|-------------------|---------|--------------------------|
| 22W:              | 4000 K: | 2440 Lumen, CRI: min. 80 |
| 22W:              | 3000 K: | 2331 Lumen, CRI: min. 80 |
| Maximum: 111 Lm/W |         |                          |

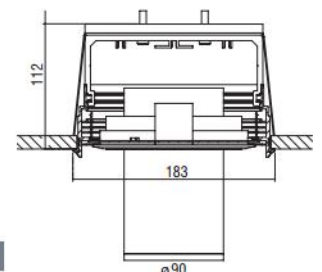

Code	Description	L	Kg
95339	Streamlight Frame Module 60 KRONOS LED CHIP 22W	350	1,170

STREAMLIGHT FRAME

STREAMLIGHT FRAME + Module 40 THETIS HIT-TC-CE

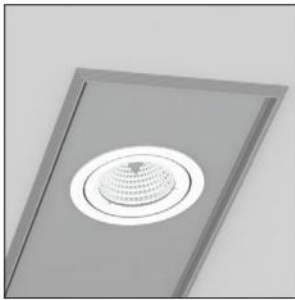

CE	IP 20		
80°	350°		
HIT-TC-CE/GU6,5			Included
OSRAM, HELIX, PHILIPS, COB Ltd			

- Version for HIT-TC-CE/GU6,5.
- Reflector: Spot, Medium, Wide.
- Tempered protection glass.

Code	Description	L	Kg
95341	Streamlight Frame Module 40 THETIS 20W HIT-TC-CE/GU6,5 S	350	1,270
95342	Streamlight Frame Module 40 THETIS 20W HIT-TC-CE/GU6,5 M	350	1,270
95343	Streamlight Frame Module 40 THETIS 20W HIT-TC-CE/GU6,5 W	350	1,270
95344	Streamlight Frame 2x Module 40 THETIS 20W HIT-TC-CE/GU6,5 S	550	1,990
95345	Streamlight Frame 2x Module 40 THETIS 20W HIT-TC-CE/GU6,5 M	550	1,990
95346	Streamlight Frame 2x Module 40 THETIS 20W HIT-TC-CE/GU6,5 W	550	1,990
95347	Streamlight Frame Module 40 THETIS 35W HIT-TC-CE/GU6,5 S	350	1,270
95348	Streamlight Frame Module 40 THETIS 35W HIT-TC-CE/GU6,5 M	350	1,270
95349	Streamlight Frame Module 40 THETIS 35W HIT-TC-CE/GU6,5 W	350	1,270
95350	Streamlight Frame 2x Module 40 THETIS 35W HIT-TC-CE/GU6,5 S	550	1,990
95351	Streamlight Frame 2x Module 40 THETIS 35W HIT-TC-CE/GU6,5 M	550	1,990
95352	Streamlight Frame 2x Module 40 THETIS 35W HIT-TC-CE/GU6,5 W	550	1,990

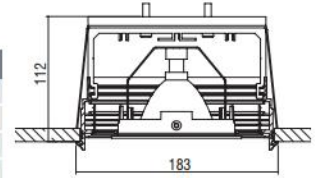

STREAMLIGHT FRAME + Module 40 HERCULES LED REFLECTOR

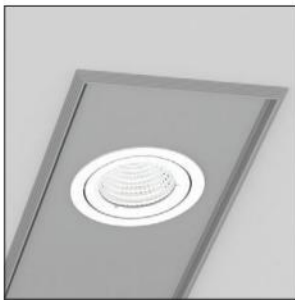

CE	IP 20	850°C	
80°	350°		
LED	ta 25°C		Included

- Reflectors: Spot, Medium, Wide.
- 12W power consumption driven at 350mA.
- Efficiency:  
12W: 4000 K: 1758 Lumen, CRI: min. 80  
12W: 3000 K: 1680 Lumen, CRI: min. 80  
Maximum: 147 Lm/W

Code	Description	L	Kg
95353	Streamlight Frame Module 40 HERCULES LED REFLECTOR 12W	350	1,270
95354	Streamlight Frame 2x Module 40 HERCULES LED REFLECTOR 12W	550	1,990

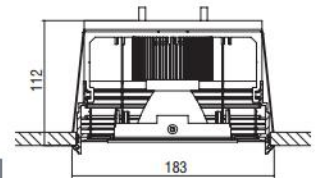

STREAMLIGHT FRAME + Module 40 IASON LED REFLECTOR HO



CE	IP 20	850°C	
80°	350°		
LED	ta 25°C		Included

- Reflectors: Spot, Medium, Wide.
- 12W power consumption driven at 350mA.
- Efficiency:  
12W: 4000 K: 1758 Lumen, CRI: min. 80  
12W: 3000 K: 1680 Lumen, CRI: min. 80  
Maximum: 147 Lm/W

Code	Description	L	Kg
95355	Streamlight Frame Module 40 IASON LED REFLECTOR HO 12W	350	1,270
95356	Streamlight Frame 2x Module 40 IASON LED REFLECTOR HO 12W	550	1,990

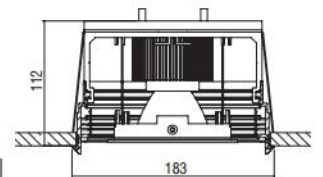

LED COLOUR CODES:

2 Warm 3 Neutral

BEAM CODES:

01 spot 02 medium 03 wide 04 spot HO 05 medium HO 06 wide HO

Colour Codes:

0 Colours 1 White 2 Titan 3 Black 5 matt Alum.

STREAMLIGHT FRAME ACCESSORIES

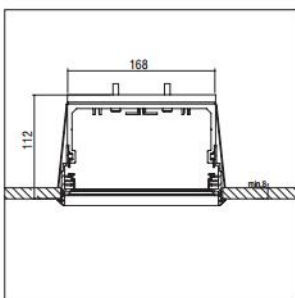

CE			
----	--	--	--

- Metal suspension bracket.
- Required 1pc per 0,5m profile length.

Code	Description	Kg
900720	Suspension Bracket Streamlight Frame	0,470



HIGH SYSTEM TRIMLESS

*The trimless version of HIGH SYSTEM, with the diffuser position deeper from the ceiling level, gives the impression of an almost immaterial luminaire fully integrated to the ceiling. This architectural advantage, in combination with the perfect lighting conditions without annoying reflections, make the Trimless High System suitable for many different working areas (offices, houses, entrance areas etc).*

*Uniformly illuminated lines with no dark shadows can be created thanks to the Seamless version of T16 fluorescent lamps. The LED version escapes also the restrictions of the T16 fluorescent lamps, by using LED lighting points that can have any spacing pitch, and this gives the light line enormous flexibility. The visual benefit: The continuous-row system is illuminated absolutely uniformly from beginning to end, is economically efficient, maintenance free and it has long service-life.*



Technical Features

- Housing from aluminium profile, painted electrostatically in selected colour.
- High efficient diffuser in opal PMMA.
- Flow recuperator in white colour.

**Upon request**

- Connection for operation with electronic dimmable ballast.

**For LED Version**

- Pure light without IR/UV radiation.
- Efficient thermal management.
- Up to 27W/m and 3620 Lm luminous flux range.
- Operation life: 50,000 hours with efficiency > 70% of the initial luminous flux.
- Connection for operation on 230V/50Hz.

**Upon request:**

Available with highest colour rendering index (CRI)



HIGH SYSTEM TRIMLESS

HIGH SYSTEM TRIMLESS

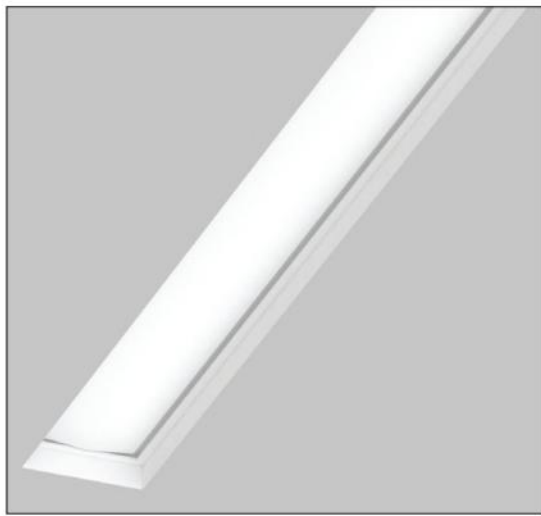

- Version for T16 and T16 SEAMLESS.
- Aluminium body.
- High efficient diffuser in opal PMMA.
- Flow recuperator in white colour.
- Suspension and power supply not included.

Code	Description	L	Kg
98801	High System Trimless 1x13/14W T16	620	2,170
98803	High System Trimless 1x20/24W T16	620	2,170
98805	High System Trimless 1x19/21W T16	920	3,220
98807	High System Trimless 1x34/39W T16	920	3,220
98809	High System Trimless 1x25/28W T16	1220	4,270
98811	High System Trimless 1x50/54W T16	1220	4,270
98813	High System Trimless 1x32/35W T16	1520	5,320
98815	High System Trimless 1x45/49W T16	1520	5,320
98817	High System Trimless 1x73/80W T16	1520	5,320
98837	High System Trimless 1x14W SEAMLESS	620	2,170
98839	High System Trimless 1x24W SEAMLESS	620	2,170
98841	High System Trimless 1x21W SEAMLESS	920	3,220
98843	High System Trimless 1x39W SEAMLESS	920	3,220
98845	High System Trimless 1x28W SEAMLESS	1220	4,270
98847	High System Trimless 1x54W SEAMLESS	1220	4,270
98853	High System Trimless 1+1x21W SEAMLESS	1725	6,040
98855	High System Trimless 1+1x39W SEAMLESS	1725	6,040
98857	High System Trimless 1+1x28W SEAMLESS	2045	7,160
98859	High System Trimless 1+1x54W SEAMLESS	2045	7,160

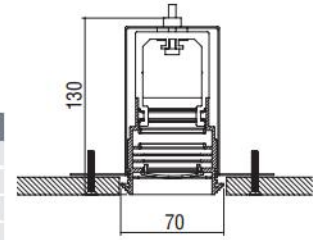

Hole	
1x13/14W - 20/24W T16	76 x 626
1x19/21W - 34/39W T16	76 x 926
1x25/28W - 50/54W T16	76 x 1226
1x32/35W - 45/49W T16	76 x 1526
1x73/80W T16	76 x 1526
1x14 - 24W T16 SLS	76 x 626
1x21 - 39W T16 SLS	76 x 926
1x28 - 54W T16 SLS	76 x 1226
1+1x21W - 39W T16 SLS	76 x 1731
1+1x28W - 54W T16 SLS	76 x 2051

CE IP 20  
43

T16 SEAMLESS  
SEAMLESS  
Included

HIGH SYSTEM TRIMLESS LED



- Version for LED CHIP.
- Aluminium body.
- High efficient diffuser in opal PMMA.
- Flow recuperator in white colour.
- Suspension and power supply not included.
- Efficiency: 145 Lumen / Watt.

Code	Description	Hole	L	Kg
98873	High System Trimless Led 15W 2170 lm Neutral	620	2,170	
98874	High System Trimless Led 23W 3260 lm Neutral	900	3,150	
98875	High System Trimless Led 30W 4330 lm Neutral	1180	4,130	
98876	High System Trimless Led 38W 5430 lm Neutral	1460	5,110	
98877	High System Trimless Led 15W 1990 lm Warm	620	2,170	
98878	High System Trimless Led 23W 2990 lm Warm	900	3,150	
98879	High System Trimless Led 30W 3980 lm Warm	1180	4,130	
98880	High System Trimless Led 38W 4980 lm Warm	1460	5,110	

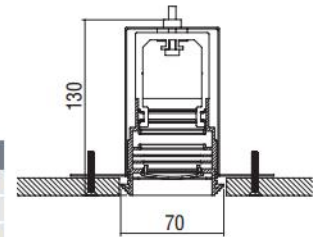

Hole	
15W	76 x 626
23W	76 x 906
30W	76 x 1186
38W	76 x 1466

CE IP 20  
43

LED ta 25°C

Colour Codes:  
0 Colours 1 White 2 Titan 3 Black

HIGH SYSTEM TRIMLESS

HIGH SYSTEM TRIMLESS + Module 30



- Version for LED CHIP.
- Aluminium body.
- Lens in Spot, Medium, Wide or spot reflector selection.
- Efficiency: 107 Lumen / Watt.

Code	Description	L	Kg
98901	High System Trimless Module 30 1x2W Lens	250	0,680
98902	High System Trimless Module 30 2x2W Lens	330	0,900
98903	High System Trimless Module 30 3x2W Lens	410	1,110
98904	High System Trimless Module 30 1x2W Reflector	250	0,680
98905	High System Trimless Module 30 2x2W Reflector	330	0,900
98906	High System Trimless Module 30 3x2W Reflector	410	1,110

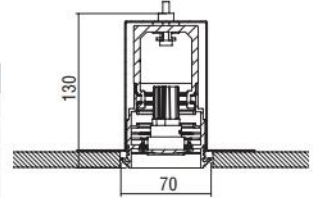

CE	△		IP 20
↻	↻		
▲	▲	▲	
LED	LED	ta 25°C	Included

**LED COLOUR CODES:**  
2 Warm 3 Neutral

**BEAM CODES:**  
01 spot 02 medium 03 wide

**Colour Codes:**  
0 Colours 1 White 2 Titan 3 Black

HIGH SYSTEM TRIMLESS ACCESSORIES

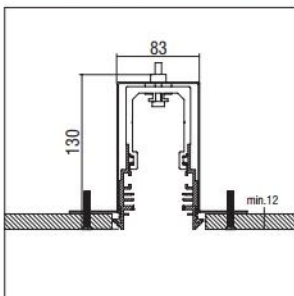

CE			

- Metal suspension bracket.
- Required 1pc per 1m profile length.

Code	Description	Kg
900270	Suspension Bracket High System Trimless	0,470

**HIGH SYSTEM SURFACE - TRIMLESS**

*The surface version with trimless view. Using the special suspension bracket for High or Low System profile get a unique option of a trimless profile. With the diffuser position in the same level with the ceiling, gives the impression of an almost immaterial luminaire fully integrated to the ceiling.*

*This architectural advantage, in combination with the perfect lighting conditions without annoying reflections, make the Trimless High System suitable for many different working areas (offices, houses, entrance areas etc).*

*Uniformly illuminated lines with no dark shadows can be created thanks to the Seamless version of T16 fluorescent lamps.*

*The LED version escapes also the restrictions of the T16 fluorescent lamps, by using LED lighting points that can have any spacing pitch and this gives the light line enormous flexibility. The visual benefit: The continuous-row system is illuminated absolutely uniformly from beginning to end, is economically efficient, maintenance free and it has long service-life.*

**HIGH SYSTEM SURFACE - TRIMLESS ACCESSORIES**

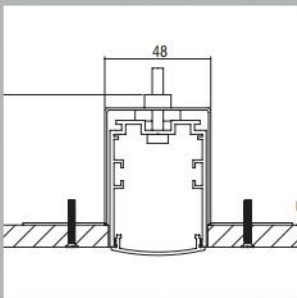
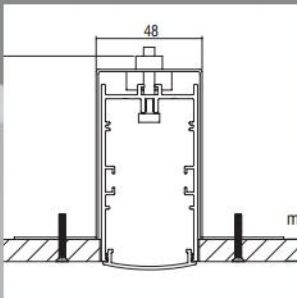

CE			

- Metal suspension bracket.
- Required 1pc per 1m profile length.

Code	Description	Kg
900250	Suspension Bracket High System Surface-Trimless	0,470
900260	Suspension Bracket Low System Surface-Trimless	0,470

## SLOTLIGHT TRIMLESS

*The trimless version of SLOTLIGHT, with the diffuser position deeper from the ceiling level, gives the impression of an almost immaterial luminaire fully integrated to the ceiling. This architectural advantage, in combination with the perfect lighting conditions without annoying reflections, make the Trimless Slotlight suitable for many different working areas (offices, houses, entrance areas etc). Uniformly illuminated lines with no dark shadows can be created thanks to the "tetris" installation of the T16 fluorescent lamps. The LED version escapes the restrictions of the T16 fluorescent lamps, by using LED lighting points that can have any spacing pitch, and this gives the light line enormous flexibility. The visual benefit: The continuous-row system is illuminated absolutely uniformly from beginning to end, is economically efficient, maintenance free and it has long service-life.*

### Technical Features

- Housing from aluminium profile, painted electrostatically in selected colour.
- High efficient diffuser in opal PMMA.
- Flow recuperator in white colour.

#### Upon request

- Connection for operation with electronic dimmable ballast.

#### For LED Version

- Pure light without IR/UV radiation.
- Efficient thermal management.
- Up to 28W/m and 3864 Lm luminous flux range.
- Operation life: 50,000 hours with efficiency > 70% of the initial luminous flux.
- Connection for operation on 230V/50Hz.

#### Upon request:

Available with highest colour rendering index (CRI)



SLOTLIGHT TRIMLESS

SLOTLIGHT TRIMLESS



- Version for T16.
- Aluminium body.
- High efficient diffuser in opal PMMA.
- Flow recuperator in white colour.
- Suspension brackets not included.

Code	Description	L	Kg
92501	Slotlight Trimless 1x13/14W T16	610	1,300
92503	Slotlight Trimless 1x20/24W T16	610	1,300
92505	Slotlight Trimless 1x19/21W T16	910	1,940
92507	Slotlight Trimless 1x34/39W T16	910	1,940
92509	Slotlight Trimless 1x25/28W T16	1210	2,580
92511	Slotlight Trimless 1x50/54W T16	1210	2,580
92513	Slotlight Trimless 1x32/35W T16	1510	3,220
92515	Slotlight Trimless 1x45/49W T16	1510	3,220
92517	Slotlight Trimless 1x73/80W T16	1510	3,220
92537	Slotlight Trimless 2x13/14W T16	610	1,300
92539	Slotlight Trimless 2x20/24W T16	610	1,300
92541	Slotlight Trimless 2x19/21W T16	910	1,940
92543	Slotlight Trimless 2x34/39W T16	910	1,940
92545	Slotlight Trimless 2x25/28W T16	1210	2,580
92547	Slotlight Trimless 2x50/54W T16	1210	2,580
92549	Slotlight Trimless 2x32/35W T16	1510	3,220
92551	Slotlight Trimless 2x45/49W T16	1510	3,220
92553	Slotlight Trimless 2x73/80W T16	1510	3,220
92523	Slotlight Trimless 1+1x19/21W T16	1675	3,570
92525	Slotlight Trimless 1+1x34/39W T16	1675	3,570
92527	Slotlight Trimless 1+1x25/28W T16	2275	4,850
92529	Slotlight Trimless 1+1x50/54W T16	2275	4,850
92531	Slotlight Trimless 1+1x32/35W T16	2875	6,130
92533	Slotlight Trimless 1+1x45/49W T16	2875	6,130
92535	Slotlight Trimless 1+1x73/80W T16	2875	6,130
92559	Slotlight Trimless 2+2x19/21W T16	1885	4,020
92561	Slotlight Trimless 2+2x34/39W T16	1885	4,020
92563	Slotlight Trimless 2+2x25/28W T16	2485	5,300
92565	Slotlight Trimless 2+2x50/54W T16	2485	5,300
92567	Slotlight Trimless 2+2x32/35W T16	3085	6,580
92569	Slotlight Trimless 2+2x45/49W T16	3085	6,580
92571	Slotlight Trimless 2+2x73/80W T16	3085	6,580

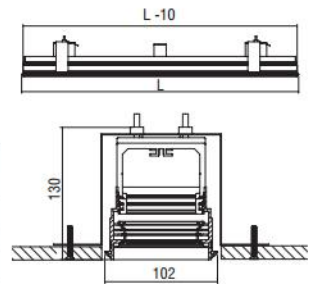

Hole

1-2x13/14W - 20/24W T16	108 x 616
1-2x19/21W - 34/39W T16	108 x 916
1-2x25/28W - 50/54W T16	108 x 1216
1-2x32/35W - 45/49W T16	108 x 1516
1-2x73/80W T16	108 x 1516
1+1x19/21W - 34/39W T16	108 x 1681
1+1x25/28W - 50/54W T16	108 x 2281
1+1x32/35W - 45/49W T16	108 x 2881
1+1x73/80W T16	108 x 2881
2+2x19/21W - 34/39W T16	108 x 1891
2+2x25/28W - 50/54W T16	108 x 2491
2+2x32/35W - 45/49W T16	108 x 3091
2+2x73/80W T16	108 x 3091



SLOTLIGHT TRIMLESS LED



- Version for LED CHIP.
- Aluminium body.
- High efficient diffuser in opal PMMA.
- Flow recuperator in white colour.
- Suspension brackets not included.
- Efficiency: max.138 Lumen / Watt.

Code	Description	L	Kg
92573	Slotlight Trimless Led 16W 2200 lm Neutral	620	1,320
92574	Slotlight Trimless Led 28W 3100 lm Neutral	1180	2,520
92575	Slotlight Trimless Led 33W 4400 lm Neutral	1180	2,520
92576	Slotlight Trimless Led 42W 4650 lm Neutral	1740	3,700
92577	Slotlight Trimless Led 49W 6600 lm Neutral	1740	3,700
92578	Slotlight Trimless Led 56W 6200 lm Neutral	2300	4,900
92579	Slotlight Trimless Led 65W 8800 lm Neutral	2300	4,900
92580	Slotlight Trimless Led 16W 2200 lm Warm	620	1,320
92582	Slotlight Trimless Led 33W 4400 lm Warm	1180	2,520
92584	Slotlight Trimless Led 49W 6600 lm Warm	1740	3,700
92586	Slotlight Trimless Led 65W 8800 lm Warm	2300	4,900

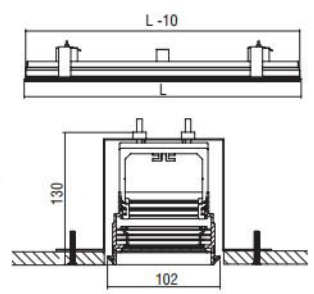

Hole

16W	108 x 626
28W - 33W	108 x 1186
42W - 49W	108 x 1746
56W - 65W	108 x 2306

Colour Codes:

0 Colours	1 White	2 Titan	3 Black
-----------	---------	---------	---------

SLOTLIGHT TRIMLESS

SLOTLIGHT TRIMLESS ANAGLYPH



- Version for T16.
- Aluminium body.
- Diffuser in opal of 10mm PMMA.
- Flow recuperator in white colour.
- Suspension brackets not included.

Code	Description	L	Kg
92601	Slotlight Trimless Anaglyph 1x13/14W T16	610	2,100
92603	Slotlight Trimless Anaglyph 1x20/24W T16	610	2,100
92605	Slotlight Trimless Anaglyph 1x19/21W T16	910	3,130
92607	Slotlight Trimless Anaglyph 1x34/39W T16	910	3,130
92609	Slotlight Trimless Anaglyph 1x25/28W T16	1210	4,170
92611	Slotlight Trimless Anaglyph 1x50/54W T16	1210	4,170
92613	Slotlight Trimless Anaglyph 1x32/35W T16	1510	5,200
92615	Slotlight Trimless Anaglyph 1x45/49W T16	1510	5,200
92617	Slotlight Trimless Anaglyph 1x73/80W T16	1510	5,200
92637	Slotlight Trimless Anaglyph 2x13/14W T16	610	2,100
92639	Slotlight Trimless Anaglyph 2x20/24W T16	610	2,100
92641	Slotlight Trimless Anaglyph 2x19/21W T16	910	3,130
92643	Slotlight Trimless Anaglyph 2x34/39W T16	910	3,130
92645	Slotlight Trimless Anaglyph 2x25/28W T16	1210	4,170
92647	Slotlight Trimless Anaglyph 2x50/54W T16	1210	4,170
92649	Slotlight Trimless Anaglyph 2x32/35W T16	1510	5,200
92651	Slotlight Trimless Anaglyph 2x45/49W T16	1510	5,200
92653	Slotlight Trimless Anaglyph 2x73/80W T16	1510	5,200
92623	Slotlight Trimless Anaglyph 1 + 1x19/21W T16	1675	5,770
92625	Slotlight Trimless Anaglyph 1 + 1x34/39W T16	1675	5,770
92627	Slotlight Trimless Anaglyph 1 + 1x25/28W T16	2275	7,830
92629	Slotlight Trimless Anaglyph 1 + 1x50/54W T16	2275	7,830
92631	Slotlight Trimless Anaglyph 1 + 1x32/35W T16	2875	9,890
92633	Slotlight Trimless Anaglyph 1 + 1x45/49W T16	2875	9,890
92635	Slotlight Trimless Anaglyph 1 + 1x73/80W T16	2875	9,890
92659	Slotlight Trimless Anaglyph 2 + 2x19/21W T16	1885	6,490
92661	Slotlight Trimless Anaglyph 2 + 2x34/39W T16	1885	6,490
92663	Slotlight Trimless Anaglyph 2 + 2x25/28W T16	2485	8,550
92665	Slotlight Trimless Anaglyph 2 + 2x50/54W T16	2485	8,550
92667	Slotlight Trimless Anaglyph 2 + 2x32/35W T16	3085	10,620
92669	Slotlight Trimless Anaglyph 2 + 2x45/49W T16	3085	10,620
92671	Slotlight Trimless Anaglyph 2 + 2x73/80W T16	3085	10,620

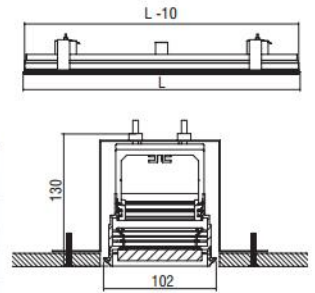

**Hole**

1-2x13/14W - 20/24W T16	108 x 616
1-2x19/21W - 34/39W T16	108 x 916
1-2x25/28W - 50/54W T16	108 x 1216
1-2x32/35W - 45/49W T16	108 x 1516
1-2x73/80W T16	108 x 1516
1+1x19/21W - 34/39W T16	108 x 1681
1+1x25/28W - 50/54W T16	108 x 2281
1+1x32/35W - 45/49W T16	108 x 2881
1+1x73/80W T16	108 x 2881
2+2x19/21W - 34/39W T16	108 x 1891
2+2x25/28W - 50/54W T16	108 x 2491
2+2x32/35W - 45/49W T16	108 x 3091
2+2x73/80W T16	108 x 3091

CE F IP 43

T16

CONFORME TO PHILIPS T16

Included

SLOTLIGHT TRIMLESS ANAGLYPH LED



CE F IP 20 43

LED

3 YEAR WARRANTY

ta 25°C

Included

- Version for LED CHIP.
- Aluminium body.
- Diffuser in opal of 10mm PMMA.
- Flow recuperator in white colour.
- Suspension brackets not included.
- Efficiency: max.138 Lumen / Watt.

Code	Description	L	Kg
92673	Slotlight Trimless Anaglyph Led 16W 2200 lm Neutral	620	2,140
92674	Slotlight Trimless Anaglyph Led 28W 3100 lm Neutral	1180	4,060
92675	Slotlight Trimless Anaglyph Led 33W 4400 lm Neutral	1180	4,060
92676	Slotlight Trimless Anaglyph Led 42W 4650 lm Neutral	1740	5,990
92677	Slotlight Trimless Anaglyph Led 49W 6600 lm Neutral	1740	5,990
92678	Slotlight Trimless Anaglyph Led 56W 6200 lm Neutral	2300	7,920
92679	Slotlight Trimless Anaglyph Led 65W 8800 lm Neutral	2300	7,920
92680	Slotlight Trimless Anaglyph Led 16W 2200 lm Warm	620	2,140
92682	Slotlight Trimless Anaglyph Led 33W 4400 lm Warm	1180	4,060
92684	Slotlight Trimless Anaglyph Led 49W 6600 lm Warm	1740	5,990
92686	Slotlight Trimless Anaglyph Led 65W 8800 lm Warm	2300	7,920

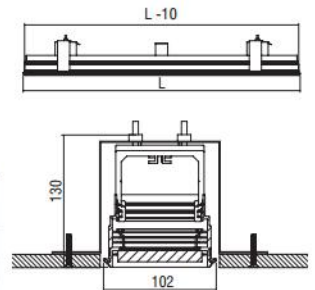

**Hole**

16W	108 x 626
28W - 33W	108 x 1186
42W - 49W	108 x 1746
56W - 65W	108 x 2306

Colour Codes:

- 0 Colours 1 White 2 Titan 3 Black

SLOTLIGHT TRIMLESS

SLOTLIGHT TRIMLESS LOUVRE



- Version for T16.
- Aluminium body.
- Parabolic reflector in specular anodized aluminium.
- Suspension brackets not included.

Code	Description	L	Kg
94303	Slotlight Trimless Louvre 1x20/24W T16	610	1,300
94307	Slotlight Trimless Louvre 1x34/39W T16	910	1,940
94311	Slotlight Trimless Louvre 1x50/54W T16	1210	2,580
94315	Slotlight Trimless Louvre 1x45/49W T16	1510	3,220
94317	Slotlight Trimless Louvre 1x73/80W T16	1510	3,220
94325	Slotlight Trimless Louvre 1+1x34/39W T16	1786	3,800
94329	Slotlight Trimless Louvre 1+1x50/54W T16	2386	5,090
94333	Slotlight Trimless Louvre 1+1x45/49W T16	2986	6,360
94335	Slotlight Trimless Louvre 1+1x73/80W T16	2986	6,360

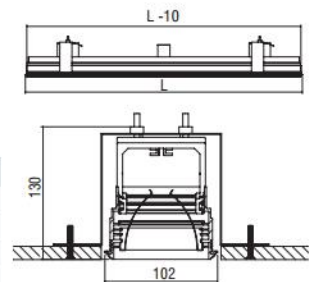

Hole	
1x20/24W T16	95 x 604
1x34/39W T16	95 x 904
1x50/54W T16	95 x 1204
1x45/49W - 73/80W T16	95 x 1504
1+1x34/39W T16	95 x 1780
1+1x50/54W T16	95 x 2380
1+1x45/49W - 73/80W T16	95 x 2980

CE	F	IP 20
ELV		
T16		
OSRAM: T6 PHILIPS: T13		
	Included	

**Colour Codes:**

0	Colours	1	White	2	Titan	3	Black
---	---------	---	-------	---	-------	---	-------

SLOTLIGHT TRIMLESS

SLOTLIGHT TRIMLESS + Module 50 G5.3



CE	F	850°C	IP 20
25°	350°		
OSRAM SYMBIOSE BY PHILIPS INTELLIGENT			
		12V	

- Simple version for incandescent halogen max.50W 12V (QR-CBC 51).

Code	Description	L	Kg
95204	Slotlight Trimless Module 50 1x max.50W/G5,3	300	1,570
95205	Slotlight Trimless Module 50 2x max.50W/G5,3	450	2,360

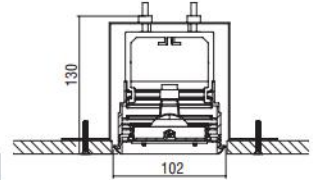

SLOTLIGHT TRIMLESS + Module 50 GU10



CE	F	850°C	IP 20
30°	350°		
PAR 16	LED	FLUO	

- Simple version for incandescent halogen max.50W 230V (PAR16).

Code	Description	L	Kg
95201	Slotlight Trimless Module 50 1x max.50W/GU10	170	0,890
95202	Slotlight Trimless Module 50 2x max.50W/GU10	250	1,300

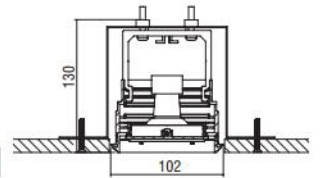

SLOTLIGHT TRIMLESS + Module 50 IRA 2 Reflector



CE	F	850°C	IP 20
25°	350°		
LED		ta 25°C	350mA

- Reflectors: Medium, Wide.  
 - 7W power consumption driven at 350mA.  
 - Efficiency:  
 4000 K: 770 Lumen, CRI: min. 80  
 3000 K: 730 Lumen, CRI: min. 80  
 Maximum: 110 Lm/W

Code	Description	L	Kg
95207	Slotlight Trimless Module 50 1x IRA 2 7W Reflector	300	1,570
95208	Slotlight Trimless Module 50 2x IRA 2 7W Reflector	450	2,360

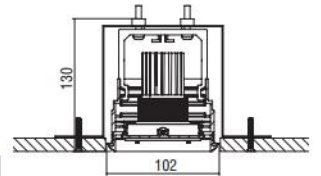

SLOTLIGHT TRIMLESS + Module 50 DIMITRA 2 Reflector HO



CE	F	850°C	IP 40
25°	350°		
LED		ta 25°C	500mA

- Reflectors: Spot, Medium, Wide.  
 - 5W power consumption driven at 500mA.  
 - Efficiency:  
 5W: 4000 K: 510 Lumen, CRI: min. 80  
 5W: 3000 K: 485 Lumen, CRI: min. 80  
 Maximum: 102 Lm/W

Code	Description	L	Kg
95209	Slotlight Trimless Module 50 1x DIMITRA 2 5W Ref.HO	300	1,570
95210	Slotlight Trimless Module 50 2x DIMITRA 2 5W Ref.HO	450	2,360

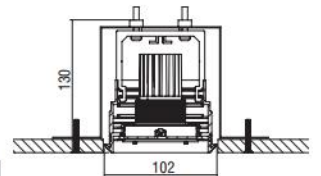

SLOTLIGHT TRIMLESS + Module 50 ARTEMIS 2 Diffuser Prismatic



CE	F	850°C	IP 40
25°	350°		
LED		ta 25°C	350/500mA

- Beam: Diffuser.  
 - 5W power consumption driven at 500mA.  
 - 7W power consumption driven at 350mA.  
 - Efficiency:  
 5W: 4000 K: 510 Lumen, CRI: min. 80  
 5W: 3000 K: 485 Lumen, CRI: min. 80  
 7W: 4000 K: 770 Lumen, CRI: min. 80  
 7W: 3000 K: 730 Lumen, CRI: min. 80  
 Maximum: 110 Lm/W

Code	Description	L	Kg
95211	Slotlight Trimless Module 50 1x ARTEMIS 2 5W Diffuser Prism.	300	1,570
95212	Slotlight Trimless Module 50 2x ARTEMIS 2 5W Diffuser Prism.	450	2,360
95213	Slotlight Trimless Module 50 1x ARTEMIS 2 7W Diffuser Prism.	300	1,570
95214	Slotlight Trimless Module 50 2x ARTEMIS 2 7W Diffuser Prism.	450	2,360

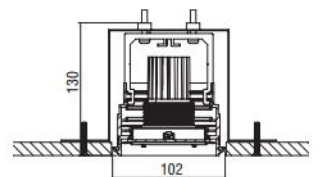



SLOTLIGHT TRIMLESS

SLOTLIGHT TRIMLESS + Module 50 ATHINA 2 Diffuser Opal



CE	F	850°C	IP 40
20°	350°		
D			
LED	5 YEAR WARRANTY	ta 25°C	350/500mA

- Beam: Diffuser.
- 5W power consumption driven at 500mA.
- 7W power consumption driven at 350mA.
- Efficiency:
- 5W: 4000 K: 510 Lumen, CRI: min. 80
- 5W: 3000 K: 485 Lumen, CRI: min. 80
- 7W: 4000 K: 770 Lumen, CRI: min. 80
- 7W: 3000 K: 730 Lumen, CRI: min. 80
- Maximum: 110 Lm/W

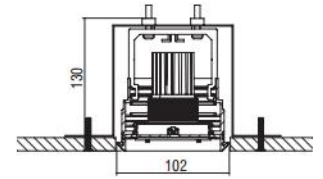

Code	Description	L	Kg
95215	Slotlight Trimless Module 50 1x ATHINA 2 5W Diffuser Opal	300	1,570
95216	Slotlight Trimless Module 50 2x ATHINA 2 5W Diffuser Opal	450	2,360
95217	Slotlight Trimless Module 50 1x ATHINA 2 7W Diffuser Opal	300	1,570
95218	Slotlight Trimless Module 50 2x ATHINA 2 7W Diffuser Opal	450	2,360

SLOTLIGHT TRIMLESS + Module 50 VENUS 2 Lens



CE	F	850°C	IP 40
25°	350°		
LED	5 YEAR WARRANTY	ta 25°C	350/700mA

- Lens: Spot, Medium, Wide.
- 3W power consumption driven at 350mA.
- 6W power consumption driven at 700mA.
- Efficiency:
- 3W: 4000 K: 321 Lumen, CRI: min. 75
- 3W: 3000 K: 300 Lumen, CRI: min. 80
- 6W: 4000 K: 600 Lumen, CRI: min. 75
- 6W: 3000 K: 570 Lumen, CRI: min. 80
- Maximum: 107 Lm/W

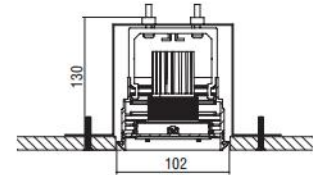

Code	Description	L	Kg
95219	Slotlight Trimless Module 50 1x VENUS 2 3W/6W Lens	300	1,570
95220	Slotlight Trimless Module 50 2x VENUS 2 3W/6W Lens	450	2,360

SLOTLIGHT TRIMLESS + Module 30



CE	F		IP 20
0°	360°		
LED	5 YEAR WARRANTY	ta 25°C	Included

- Version for LED CHIP.
- Aluminium body.
- Lens in Spot, Medium, Wide or spot reflector selection.

Code	Description	L	Kg
95221	Slotlight Trimless Module 30 1x2W Lens	240	1,260
95222	Slotlight Trimless Module 30 2x2W Lens	320	1,680
95223	Slotlight Trimless Module 30 3x2W Lens	400	2,100
95224	Slotlight Trimless Module 30 1x2W Reflector	240	1,260
95225	Slotlight Trimless Module 30 2x2W Reflector	320	1,680
95226	Slotlight Trimless Module 30 3x2W Reflector	400	2,100

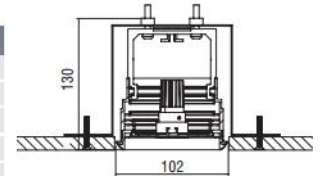

LED COLOUR CODES:

2 Warm 3 Neutral

BEAM CODES:

01 spot 02 medium 03 wide

Colour Codes:

0 Colours 1 White 2 Titan 3 Black

SLOTLIGHT TRIMLESS ACCESSORIES

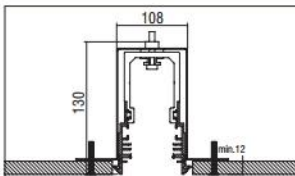

CE			
----	--	--	--

- Metal suspension bracket.
- Required 1pc per 1m profile length.

Code	Description	Kg
900510	Suspension Bracket Slotlight Trimless	0,270

**STREAMLIGHT TRIMLESS**

*The trimless version of STREAMLIGHT, with the diffuser position deeper from the ceiling level, gives the impression of an almost immaterial luminaire fully integrated to the ceiling.*

*This architectural advantage, in combination with the perfect lighting conditions without annoying reflections, make the Trimless Streamlight suitable for many different working areas (offices, houses, entrance areas etc).*

*Uniformly illuminated lines with no dark shadows can be created thanks to the "tetris" installation of the T16 fluorescent lamps.*

*The LED version escapes the restrictions of the T16 fluorescent lamps, by using LED lighting points that can have any spacing pitch, and this gives the light line enormous flexibility. The visual benefit: The continuous-row system is illuminated absolutely uniformly from beginning to end, is economically efficient, maintenance free and it has long service-life.*

**Technical Features**

- Housing from aluminium profile, painted electrostatically in selected colour.
- High efficient diffuser in opal PMMA.
- Flow recuperator in white colour.

**Upon request**

- Connection for operation with electronic dimmable ballast.

**For LED Version**

- Pure light without IR/UV radiation.
- Efficient thermal management.
- Up to 28W/m and 3864 Lm luminous flux range.
- Operation life: 50,000 hours with efficiency > 70% of the initial luminous flux.
- Connection for operation on 230V/50Hz.

**Upon request:**

Available with highest colour rendering index (CRI)

STREAMLIGHT TRIMLESS

STREAMLIGHT TRIMLESS TETRIS



- Version for T16.
- Aluminium body.
- High efficient diffuser in opal PMMA.
- Flow recuperator in white colour.
- Suspension brackets not included.

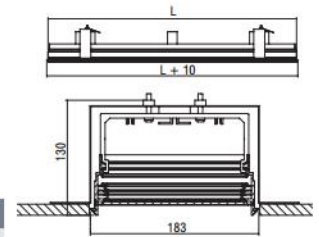

Code	Description	L	Kg
94437	Streamlight Trimless Tetris 2x13/14W T16	610	2,140
94439	Streamlight Trimless Tetris 2x20/24W T16	610	2,140
94441	Streamlight Trimless Tetris 2x19/21W T16	910	3,190
94443	Streamlight Trimless Tetris 2x34/39W T16	910	3,190
94445	Streamlight Trimless Tetris 2x25/28W T16	1210	4,240
94447	Streamlight Trimless Tetris 2x50/54W T16	1210	4,240
94449	Streamlight Trimless Tetris 2x32/35W T16	1510	5,290
94451	Streamlight Trimless Tetris 2x45/49W T16	1510	5,290
94453	Streamlight Trimless Tetris 2x73/80W T16	1510	5,290
94463	Streamlight Trimless Tetris 2+2x25/28W T16	2275	7,970
94465	Streamlight Trimless Tetris 2+2x50/54W T16	2275	7,970
94467	Streamlight Trimless Tetris 2+2x32/35W T16	2875	10,070
94469	Streamlight Trimless Tetris 2+2x45/49W T16	2875	10,070
94471	Streamlight Trimless Tetris 2+2x73/80W T16	2875	10,070

Hole	
2x13/14W - 20/24W T16	189 x 616
2x19/21W - 34/39W T16	189 x 916
2x25/28W - 50/54W T16	189 x 1216
2x32/35W - 45/49W T16	189 x 1516
2x73/80W T16	189 x 1516
2+2x25/28W - 50/54W T16	189 x 2281
2+2x32/35W - 45/49W T16	189 x 2881
2+2x73/80W T16	189 x 2881

CE IP 20  
43

T16

OSRAM: T5  
PHILIPS: T1.5

Included

STREAMLIGHT TRIMLESS LED



- Version for LED CHIP.
- Aluminium body.
- High efficient diffuser in opal PMMA.
- Flow recuperator in white colour.
- Suspension brackets not included.
- Efficiency: max. 138 Lumen / Watt.

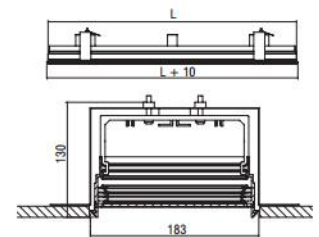

Code	Description	L	Kg
94473	Streamlight Trimless Led 16W 2200 lm Neutral	620	2,170
94474	Streamlight Trimless Led 33W 4400 lm Neutral	1180	4,130
94475	Streamlight Trimless Led 49W 6600 lm Neutral	1740	6,090
94476	Streamlight Trimless Led 65W 8800 lm Neutral	2300	8,050
94477	Streamlight Trimless Led 16W 2200 lm Warm	620	2,170
94478	Streamlight Trimless Led 33W 4400 lm Warm	1180	4,130
94479	Streamlight Trimless Led 49W 6600 lm Warm	1740	6,090
94480	Streamlight Trimless Led 65W 8800 lm Warm	2300	8,050

Hole	
16W	189 x 626
33W	189 x 1186
49W	189 x 1746
65W	189 x 2306

CE IP 20  
43

LED ta 25°C

Colour Codes:

0	Colours	1	White	2	Titan	3	Black
---	---------	---	-------	---	-------	---	-------

STREAMLIGHT TRIMLESS

STREAMLIGHT TRIMLESS ANAGLYPH



- Version for T16.
- Aluminium body.
- Diffuser in opal of 10mm PMMA.
- Flow recuperator in white colour.
- Suspension brackets not included.

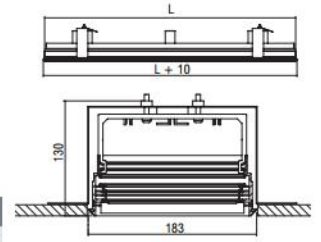

Code	Description	L	Kg
94537	Streamlight Trimless Anaglyph 2x13/14W T16	610	3,090
94539	Streamlight Trimless Anaglyph 2x20/24W T16	610	3,090
94541	Streamlight Trimless Anaglyph 2x19/21W T16	910	4,610
94543	Streamlight Trimless Anaglyph 2x34/39W T16	910	4,610
94545	Streamlight Trimless Anaglyph 2x25/28W T16	1210	6,130
94547	Streamlight Trimless Anaglyph 2x50/54W T16	1210	6,130
94549	Streamlight Trimless Anaglyph 2x32/35W T16	1510	7,640
94551	Streamlight Trimless Anaglyph 2x45/49W T16	1510	7,640
94553	Streamlight Trimless Anaglyph 2x73/80W T16	1510	7,640
94563	Streamlight Trimless Anaglyph 2+ 2x25/28W T16	2275	11,520
94565	Streamlight Trimless Anaglyph 2+ 2x50/54W T16	2275	11,520
94567	Streamlight Trimless Anaglyph 2+ 2x32/35W T16	2875	14,550
94569	Streamlight Trimless Anaglyph 2+ 2x45/49W T16	2875	14,550
94571	Streamlight Trimless Anaglyph 2+ 2x73/80W T16	2875	14,550

Hole		
2x13/14W - 20/24W T16	189 x	616
2x19/21W - 34/39W T16	189 x	916
2x25/28W - 50/54W T16	189 x	1216
2x32/35W - 45/49W T16	189 x	1516
2x73/80W T16	189 x	1516
2+2x25/28W - 50/54W T16	189 x	2281
2+2x32/35W - 45/49W T16	189 x	2881
2+2x73/80W T16	189 x	2881

CE F IP 20 43

T16

OSRAM: 15 PHILIPS: 15.5

Included

STREAMLIGHT TRIMLESS ANAGLYPH LED



- Version for LED CHIP.
- Aluminium body.
- Diffuser in opal of 10mm PMMA.
- Flow recuperator in white colour.
- Suspension brackets not included.
- Efficiency: max.138 Lumen / Watt.

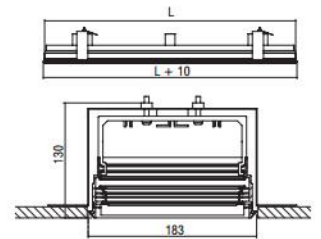

Code	Description	L	Kg
94573	Streamlight Trimless Anaglyph Led 16W 2200 lm Neutral	620	3,140
94574	Streamlight Trimless Anaglyph Led 33W 4400 lm Neutral	1180	5,970
94575	Streamlight Trimless Anaglyph Led 49W 6600 lm Neutral	1740	8,810
94576	Streamlight Trimless Anaglyph Led 65W 8800 lm Neutral	2300	11,640
94577	Streamlight Trimless Anaglyph Led 16W 2200 lm Warm	620	3,140
94578	Streamlight Trimless Anaglyph Led 33W 4400 lm Warm	1180	5,970
94579	Streamlight Trimless Anaglyph Led 49W 6600 lm Warm	1740	8,810
94580	Streamlight Trimless Anaglyph Led 65W 8800 lm Warm	2300	11,640

Hole		
16W	189 x	626
33W	189 x	1186
49W	189 x	1746
65W	189 x	2306

CE F IP 20 43

LED

ta 25°C

Included

Colour Codes:

0	Colours	1	White	2	Titan	3	Black
---	---------	---	-------	---	-------	---	-------

STREAMLIGHT TRIMLESS

STREAMLIGHT TRIMLESS PLEXI OPAL CARRE

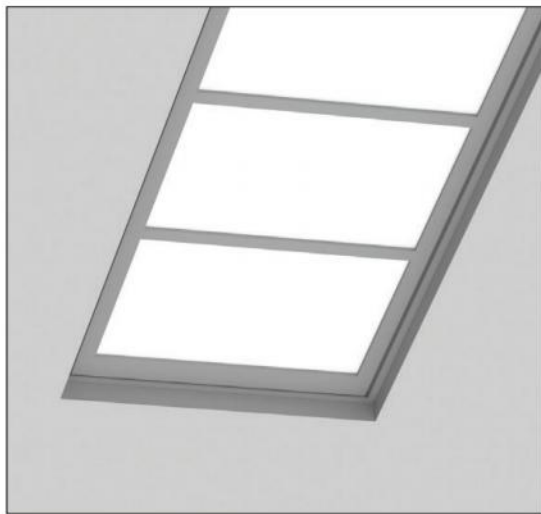

- Version for T16.
- Aluminium body.
- High efficient diffuser in opal PMMA.
- Flow recuperator in white colour.
- Suspension brackets not included.

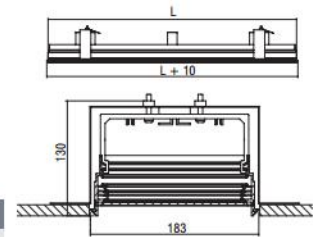

Code	Description	L	Kg
94737	Streamlight Trimless Plexi Opal Carré 2x13/14W T16	610	3,140
94739	Streamlight Trimless Plexi Opal Carré 2x20/24W T16	610	3,140
94741	Streamlight Trimless Plexi Opal Carré 2x19/21W T16	910	4,680
94743	Streamlight Trimless Plexi Opal Carré 2x34/39W T16	910	4,680
94745	Streamlight Trimless Plexi Opal Carré 2x25/28W T16	1210	6,220
94747	Streamlight Trimless Plexi Opal Carré 2x50/54W T16	1210	6,220
94749	Streamlight Trimless Plexi Opal Carré 2x32/35W T16	1510	7,800
94751	Streamlight Trimless Plexi Opal Carré 2x45/49W T16	1510	7,800
94753	Streamlight Trimless Plexi Opal Carré 2x73/80W T16	1510	7,800
94763	Streamlight Trimless Plexi Opal Carré 2+2x25/28W T16	2275	11,740
94765	Streamlight Trimless Plexi Opal Carré 2+2x50/54W T16	2275	11,740
94767	Streamlight Trimless Plexi Opal Carré 2+2x32/35W T16	2875	14,840
94769	Streamlight Trimless Plexi Opal Carré 2+2x45/49W T16	2875	14,840
94771	Streamlight Trimless Plexi Opal Carré 2+2x73/80W T16	2875	14,840

Hole		
2x13/14W - 20/24W T16	189 x	616
2x19/21W - 34/39W T16	189 x	916
2x25/28W - 50/54W T16	189 x	1216
2x32/35W - 45/49W T16	189 x	1516
2x73/80W T16	189 x	1516
2+2x25/28W - 50/54W T16	189 x	2281
2+2x32/35W - 45/49W T16	189 x	2881
2+2x73/80W T16	189 x	2881

CE IP 20  
43

T16

ORDER TO FOLLOW T16

Included

STREAMLIGHT TRIMLESS PLEXI OPAL CARRE LED

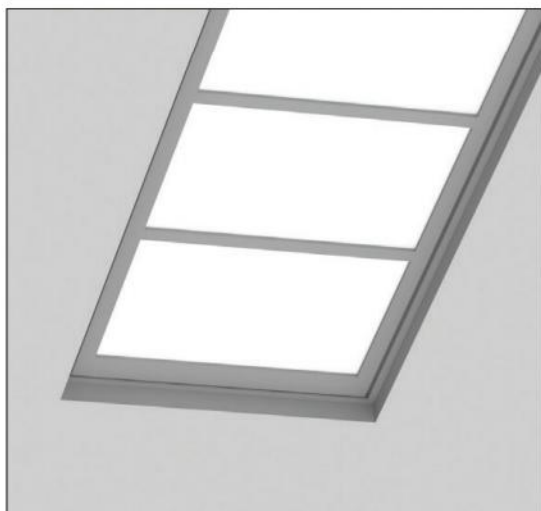

- Version for LED CHIP.
- Aluminium body.
- High efficient diffuser in opal PMMA.
- Flow recuperator in white colour.
- Suspension brackets not included.
- Efficiency: max.138 Lumen / Watt.

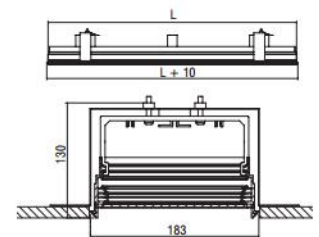

Code	Description	L	Kg
94773	Streamlight Trimless Plexi Opal Carré Led 16W 2200 lm Neutral	620	3,200
94774	Streamlight Trimless Plexi Opal Carré Led 33W 4400 lm Neutral	1180	6,090
94775	Streamlight Trimless Plexi Opal Carré Led 49W 6600 lm Neutral	1740	8,980
94776	Streamlight Trimless Plexi Opal Carré Led 65W 8800 lm Neutral	2300	11,870
94777	Streamlight Trimless Plexi Opal Carré Led 16W 2200 lm Warm	620	3,200
94778	Streamlight Trimless Plexi Opal Carré Led 33W 4400 lm Warm	1180	6,090
94779	Streamlight Trimless Plexi Opal Carré Led 49W 6600 lm Warm	1740	8,980
94780	Streamlight Trimless Plexi Opal Carré Led 65W 8800 lm Warm	2300	11,870

Hole		
16W	189 x	626
33W	189 x	1186
49W	189 x	1746
65W	189 x	2306

CE IP 20  
43

LED ta 25°C

Included

Colour Codes:

0	Colours	1	White	2	Titan	3	Black
---	---------	---	-------	---	-------	---	-------

STREAMLIGHT TRIMLESS

STREAMLIGHT TRIMLESS PLEXI OPAL DOUBLE

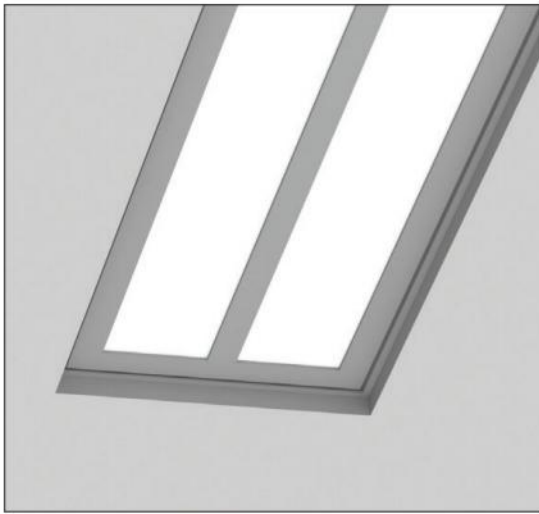

- Version for T16.
- Aluminium body.
- High efficient diffuser in opal PMMA.
- Flow recuperator in white colour.
- Suspension brackets not included.

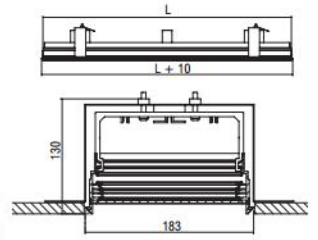

Code	Description	L	Kg
94837	Streamlight Trimless Plexi Opal Double 2x13/14W T16	610	2,140
94839	Streamlight Trimless Plexi Opal Double 2x20/24W T16	610	2,140
94841	Streamlight Trimless Plexi Opal Double 2x19/21W T16	910	3,190
94843	Streamlight Trimless Plexi Opal Double 2x34/39W T16	910	3,190
94845	Streamlight Trimless Plexi Opal Double 2x25/28W T16	1210	4,240
94847	Streamlight Trimless Plexi Opal Double 2x50/54W T16	1210	4,240
94849	Streamlight Trimless Plexi Opal Double 2x32/35W T16	1510	5,290
94851	Streamlight Trimless Plexi Opal Double 2x45/49W T16	1510	5,290
94853	Streamlight Trimless Plexi Opal Double 2x73/80W T16	1510	5,290
94863	Streamlight Trimless Plexi Opal Double 2+2x25/28W T16	2275	7,970
94865	Streamlight Trimless Plexi Opal Double 2+2x50/54W T16	2275	7,970
94867	Streamlight Trimless Plexi Opal Double 2+2x32/35W T16	2875	10,070
94869	Streamlight Trimless Plexi Opal Double 2+2x45/49W T16	2875	10,070
94871	Streamlight Trimless Plexi Opal Double 2+2x73/80W T16	2875	10,070

Hole		
2x13/14W - 20/24W T16	189 x	616
2x19/21W - 34/39W T16	189 x	916
2x25/28W - 50/54W T16	189 x	1216
2x32/35W - 45/49W T16	189 x	1516
2x73/80W T16	189 x	1516
2+2x25/28W - 50/54W T16	189 x	2281
2+2x32/35W - 45/49W T16	189 x	2881
2+2x73/80W T16	189 x	2881

CE F IP 20 43

T16

OSRAM T5 PHILIPS T5

Included

STREAMLIGHT TRIMLESS PLEXI OPAL DOUBLE LED

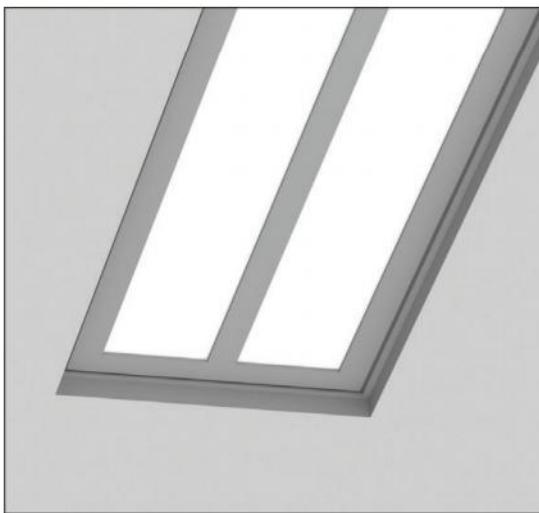

- Version for LED CHIP.
- Aluminium body.
- High efficient diffuser in opal PMMA.
- Flow recuperator in white colour.
- Suspension brackets not included.
- Efficiency: max.138 Lumen / Watt.

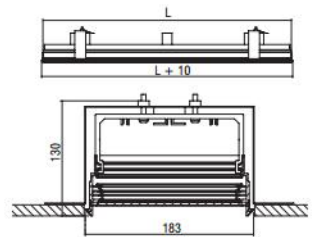

Code	Description	L	Kg
94873	Streamlight Trimless Plexi Opal Double Led 16W 2200 lm Neutral	620	2,170
94874	Streamlight Trimless Plexi Opal Double Led 33W 4400 lm Neutral	1180	4,130
94875	Streamlight Trimless Plexi Opal Double Led 49W 6600 lm Neutral	1740	6,090
94876	Streamlight Trimless Plexi Opal Double Led 65W 8800 lm Neutral	2300	8,050
94877	Streamlight Trimless Plexi Opal Double Led 16W 2200 lm Warm	620	2,170
94878	Streamlight Trimless Plexi Opal Double Led 33W 4400 lm Warm	1180	4,130
94879	Streamlight Trimless Plexi Opal Double Led 49W 6600 lm Warm	1740	6,090
94880	Streamlight Trimless Plexi Opal Double Led 65W 8800 lm Warm	2300	8,050

Hole		
16W	189 x	626
33W	189 x	1186
49W	189 x	1746
65W	189 x	2306

CE F IP 20 43

LED

ta 25°C

Included

Colour Codes:

0	Colours	1	White	2	Titan	3	Black
---	---------	---	-------	---	-------	---	-------

STREAMLIGHT TRIMLESS

STREAMLIGHT TRIMLESS LOUVRE



- Version for T16.
- Aluminium body.
- Parabolic reflector in specular anodized aluminium.
- Suspension brackets not included.

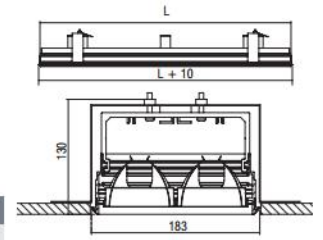

Code	Description	L	Kg
94637	Streamlight Trimless Louvre 2x13/14W T16	610	2,100
94639	Streamlight Trimless Louvre 2x20/24W T16	610	2,100
94641	Streamlight Trimless Louvre 2x19/21W T16	910	3,140
94643	Streamlight Trimless Louvre 2x34/39W T16	910	3,140
94645	Streamlight Trimless Louvre 2x25/28W T16	1210	4,170
94647	Streamlight Trimless Louvre 2x50/54W T16	1210	4,170
94649	Streamlight Trimless Louvre 2x32/35W T16	1510	5,200
94651	Streamlight Trimless Louvre 2x45/49W T16	1510	5,200
94653	Streamlight Trimless Louvre 2x73/80W T16	1510	5,200
94663	Streamlight Trimless Louvre 2+2x25/28W T16	2386	7,830
94665	Streamlight Trimless Louvre 2+2x50/54W T16	2386	7,830
94667	Streamlight Trimless Louvre 2+2x32/35W T16	2986	9,890
94669	Streamlight Trimless Louvre 2+2x45/49W T16	2986	9,890
94671	Streamlight Trimless Louvre 2+2x73/80W T16	2986	9,890

Hole		
2x13/14W - 20/24W T16	189 x	616
2x19/21W - 34/39W T16	189 x	916
2x25/28W - 50/54W T16	189 x	1216
2x32/35W - 45/49W T16	189 x	1516
2x73/80W T16	189 x	1516
2+2x25/28W - 50/54W T16	189 x	2392
2+2x32/35W - 45/49W T16	189 x	2992
2+2x73/80W T16	189 x	2992

CE IP 43

T16

OSRAM: IS PHILIPS: T16

Included

Colour Codes:

0	Colours	1	White	2	Titan	3	Black
---	---------	---	-------	---	-------	---	-------

STREAMLIGHT TRIMLESS

STREAMLIGHT TRIMLESS + Module 60 POSIDON HI-PAR 111



CE	F	850°C	IP 20
70°	350°		
OSRAM HI-PAR 111 PHILIPS COB-A 111			Included

- Version for HI-PAR 111/GX8,5.
- Outer adjustable ring from die-cast aluminium.
- Inner ring for easy lamp replacement.

Code	Description	L	Kg
95315	Streamlight Trimless Module 60 POSIDON 35W HI-PAR 111/GX8,5	350	1,270
95316	Streamlight Trimless Module 60 POSIDON 70W HI-PAR 111/GX8,5	350	1,270

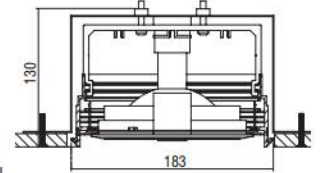

STREAMLIGHT TRIMLESS + Module 60 DIONISOS QR111



CE	F	850°C	IP 20
70°	350°		
OSRAM HALOPOT 111 PHILIPS ACALINE 111			Included

- Version for QR111/G53.
- Outer adjustable ring from die-cast aluminium.
- Inner ring for easy lamp replacement.

Code	Description	L	Kg
95317	Streamlight Trimless Module 60 DIONISOS max.70W QR111/G53	350	1,270

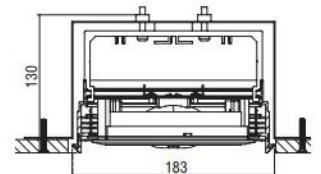

STREAMLIGHT TRIMLESS + Module 60 APOLLON HIT-CE



CE	F	850°C	IP 20
70°	350°		
OSRAM HIT-T PHILIPS COB-T			Included

- Version for HIT-CE/G12.
- Outer adjustable ring from die-cast aluminium.
- Inner ring for easy lamp replacement.
- High pure aluminium reflectors in Spot, Medium, Wide.
- Tempered protection glass.

Code	Description	L	Kg
95319	Streamlight Trimless Module 60 APOLLON 35W HIT-CE/G12 S	350	1,270
95320	Streamlight Trimless Module 60 APOLLON 35W HIT-CE/G12 M	350	1,270
95321	Streamlight Trimless Module 60 APOLLON 35W HIT-CE/G12 W	350	1,270
95322	Streamlight Trimless Module 60 APOLLON 70W HIT-CE/G12 S	350	1,270
95323	Streamlight Trimless Module 60 APOLLON 70W HIT-CE/G12 M	350	1,270
95324	Streamlight Trimless Module 60 APOLLON 70W HIT-CE/G12 W	350	1,270

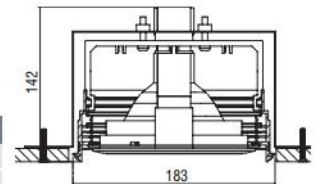

STREAMLIGHT TRIMLESS + Module 60 IFESTOS HIT-TC-CE



CE	F	850°C	IP 20
70°	350°		
OSRAM HIT-TC PHILIPS COB-TC			Included

- Version for HIT-TC-CE/G8,5.
- Outer adjustable ring from die-cast aluminium.
- Inner ring for easy lamp replacement.
- High pure aluminium reflectors in Spot, Medium, Wide.
- Tempered protection glass.

Code	Description	L	Kg
95325	Streamlight Trimless Module 60 IFESTOS 35W HIT-TC-CE/G8,5 S	350	1,270
95326	Streamlight Trimless Module 60 IFESTOS 35W HIT-TC-CE/G8,5 M	350	1,270
95327	Streamlight Trimless Module 60 IFESTOS 35W HIT-TC-CE/G8,5 W	350	1,270
95328	Streamlight Trimless Module 60 IFESTOS 70W HIT-TC-CE/G8,5 S	350	1,270
95329	Streamlight Trimless Module 60 IFESTOS 70W HIT-TC-CE/G8,5 M	350	1,270
95330	Streamlight Trimless Module 60 IFESTOS 70W HIT-TC-CE/G8,5 W	350	1,270

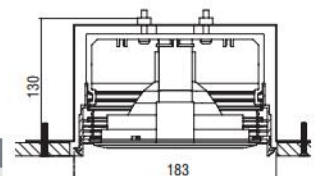



STREAMLIGHT TRIMLESS

STREAMLIGHT TRIMLESS + Module 60 ARIS LED R111



CE	F	850°C	IP 20
60°	350°		
LED			

- Version for LED R111/GU10.
- Outer adjustable ring from die-cast aluminium.
- Inner ring for easy lamp replacement.
- Connection for 230V/50Hz.

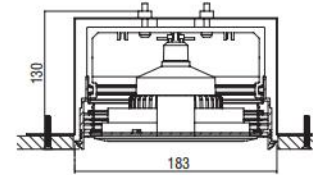

Code	Description	L	Kg
95318	Streamlight Trimless Module 60 ARIS LED R111/GU10/230V	350	1,270

STREAMLIGHT TRIMLESS + Module 60 DIAS LED



CE	F	850°C	IP 20
60°	350°		
LED	LED chip substrate	ta 25°C	Included

- Version with LED Module.
  - Outer adjustable ring from die-cast aluminium.
  - 22W power consumption driven at 500mA.
  - 30W power consumption driven at 700mA.
  - Efficiency:
- |                   |         |                          |
|-------------------|---------|--------------------------|
| 22W:              | 4000 K: | 2440 Lumen, CRI: min. 80 |
| 22W:              | 3000 K: | 2331 Lumen, CRI: min. 80 |
| 30W:              | 4000 K: | 3290 Lumen, CRI: min. 80 |
| 30W:              | 3000 K: | 3143 Lumen, CRI: min. 80 |
| Maximum: 111 Lm/W |         |                          |

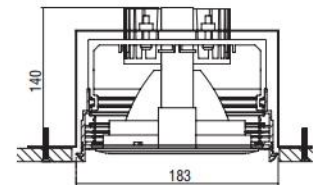

Code	Description	L	Kg
95331	Streamlight Trimless Module 60 DIAS LED CHIP 22W	350	1,270
95332	Streamlight Trimless Module 60 DIAS LED CHIP 30W	350	1,270

STREAMLIGHT TRIMLESS + Module 60 KRONOS HIT-TC-CE



CE	F	850°C	IP 20
60°	350°		
HIT-TC-CE/GU6,5			Included

- Version for HIT-TC-CE/GU6,5.
- Outer adjustable ring from die-cast aluminium.
- Die-cast aluminium spot inside.
- High pure aluminium reflectors in Spot, Medium, Wide.
- Tempered protection glass.

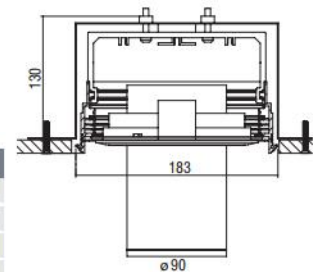

Code	Description	L	Kg
95333	Streamlight Trimless Module 60 KRONOS 20W HIT-TC-CE /GU6,5 S	350	1,170
95334	Streamlight Trimless Module 60 KRONOS 20W HIT-TC-CE /GU6,5 M	350	1,170
95335	Streamlight Trimless Module 60 KRONOS 20W HIT-TC-CE /GU6,5 W	350	1,170
95336	Streamlight Trimless Module 60 KRONOS 35W HIT-TC-CE /GU6,5 S	350	1,170
95337	Streamlight Trimless Module 60 KRONOS 35W HIT-TC-CE /GU6,5 M	350	1,170
95338	Streamlight Trimless Module 60 KRONOS 35W HIT-TC-CE /GU6,5 W	350	1,170

STREAMLIGHT TRIMLESS + Module 60 KRONOS LED



CE	F	850°C	IP 20
60°	350°		
LED	LED chip substrate	ta 25°C	Included

- Version with LED Module.
  - Outer adjustable ring from die-cast aluminium.
  - Die-cast aluminium spot inside.
  - 22W power consumption driven at 500mA.
  - Efficiency:
- |                   |         |                          |
|-------------------|---------|--------------------------|
| 22W:              | 4000 K: | 2440 Lumen, CRI: min. 80 |
| 22W:              | 3000 K: | 2331 Lumen, CRI: min. 80 |
| Maximum: 111 Lm/W |         |                          |

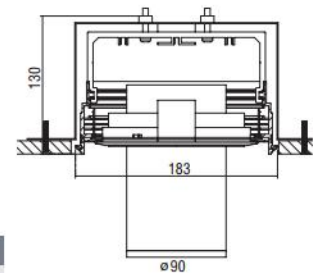

Code	Description	L	Kg
95339	Streamlight Trimless Module 60 KRONOS LED CHIP 22W	350	1,170

STREAMLIGHT TRIMLESS

STREAMLIGHT TRIMLESS + Module 40 THETIS HIT-TC-CE



CE	F	IP 20	
80°	350°		
HIT-TC-CE/GU6,5			Included
OSRAM, HELIX, PHILIPS, COB Tri			

- Version for HIT-TC-CE/GU6,5.
- Reflector: Spot, Medium, Wide.
- Tempered protection glass.

Code	Description	L	Kg
95341	Streamlight Trimless Module 40 THETIS 20W HIT-TC-CE/GU6,5 S	350	1,270
95342	Streamlight Trimless Module 40 THETIS 20W HIT-TC-CE/GU6,5 M	350	1,270
95343	Streamlight Trimless Module 40 THETIS 20W HIT-TC-CE/GU6,5 W	350	1,270
95344	Streamlight Trimless 2x Module 40 THETIS 20W HIT-TC-CE/GU6,5 S	550	1,990
95345	Streamlight Trimless 2x Module 40 THETIS 20W HIT-TC-CE/GU6,5 M	550	1,990
95346	Streamlight Trimless 2x Module 40 THETIS 20W HIT-TC-CE/GU6,5 W	550	1,990
95347	Streamlight Trimless Module 40 THETIS 35W HIT-TC-CE/GU6,5 S	350	1,270
95348	Streamlight Trimless Module 40 THETIS 35W HIT-TC-CE/GU6,5 M	350	1,270
95349	Streamlight Trimless Module 40 THETIS 35W HIT-TC-CE/GU6,5 W	350	1,270
95350	Streamlight Trimless 2x Module 40 THETIS 35W HIT-TC-CE/GU6,5 S	550	1,990
95351	Streamlight Trimless 2x Module 40 THETIS 35W HIT-TC-CE/GU6,5 M	550	1,990
95352	Streamlight Trimless 2x Module 40 THETIS 35W HIT-TC-CE/GU6,5 W	550	1,990

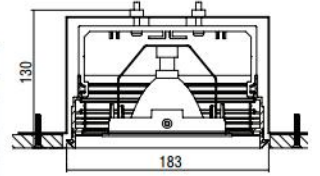

STREAMLIGHT TRIMLESS + Module 40 HERCULES LED REFLECTOR



CE	F	850°C	IP 20
80°	350°		
LED	ta 25°C		Included

- Reflectors: Spot, Medium, Wide.
- 12W power consumption driven at 350mA.
- Efficiency:  
12W: 4000 K: 1758 Lumen, CRI: min. 80  
12W: 3000 K: 1680 Lumen, CRI: min. 80  
Maximum: 147 Lm/W

Code	Description	L	Kg
95353	Streamlight Trimless Module 40 HERCULES LED REFLECTOR 12W	350	1,270
95354	Streamlight Trimless 2x Module 40 HERCULES LED REFLECTOR 12W	550	1,990

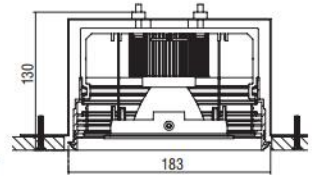

STREAMLIGHT TRIMLESS + Module 40 IASON LED REFLECTOR HO



CE	F	850°C	IP 20
80°	350°		
LED	ta 25°C		Included

- Reflectors: Spot, Medium, Wide.
- 12W power consumption driven at 350mA.
- Efficiency:  
12W: 4000 K: 1758 Lumen, CRI: min. 80  
12W: 3000 K: 1680 Lumen, CRI: min. 80  
Maximum: 147 Lm/W

Code	Description	L	Kg
95355	Streamlight Trimless Module 40 IASON LED REFLECTOR HO 12W	350	1,270
95356	Streamlight Trimless 2x Module 40 IASON LED REFLECTOR HO 12W	550	1,990

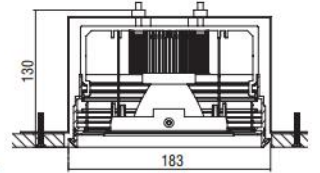

LED COLOUR CODES:

2 Warm 3 Neutral

BEAM CODES:

01 spot 02 medium 03 wide 04 spot HO 05 medium HO 06 wide HO

Colour Codes:

0 Colours 1 White 2 Titan 3 Black

STREAMLIGHT TRIMLESS ACCESSORIES

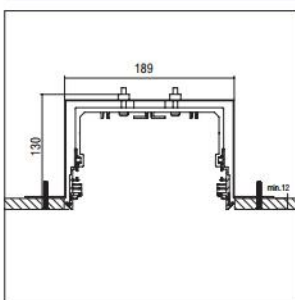

CE			
----	--	--	--

- Metal suspension bracket.
- Required 1pc per 0,5m profile length.

Code	Description	Kg
900810	Suspension Bracket Streamlight Trimless	0,270